

*Palestine Polytechnic University
College of Engineering and Technology
Electrical Engineering Department*

Graduation Project:

*Electrical System, Lighting and Supporting Works
Design for
Commercial Mall in Hebron*

Designed by:

*Marwa Abu Monefi
Israa Hasanat
Hind Saafin*

Supervisor:

Dr. Fouad Zaro .

2021-2022

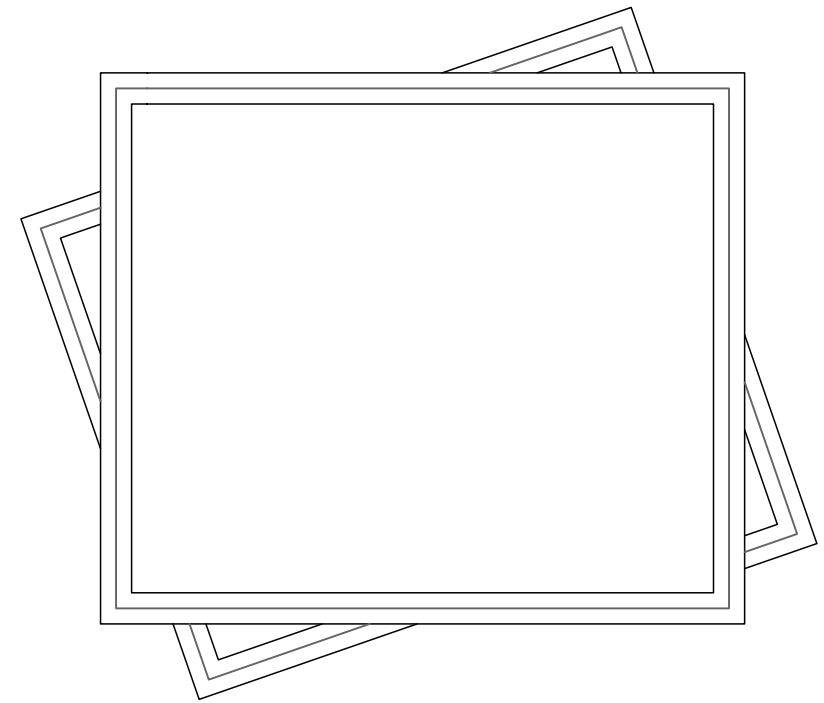

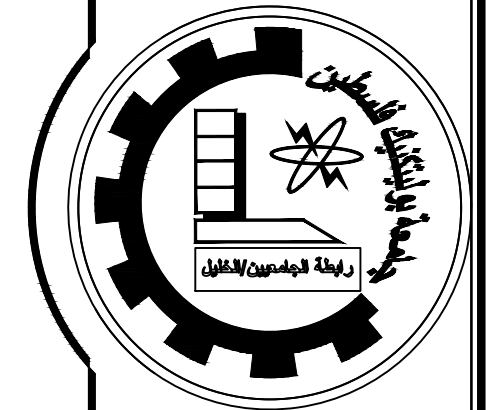
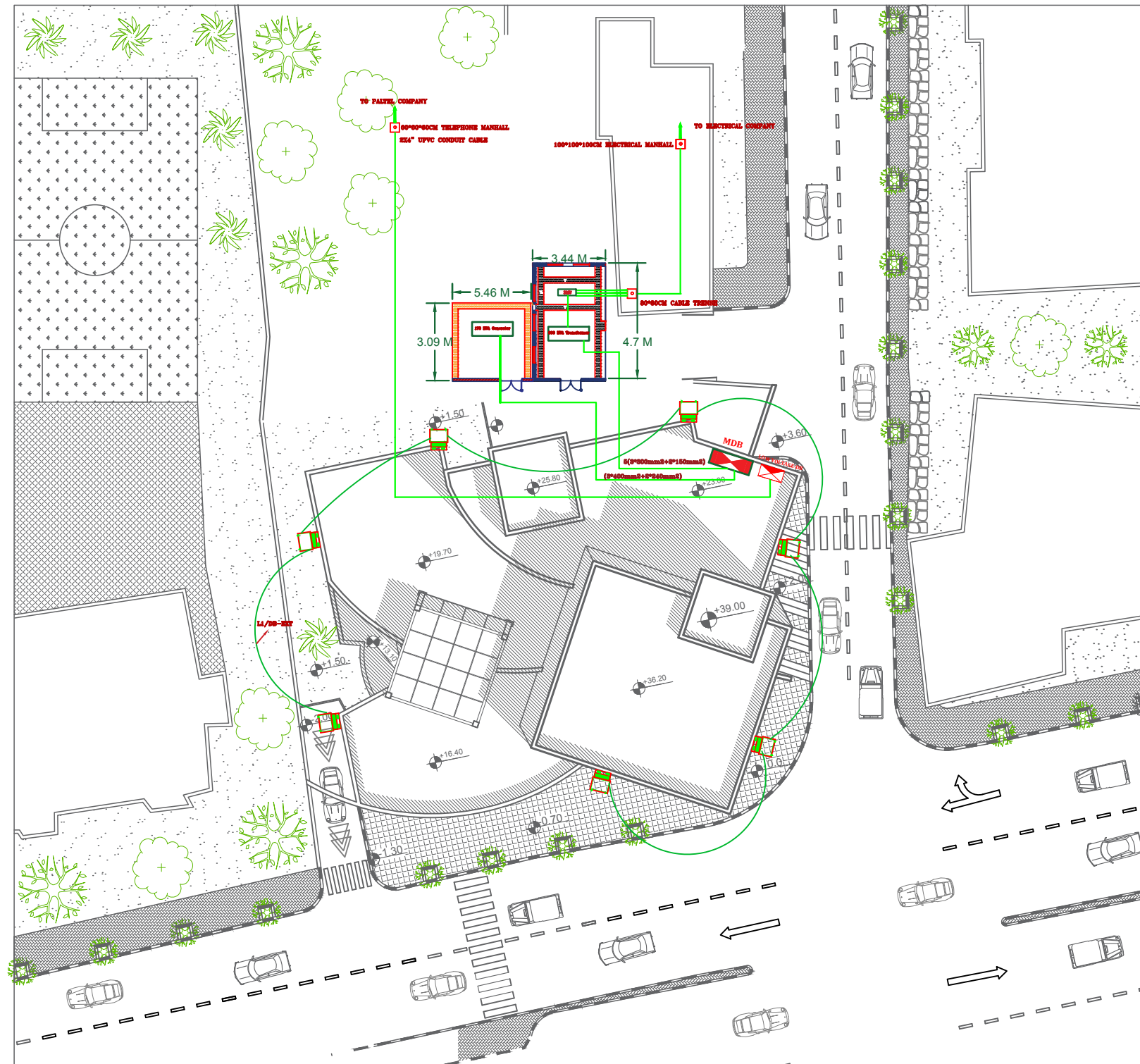

Palestine Polytechnic University
 College of Engineering
 Electrical Department
 Graduation Project

Project name :
 Electrical System, Lighting and
 Supporting Works Design for
 Commercial Mall in Hebron

Drawing Title :
 SITE PLAN

Students Desinger:
 Marwa Abu Monefi
 Israa Hasanat
 Hind Saafin

Supervisor :
 Dr. Fouad Zaro

SCALE	1/100
Sheet Number	EL - 01
All Dimensions Are In Meters Unless Otherwise Shown. All Spot Levels Are In Meters.	
DATE: 2021/ 2022	

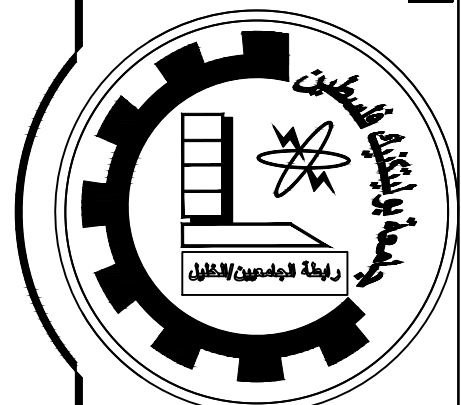
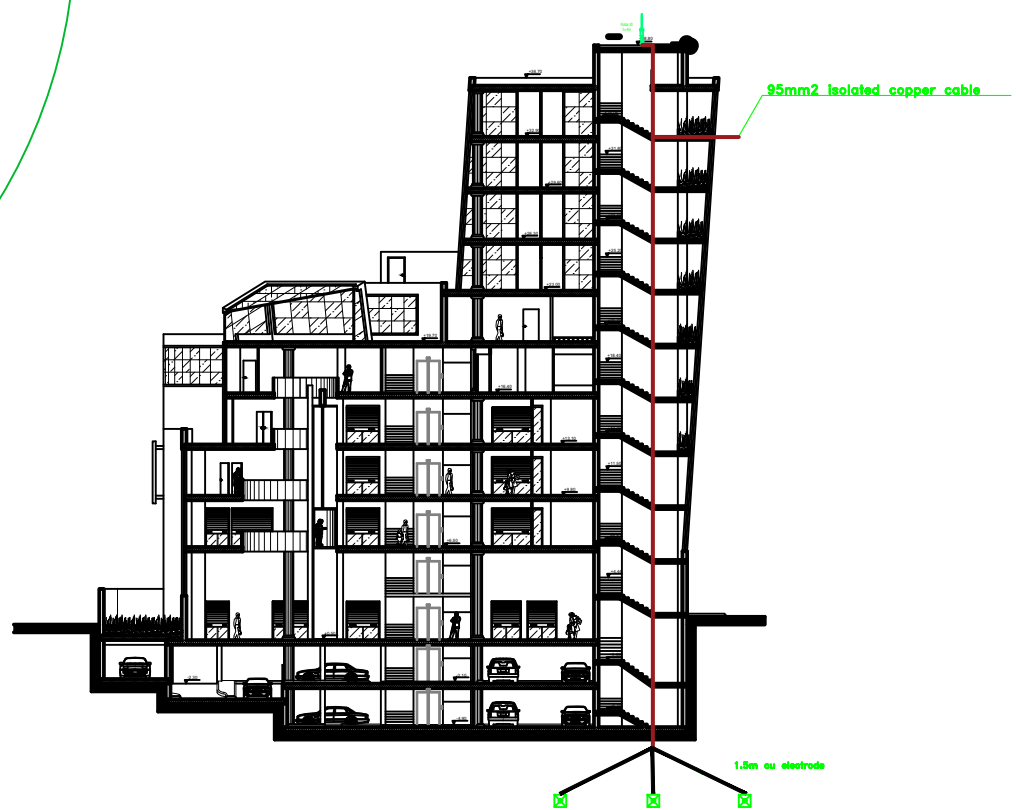
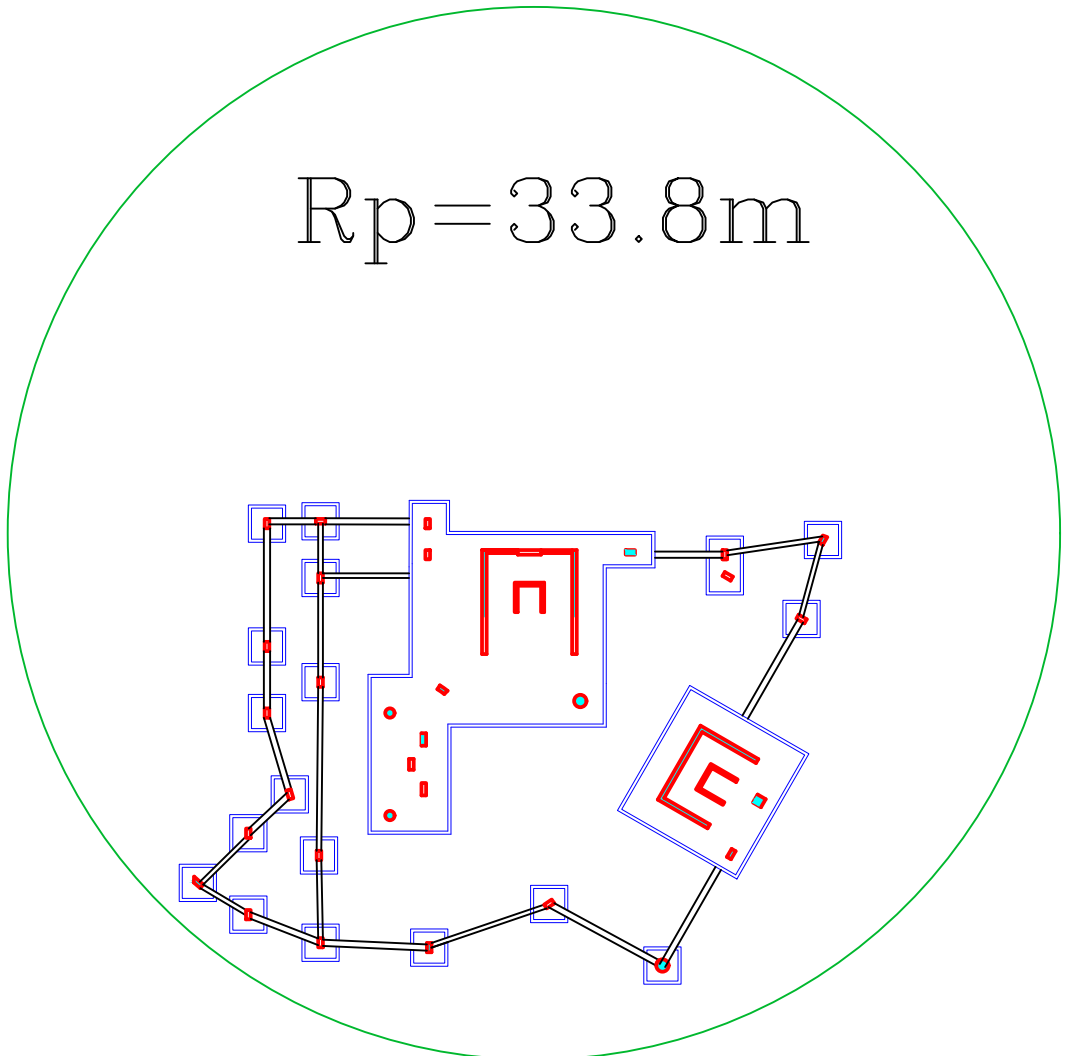

Palestine Polytechnic University
 College of Engineering
 Electrical Department
 Graduation Project

Project name :
 Electrical System, Lighting and
 Supporting Works Design for
 Commercial Mall in Hebron

Drawing Title :
 Lightning

Students Desinger:
 Marwa Abu Monefi
 Israa Hasanat
 Hind Saafin

Supervisor :
 Dr. Fouad Zaro

SCALE	1/100
Sheet Number	EL-02
All Dimensions Are In Meters Unless Otherwise Shown. All Spot Levels Are In Meters.	
DATE: 2021/ 2022	

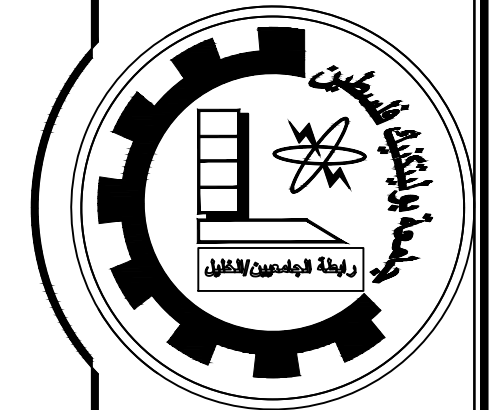

Palestine Polytechnic University
College of Engineering
Electrical Department
Graduation Project

Project name :
Electrical System, Lighting and
Supporting Works Design for
Commercial Mall in Hebron

Drawing Title :
Earthing System

Students Desinger:
Marwa Abu Monefi
Israa Hasanat
Hind Saafin

Supervisor :
Dr. Fouad Zaro

SCALE	1/100
Sheet Number	EL-03
All Dimensions Are In Meters Unless Otherwise Shown. All Spot Levels Are In Meters.	
DATE: 2021/ 2022	

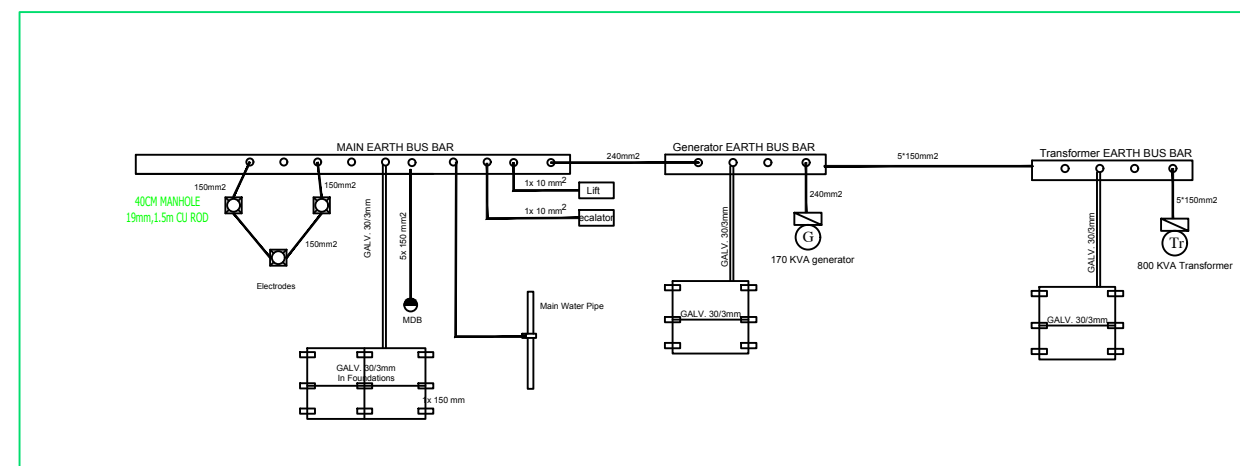

Earthing System Block Diagram

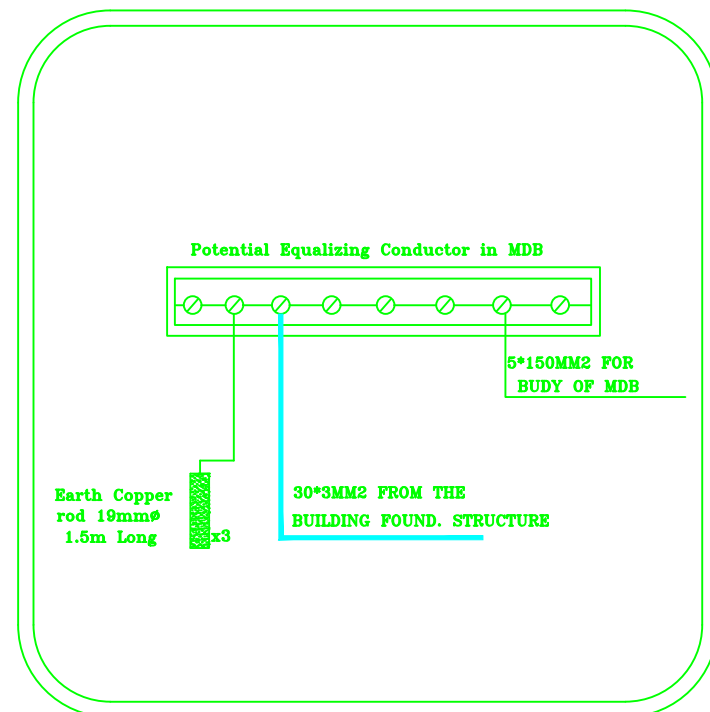

MAIN EARTH BUS BAR IN MDB

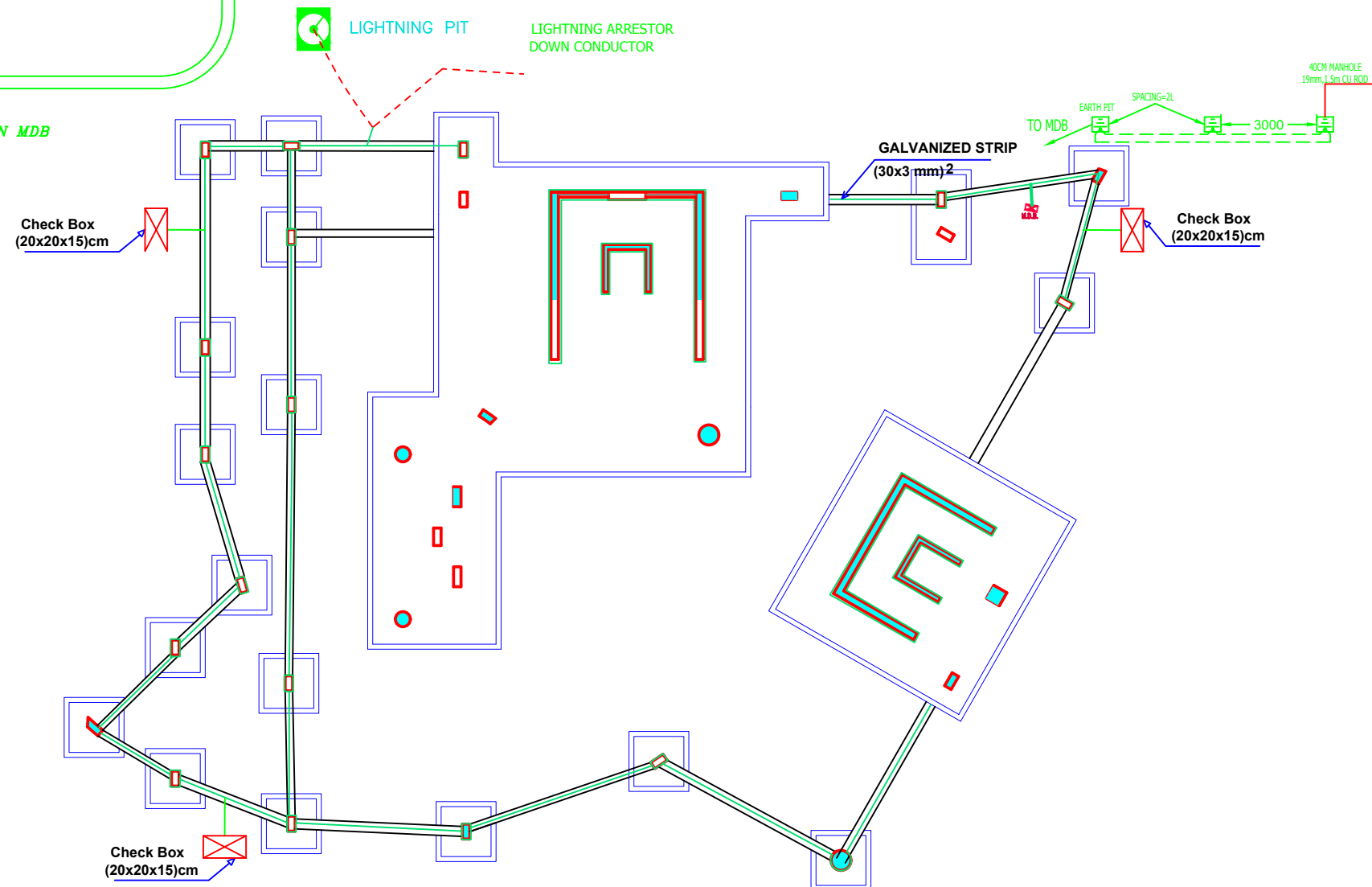

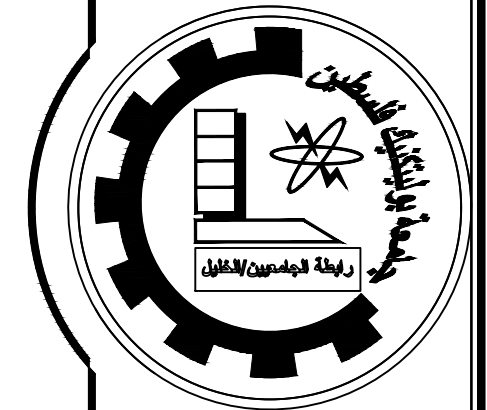

Palestine Polytechnic University
 College of Engineering
 Electrical Department
 Graduation Project

Project name :
 Electrical System, Lighting and
 Supporting Works Design for
 Commercial Mall in Hebron

Drawing Title :
 Lighting-Basement 1

Students Desinger:
 Marwa Abu Monefi
 Israa Hasanat
 Hind Saafin

Supervisor :
 Dr. Fouad Zaro

SCALE	1/100
Sheet Number	EL - 04
All Dimensions Are In Meters Unless Otherwise Shown. All Spot Levels Are In Meters.	
DATE: 2021/ 2022	

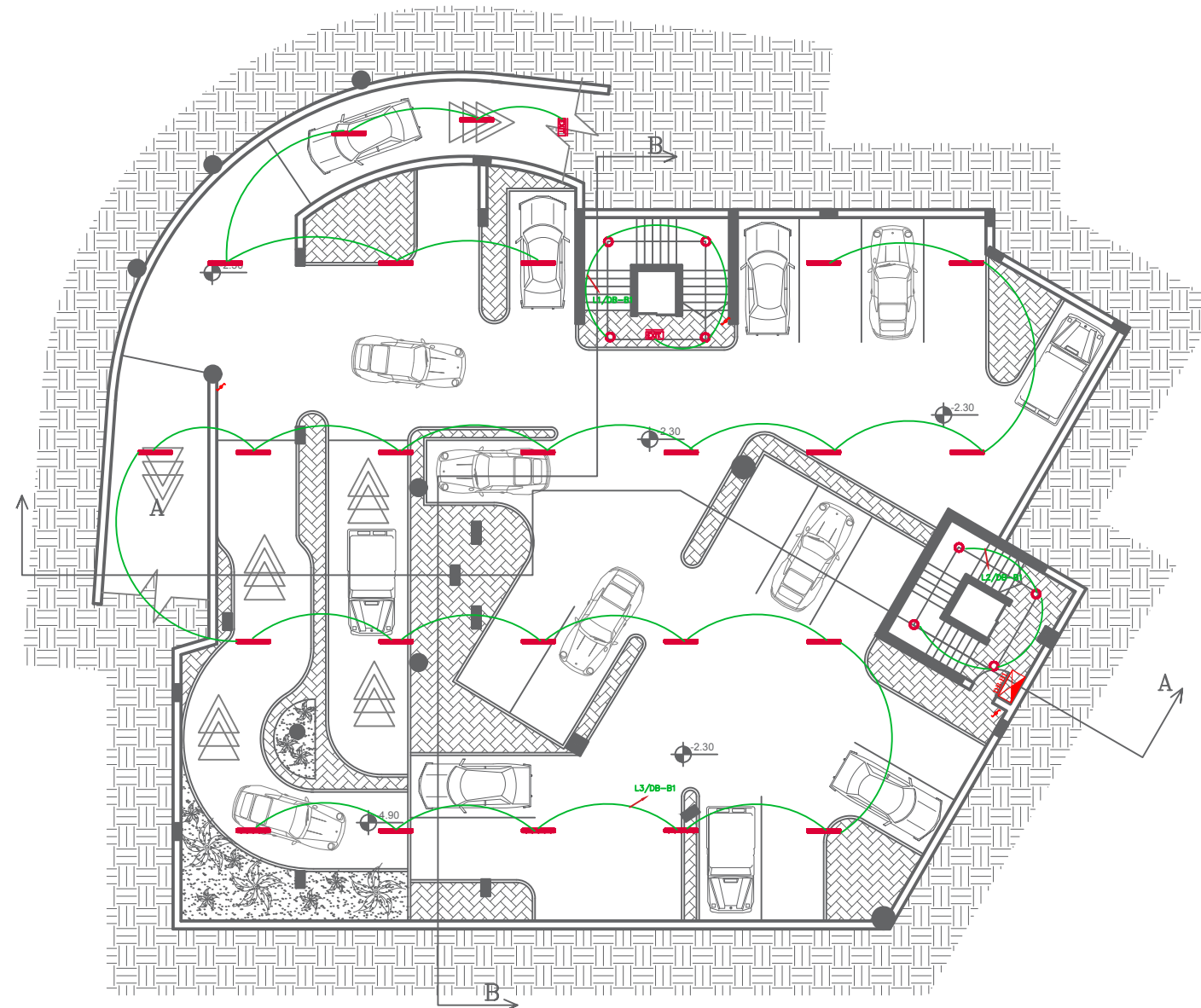

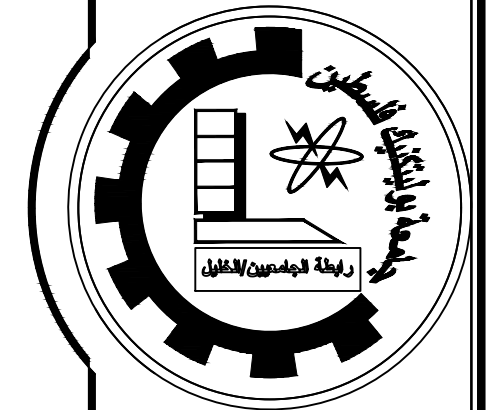

Palestine Polytechnic University
 College of Engineering
 Electrical Department
 Graduation Project

Project name :
 Electrical System, Lighting and
 Supporting Works Design for
 Commercial Mall in Hebron

Drawing Title :
 Lighting-Basement 2

Students Desinger:
 Marwa Abu Monefi
 Israa Hasanat
 Hind Saafin

Supervisor :
 Dr. Fouad Zaro

SCALE	1/100
Sheet Number	EL - 05
All Dimensions Are In Meters Unless Otherwise Shown. All Spot Levels Are In Meters.	
DATE: 2021/ 2022	

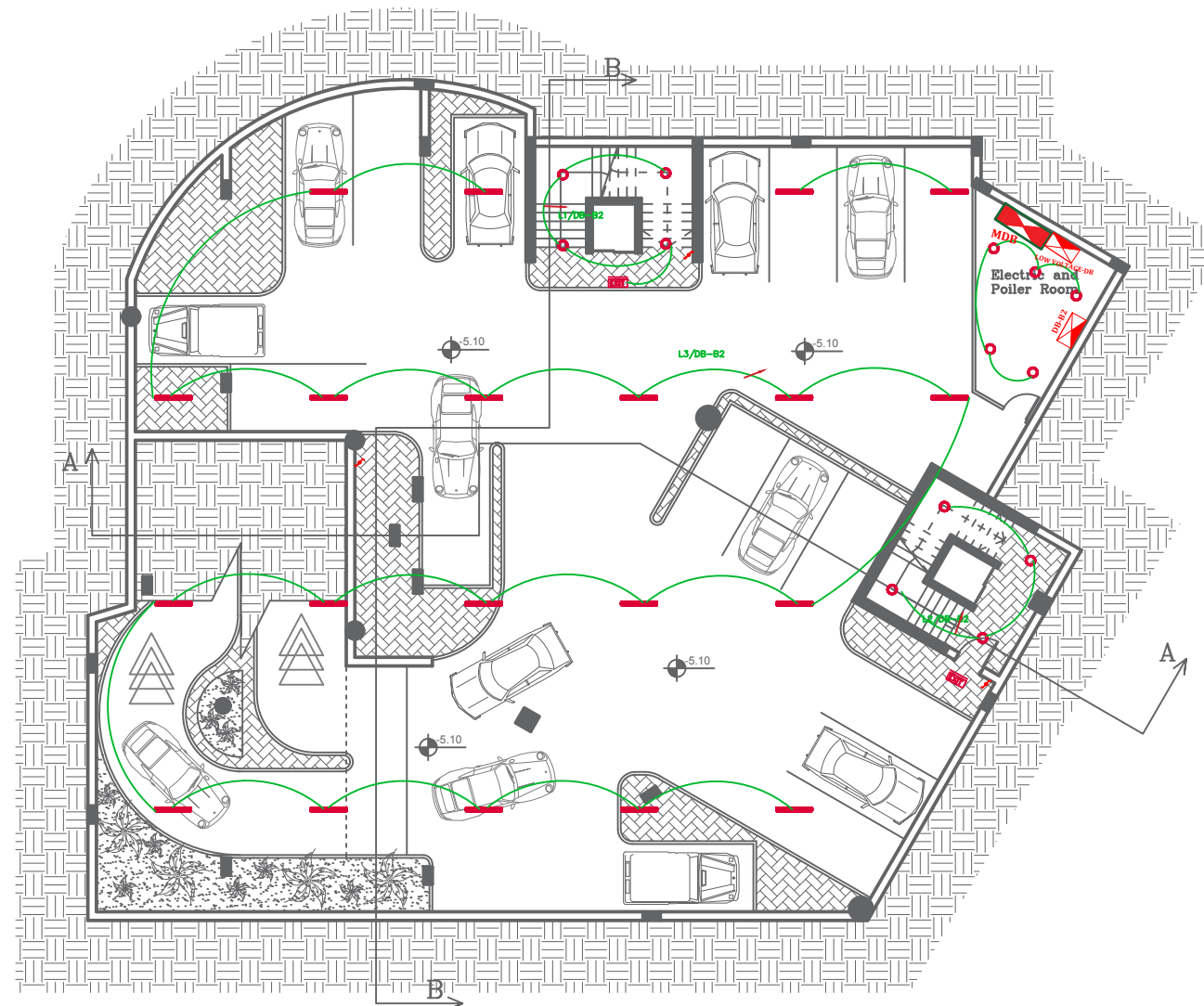

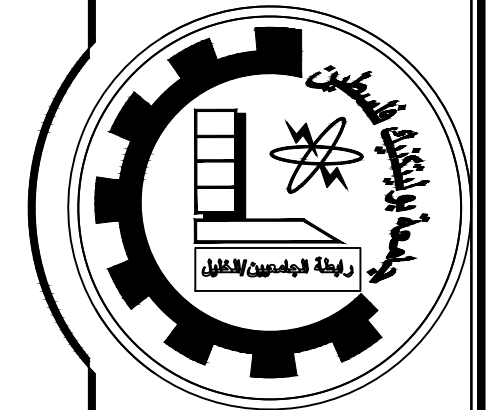

Palestine Polytechnic University
 College of Engineering
 Electrical Department
 Graduation Project

Project name :
 Electrical System, Lighting and
 Supporting Works Design for
 Commercial Mall in Hebron

Drawing Title :
 Lighting-Ground

Students Desinger:
 Marwa Abu Monefi
 Israa Hasanat
 Hind Saafin

Supervisor :
 Dr. Fouad Zaro

SCALE	1/100
Sheet Number	EL - 06
All Dimensions Are In Meters Unless Otherwise Shown. All Spot Levels Are In Meters.	
DATE: 2021/ 2022	

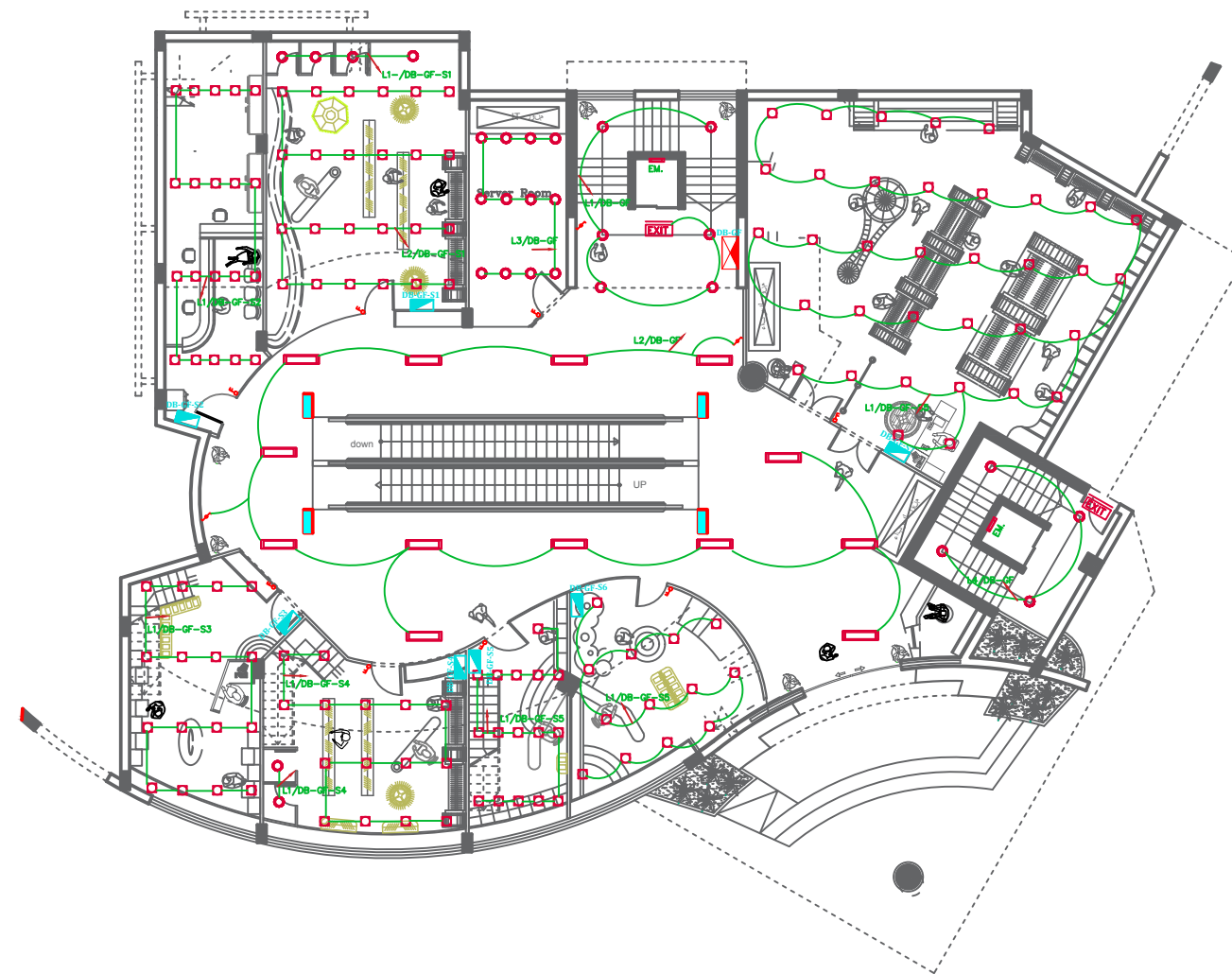

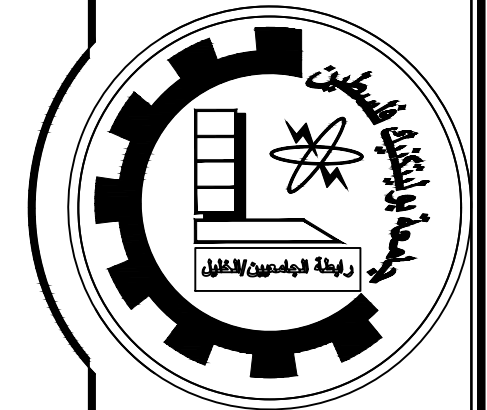

Palestine Polytechnic University
 College of Engineering
 Electrical Department
 Graduation Project

Project name :
 Electrical System, Lighting and
 Supporting Works Design for
 Commercial Mall in Hebron

Drawing Title :
 Lighting-first floor

Students Desinger:
 Marwa Abu Monefi
 Israa Hasanat
 Hind Saafin

Supervisor :
 Dr. Fouad Zaro

SCALE	1/100
Sheet Number	EL - 07
All Dimensions Are In Meters Unless Otherwise Shown. All Spot Levels Are In Meters.	
DATE: 2021/ 2022	

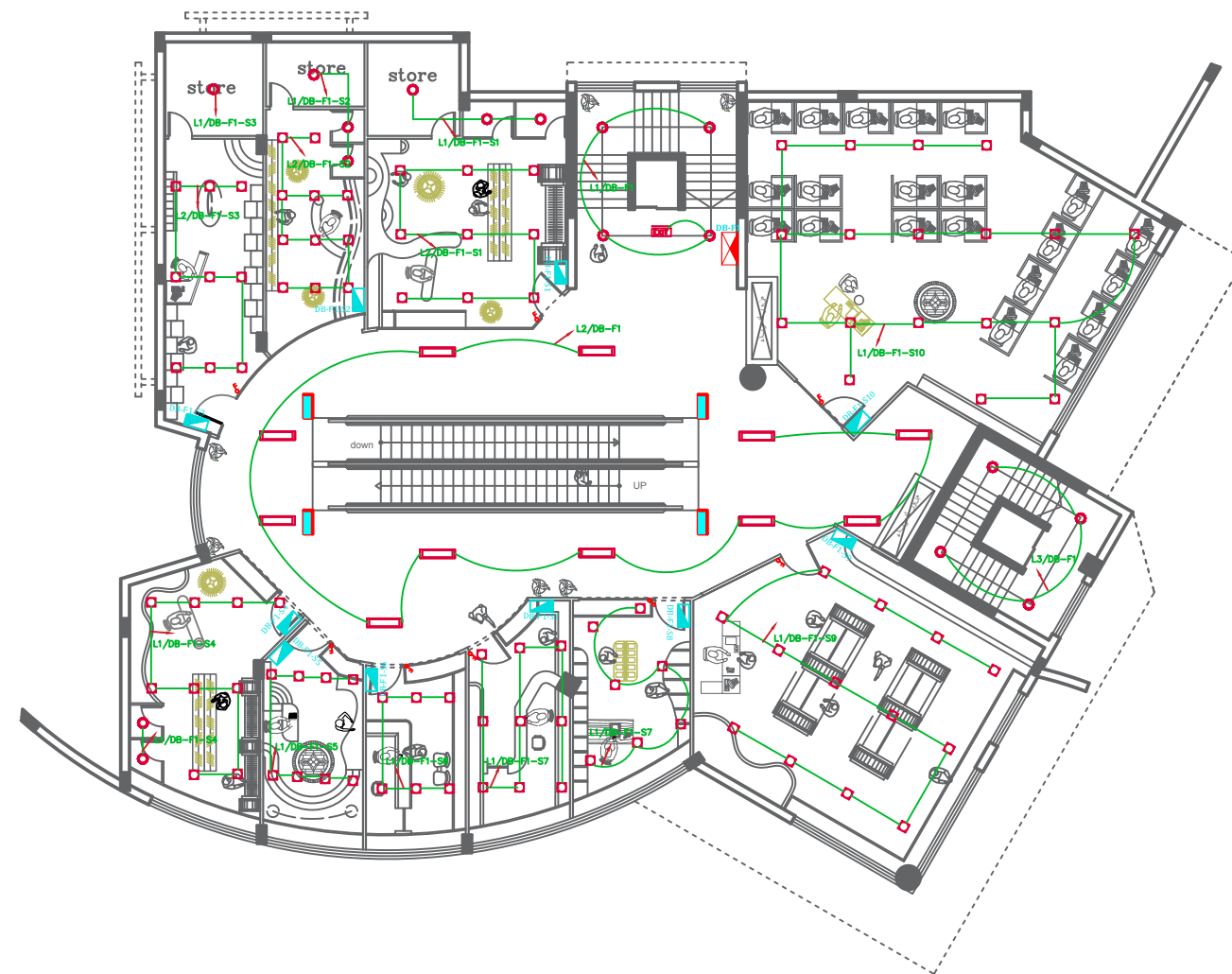

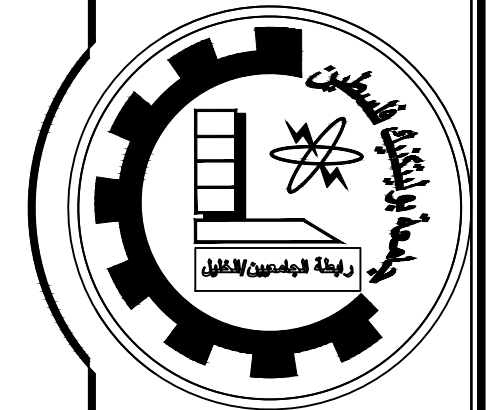

Palestine Polytechnic University
 College of Engineering
 Electrical Department
 Graduation Project

Project name :
 Electrical System, Lighting and
 Supporting Works Design for
 Commercial Mall in Hebron

Drawing Title :
 Lighting-second floor

Students Desinger:
 Marwa Abu Monefi
 Israa Hasanat
 Hind Saafin

Supervisor :
 Dr. Fouad Zaro

SCALE	1/100
Sheet Number	EL - 08
All Dimensions Are In Meters Unless Otherwise Shown. All Spot Levels Are In Meters.	
DATE: 2021/ 2022	

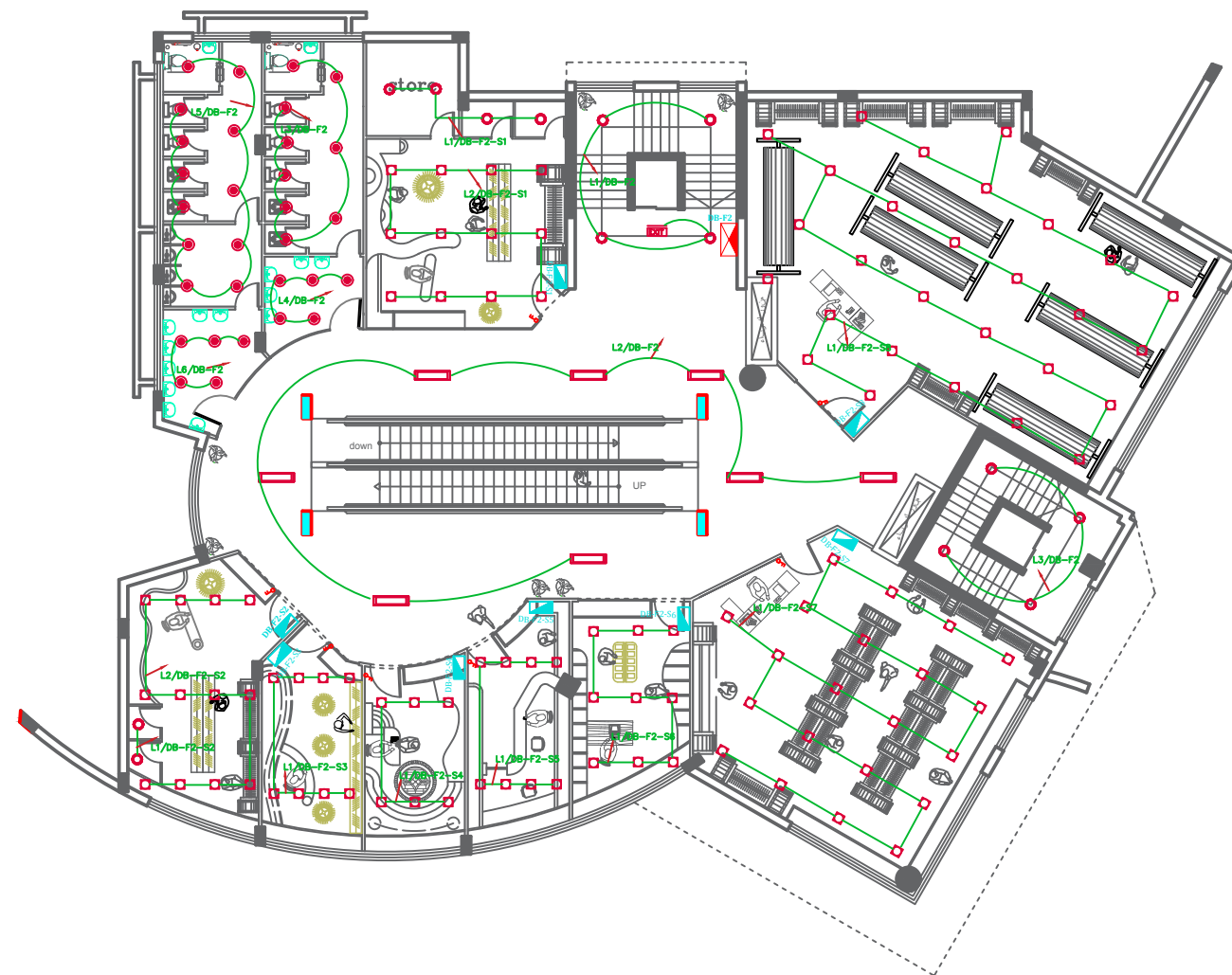

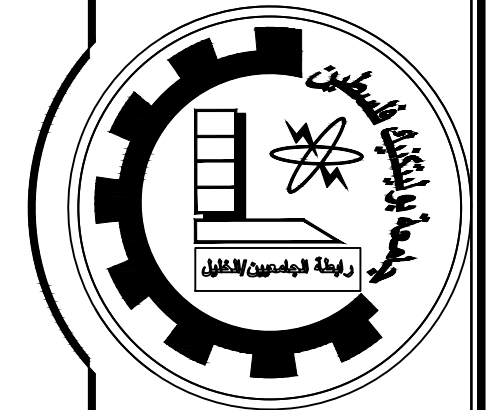

Palestine Polytechnic University
 College of Engineering
 Electrical Department
 Graduation Project

Project name :
 Electrical System, Lighting and
 Supporting Works Design for
 Commercial Mall in Hebron

Drawing Title :
 Lighting-third floor

Students Desinger:
 Marwa Abu Monefi
 Israa Hasanat
 Hind Saafin

Supervisor :
 Dr. Fouad Zaro

SCALE	1/100
Sheet Number	EL - 09
All Dimensions Are In Meters Unless Otherwise Shown. All Spot Levels Are In Meters.	
DATE: 2021/ 2022	

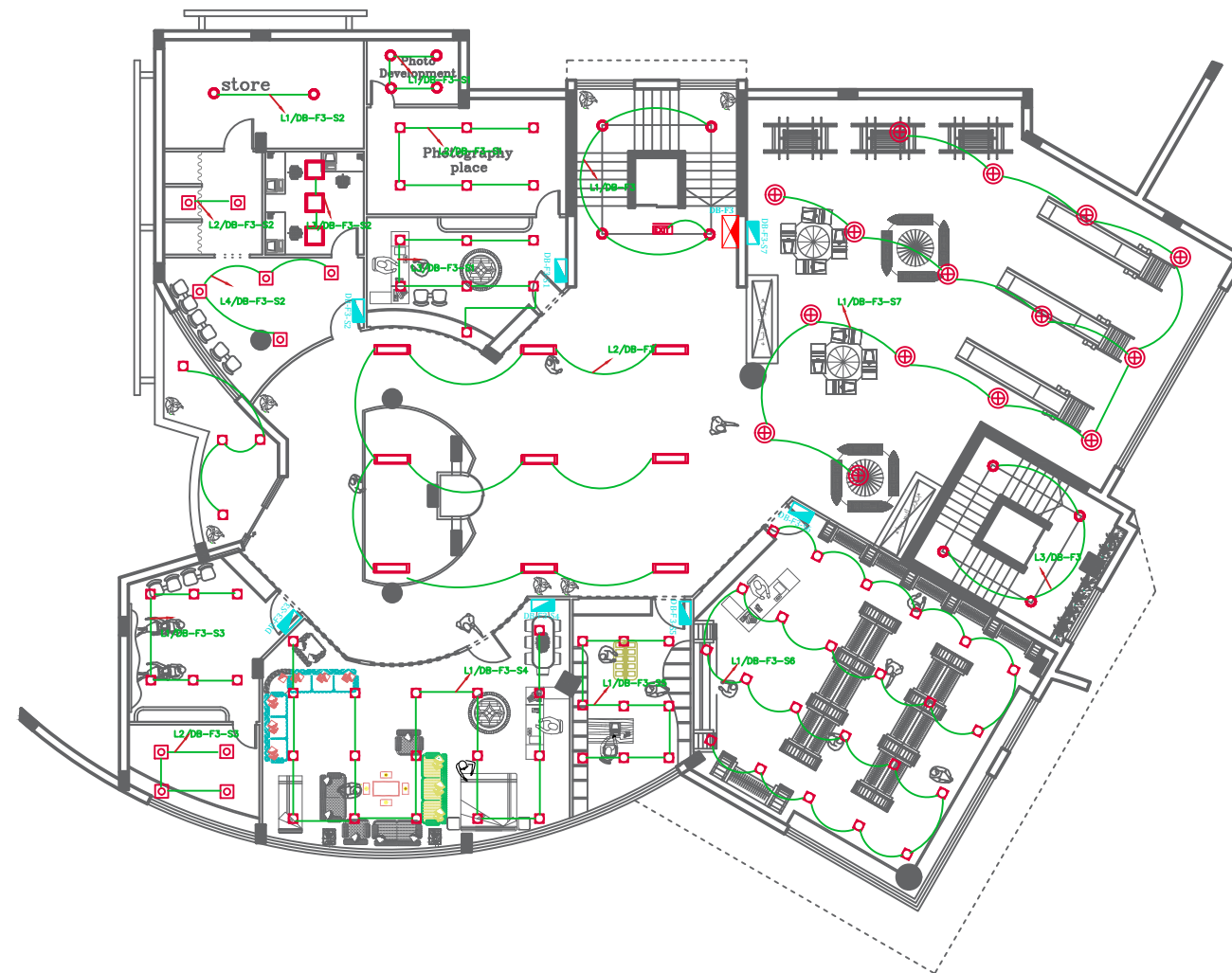

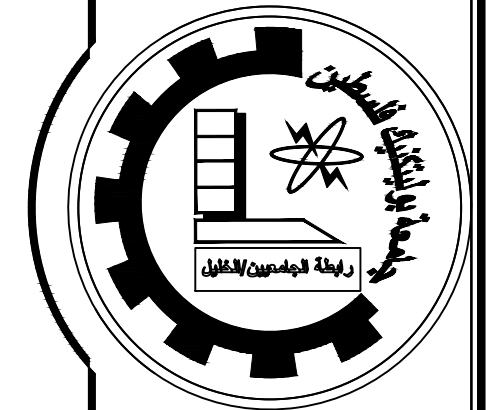

Palestine Polytechnic University
 College of Engineering
 Electrical Department
 Graduation Project

Project name :
 Electrical System, Lighting and
 Supporting Works Design for
 Commercial Mall in Hebron

Drawing Title :
 Lighting-fourth floor

Students Desinger:
 Marwa Abu Monefi
 Israa Hasanat
 Hind Saafin

Supervisor :
 Dr. Fouad Zaro

SCALE	1/100
Sheet Number	EL - 10
All Dimensions Are In Meters Unless Otherwise Shown. All Spot Levels Are In Meters.	
DATE: 2021/ 2022	

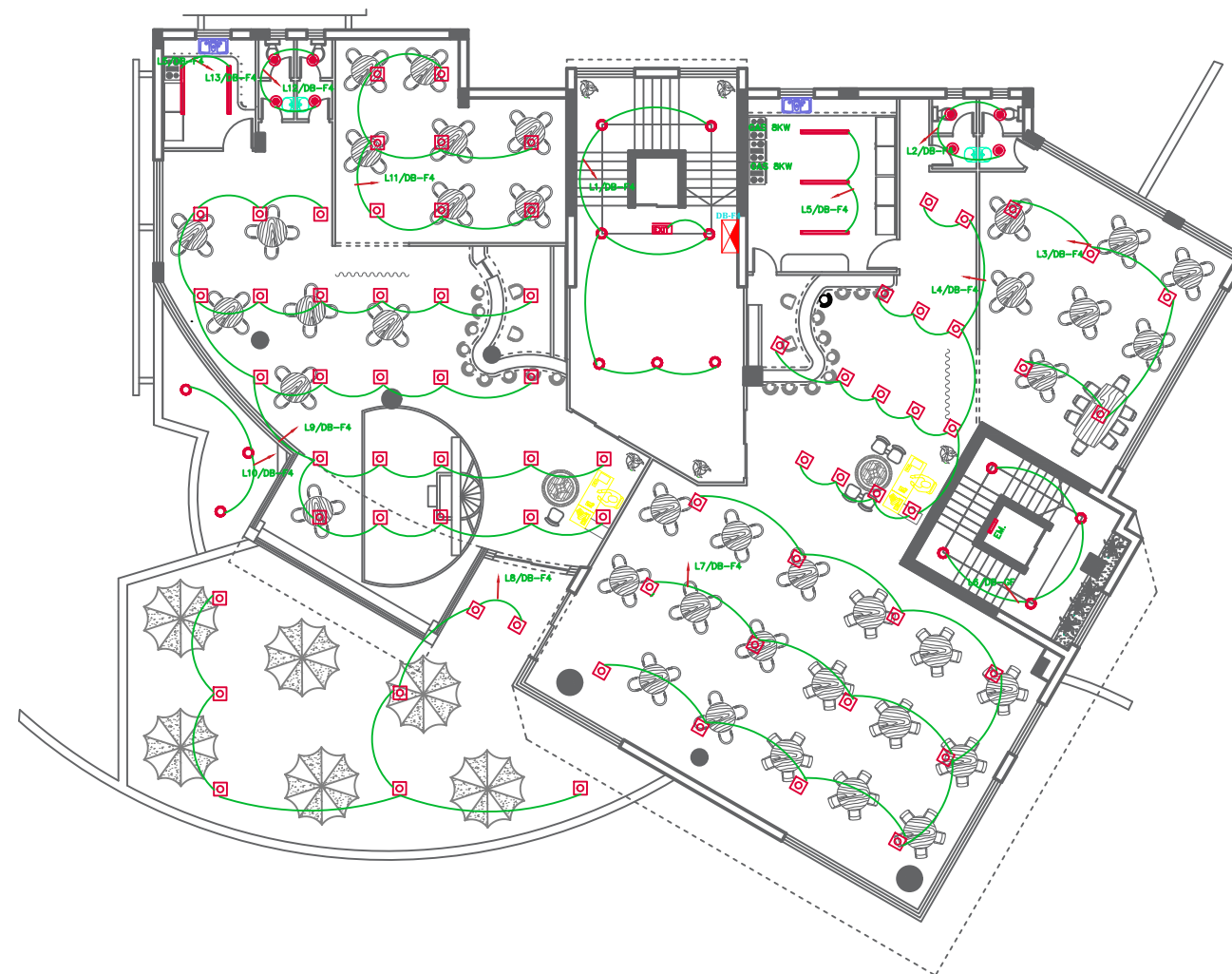

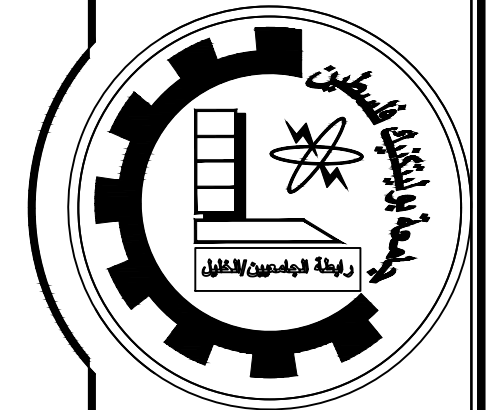

Palestine Polytechnic University
 College of Engineering
 Electrical Department
 Graduation Project

Project name :
 Electrical System, Lighting and
 Supporting Works Design for
 Commercial Mall in Hebron

Drawing Title :
 Lighting-fifth floor

Students Desinger:
 Marwa Abu Monefi
 Israa Hasanat
 Hind Saafin

Supervisor :
 Dr. Fouad Zaro

SCALE	1/100
Sheet Number	EL - 11
All Dimensions Are In Meters Unless Otherwise Shown. All Spot Levels Are In Meters.	
DATE: 2021/ 2022	



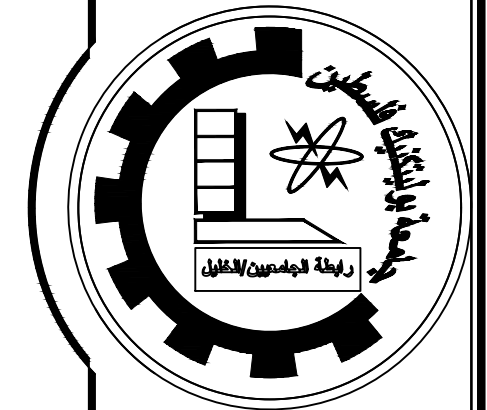

Palestine Polytechnic University
 College of Engineering
 Electrical Department
 Graduation Project

Project name :
 Electrical System, Lighting and
 Supporting Works Design for
 Commercial Mall in Hebron

Drawing Title :
 Lighting-sixth floor

Students Desinger:
 Marwa Abu Monefi
 Israa Hasanat
 Hind Saafin

Supervisor :
 Dr. Fouad Zaro

SCALE	1/100
Sheet Number	EL - 12
All Dimensions Are In Meters Unless Otherwise Shown. All Spot Levels Are In Meters.	
DATE: 2021/ 2022	

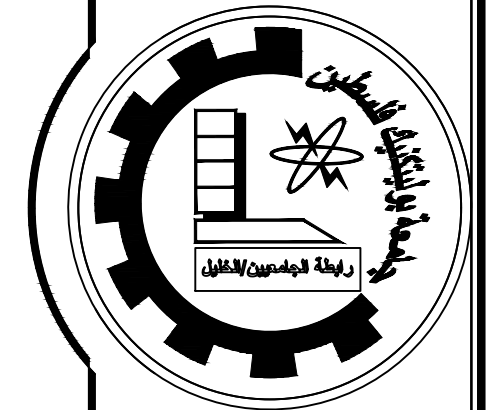

Palestine Polytechnic University
College of Engineering
Electrical Department
Graduation Project

Project name :

Electrical System, Lighting and
Supporting Works Design for
Commercial Mall in Hebron

Drawing Title :
Lighting-seventh floor

Students Desinger:

Marwa Abu Monefi
Israa Hasanat
Hind Saafin

Supervisor :

Dr. Fouad Zaro

SCALE 1/100

Sheet Number EL - 13

All Dimensions Are In Meters
Unless Otherwise Shown.
All Spot Levels Are In Meters.

DATE: 2021/ 2022



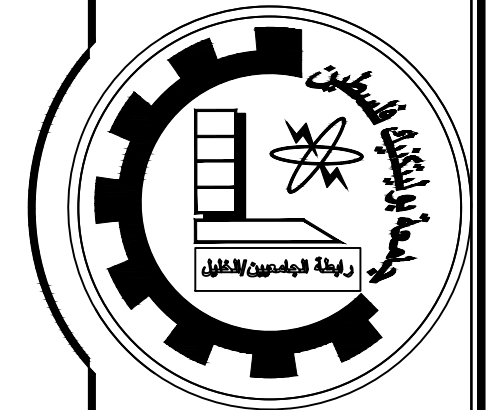

Palestine Polytechnic University
 College of Engineering
 Electrical Department
 Graduation Project

Project name :
 Electrical System, Lighting and
 Supporting Works Design for
 Commercial Mall in Hebron

Drawing Title :
 Lighting-eighth floor

Students Desinger:
 Marwa Abu Monefi
 Israa Hasanat
 Hind Saafin

Supervisor :
 Dr. Fouad Zaro

SCALE	1/100
Sheet Number	EL - 14
All Dimensions Are In Meters Unless Otherwise Shown. All Spot Levels Are In Meters.	
DATE: 2021/ 2022	

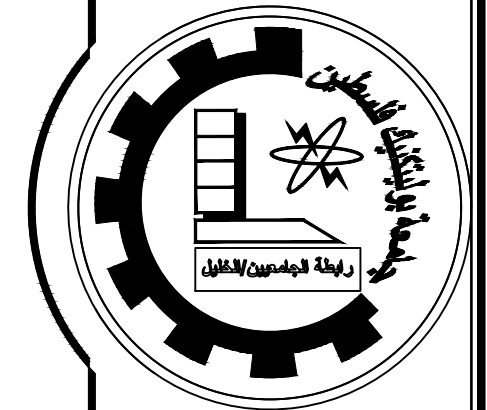

Palestine Polytechnic University
 College of Engineering
 Electrical Department
 Graduation Project

Project name :
 Electrical System, Lighting and
 Supporting Works Design for
 Commercial Mall in Hebron

Drawing Title :
 Lighting-ninth floor

Students Desinger:
 Marwa Abu Monefi
 Israa Hasanat
 Hind Saafin

Supervisor :
 Dr. Fouad Zaro

SCALE	1/100
Sheet Number	EL - 15
All Dimensions Are In Meters Unless Otherwise Shown. All Spot Levels Are In Meters.	
DATE: 2021/ 2022	

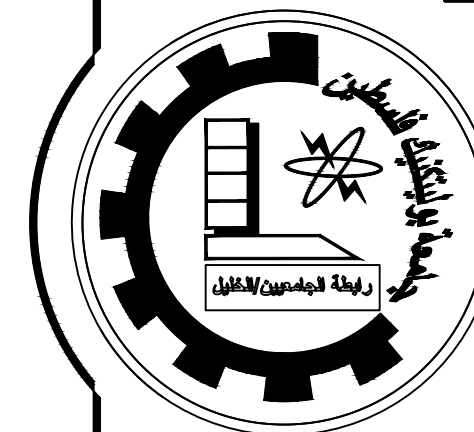

Palestine Polytechnic University
 College of Engineering
 Electrical Department
 Graduation Project

Project name :
 Electrical System, Lighting and
 Supporting Works Design for
 Commercial Mall in Hebron

Drawing Title :
 POWER-Basement 1

Students Desinger:
 Marwa Abu Monefi
 Israa Hasanat
 Hind Saafin

Supervisor :
 Dr. Fouad Zaro

SCALE	1/100
Sheet Number	EL - 16
All Dimensions Are In Meters Unless Otherwise Shown. All Spot Levels Are In Meters.	
DATE: 2021/ 2022	

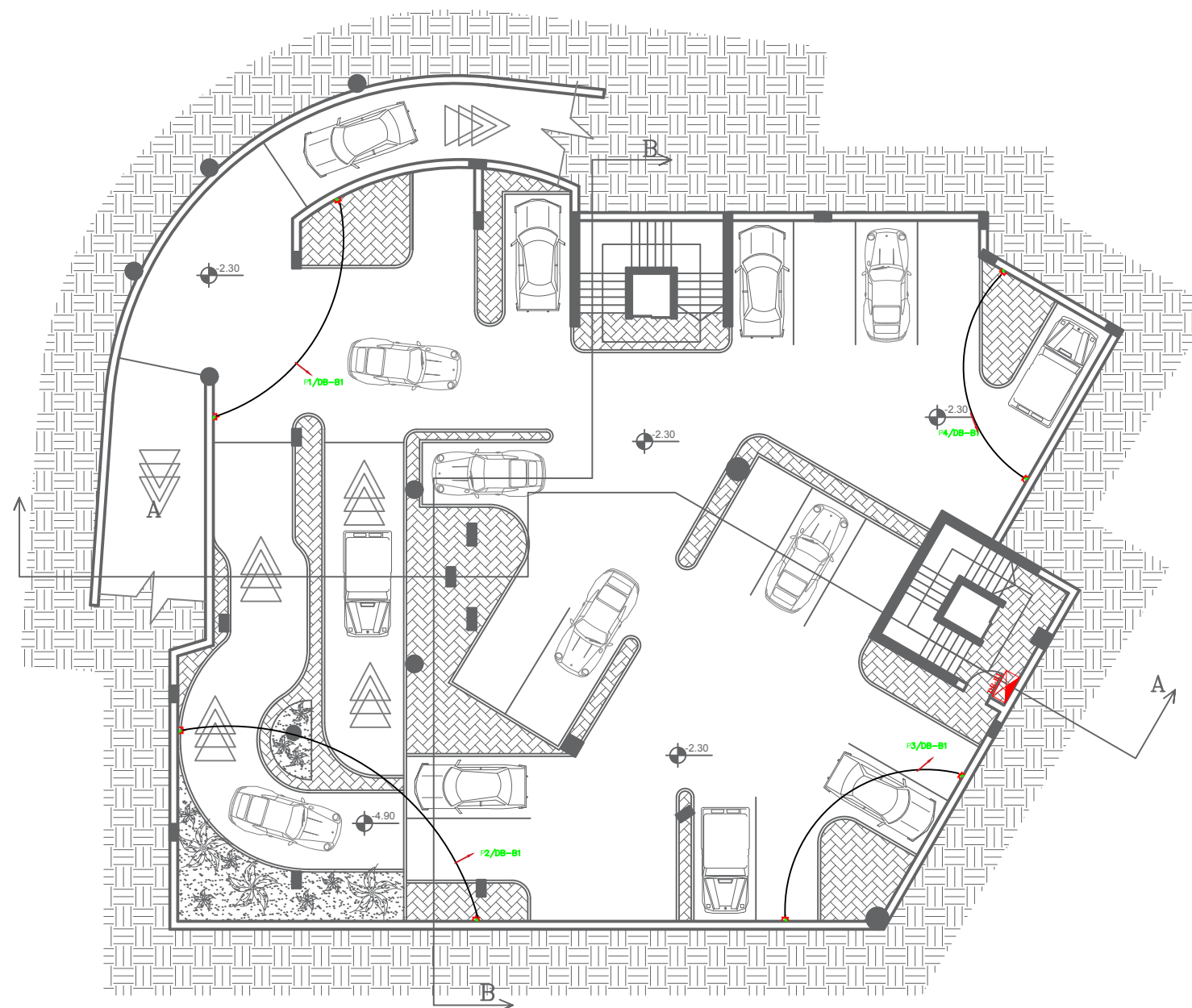

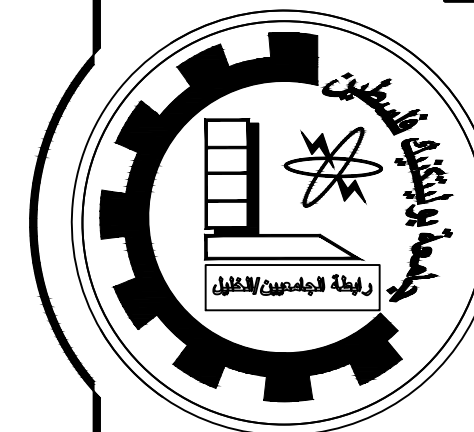

Palestine Polytechnic University
 College of Engineering
 Electrical Department
 Graduation Project

Project name :
 Electrical System, Lighting and
 Supporting Works Design for
 Commercial Mall in Hebron

Drawing Title :
 POWER-Basement 2

Handwritten signature

Students Desinger:
 Marwa Abu Monefi
 Israa Hasanat
 Hind Saafin

Supervisor :
 Dr. Fouad Zaro

SCALE	1/100
Sheet Number	EL - 17
All Dimensions Are In Meters Unless Otherwise Shown. All Spot Levels Are In Meters.	
DATE: 2021/ 2022	

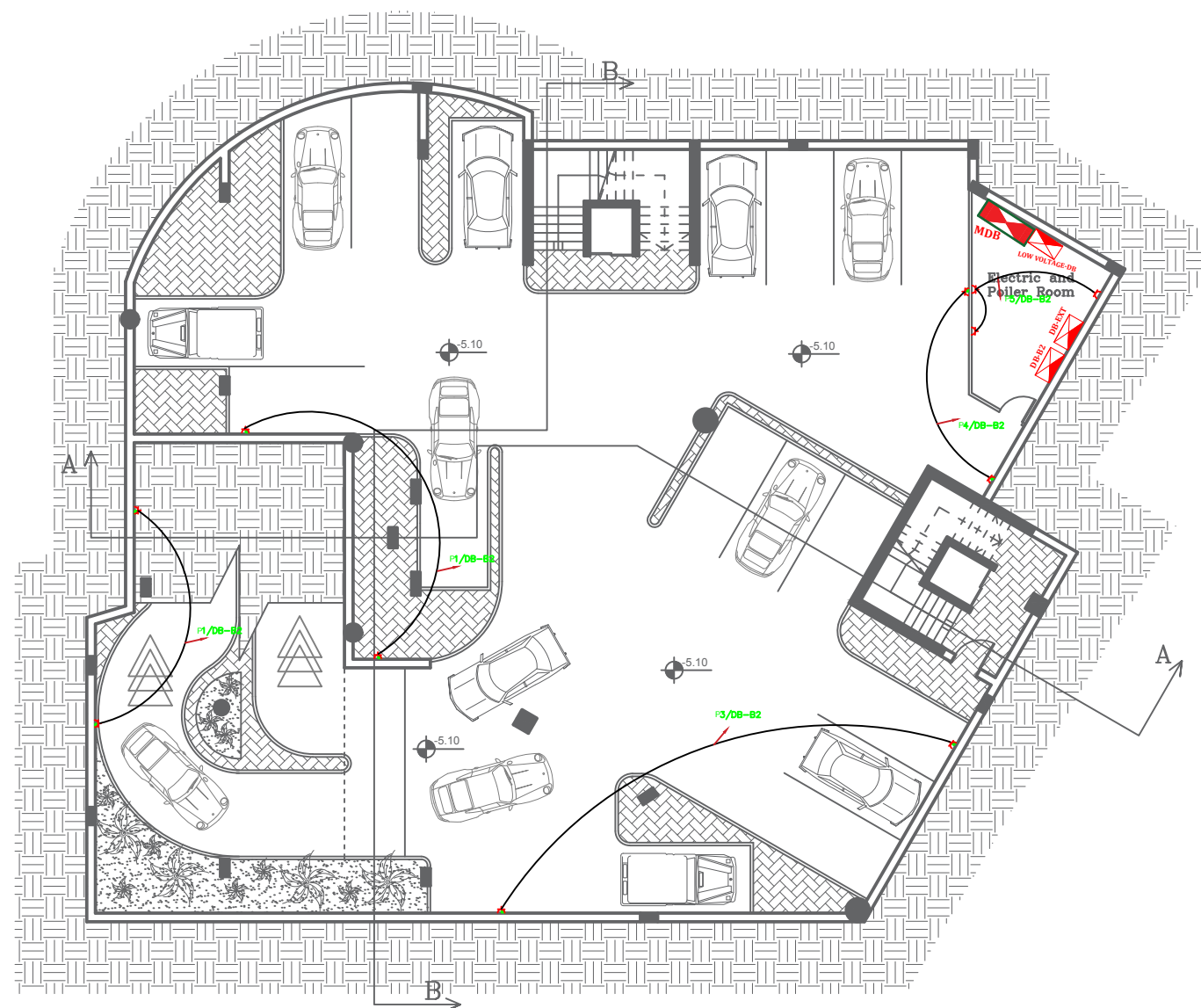

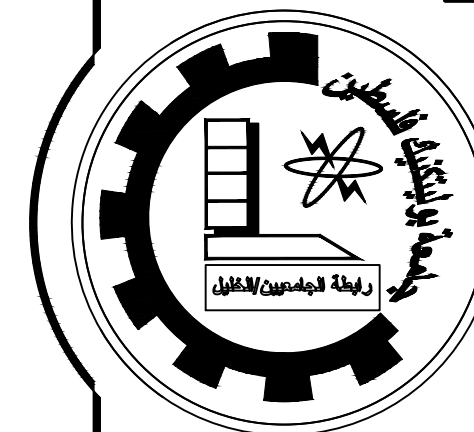

Palestine Polytechnic University
 College of Engineering
 Electrical Department
 Graduation Project

Project name :
 Electrical System, Lighting and
 Supporting Works Design for
 Commercial Mall in Hebron

Drawing Title :
 POWER-ground floor



Students Desinger:
 Marwa Abu Monefi
 Israa Hasanat
 Hind Saafin

Supervisor :
 Dr. Fouad Zaro

SCALE	1/100
Sheet Number	EL - 18
All Dimensions Are In Meters Unless Otherwise Shown. All Spot Levels Are In Meters.	
DATE: 2021/ 2022	

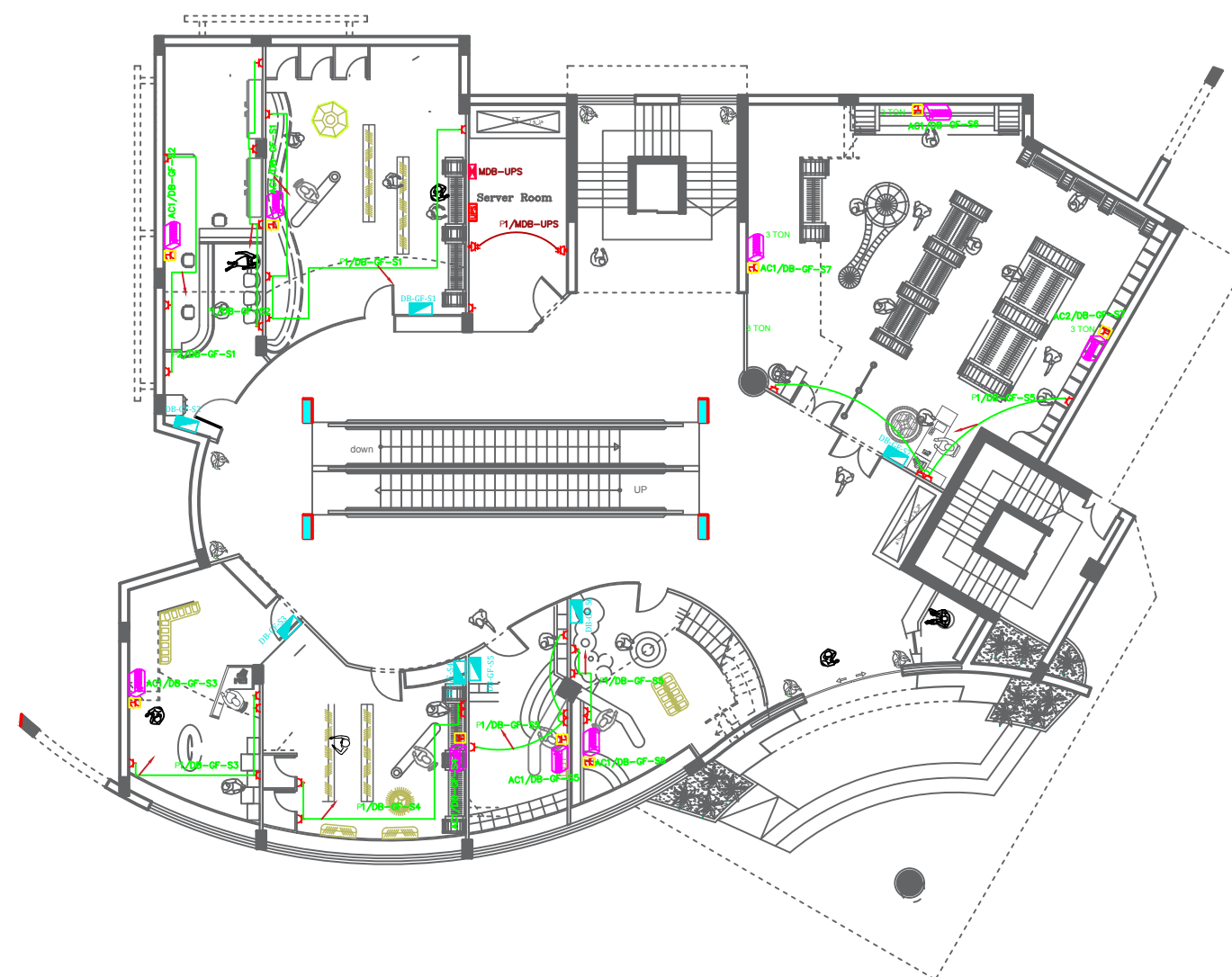

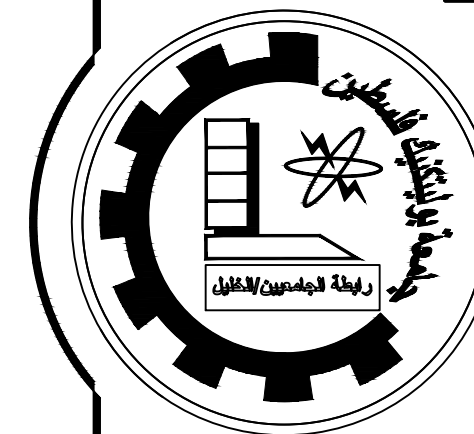

Palestine Polytechnic University
 College of Engineering
 Electrical Department
 Graduation Project

Project name :
 Electrical System, Lighting and
 Supporting Works Design for
 Commercial Mall in Hebron

Drawing Title :
 POWER-first floor



Students Desinger:
 Marwa Abu Monefi
 Israa Hasanat
 Hind Saafin

Supervisor :
 Dr. Fouad Zaro

SCALE	1/100
Sheet Number	EL - 19
All Dimensions Are In Meters Unless Otherwise Shown. All Spot Levels Are In Meters.	
DATE: 2021/ 2022	

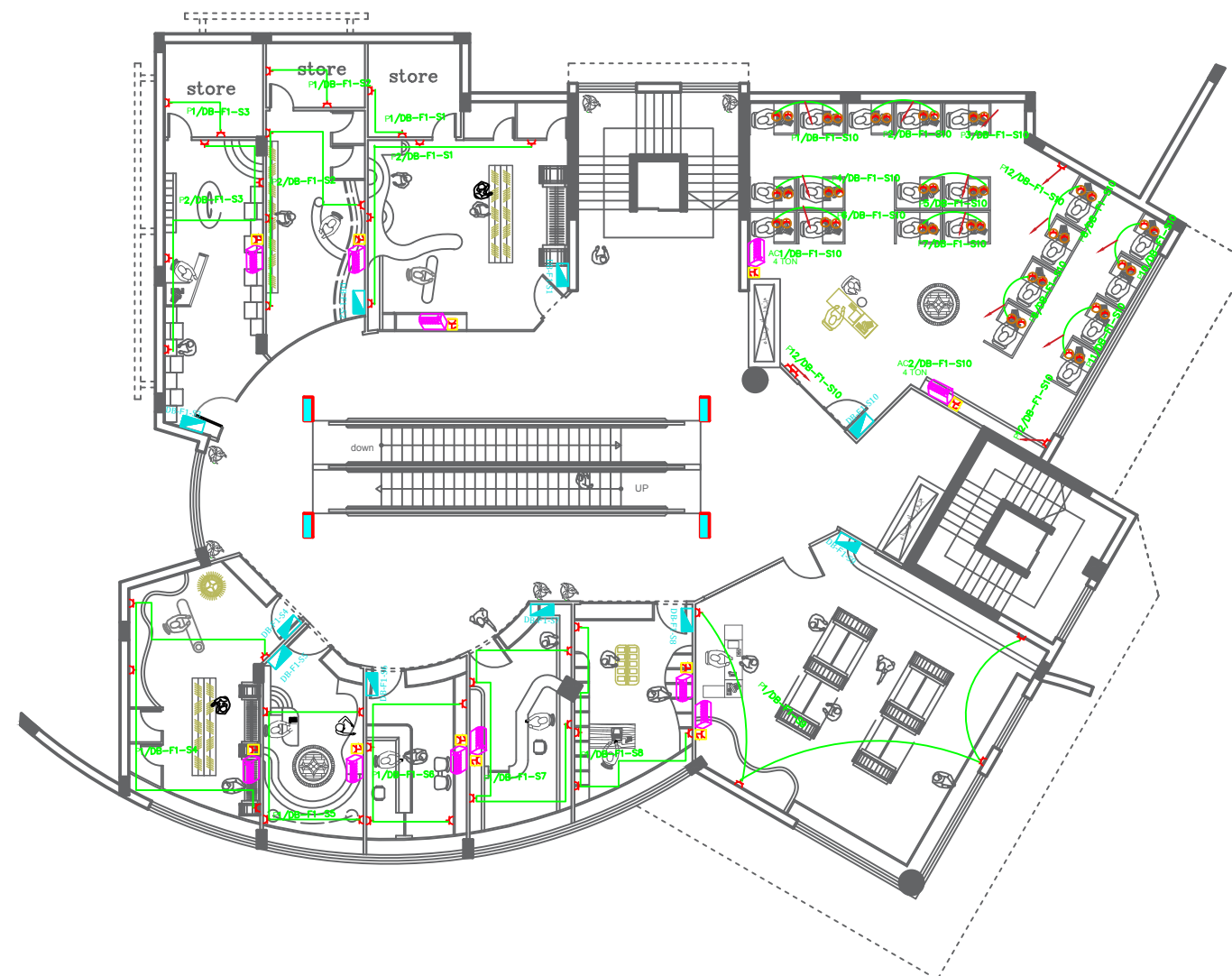

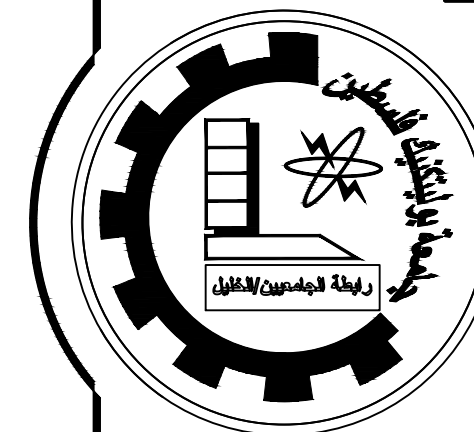

Palestine Polytechnic University
 College of Engineering
 Electrical Department
 Graduation Project

Project name :
 Electrical System, Lighting and
 Supporting Works Design for
 Commercial Mall in Hebron

Drawing Title :
 POWER-second floor

Students Desinger:
 Marwa Abu Monefi
 Israa Hasanat
 Hind Saafin

Supervisor :
 Dr. Fouad Zaro

SCALE	1/100
Sheet Number	EL - 20
All Dimensions Are In Meters Unless Otherwise Shown. All Spot Levels Are In Meters.	
DATE: 2021/ 2022	

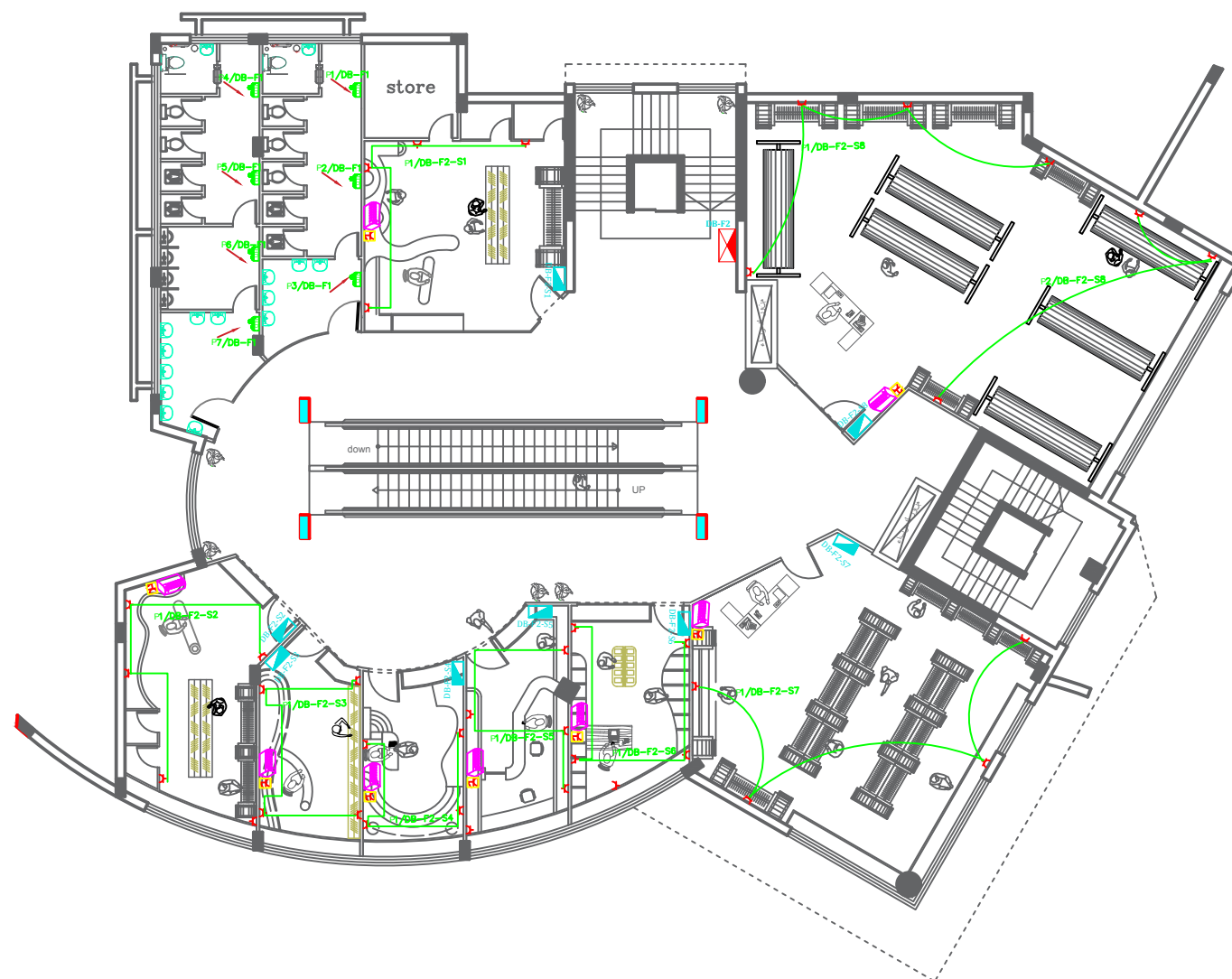

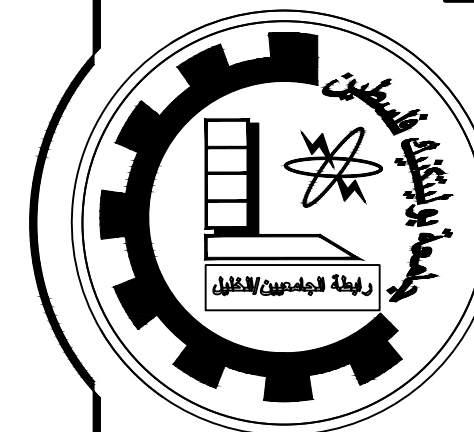

Palestine Polytechnic University
 College of Engineering
 Electrical Department
 Graduation Project

Project name :
 Electrical System, Lighting and
 Supporting Works Design for
 Commercial Mall in Hebron

Drawing Title :
 POWER-third floor



Students Desinger:
 Marwa Abu Monefi
 Israa Hasanat
 Hind Saafin

Supervisor :
 Dr. Fouad Zaro

SCALE	1/100
Sheet Number	EL - 21
All Dimensions Are In Meters Unless Otherwise Shown. All Spot Levels Are In Meters.	
DATE: 2021/ 2022	

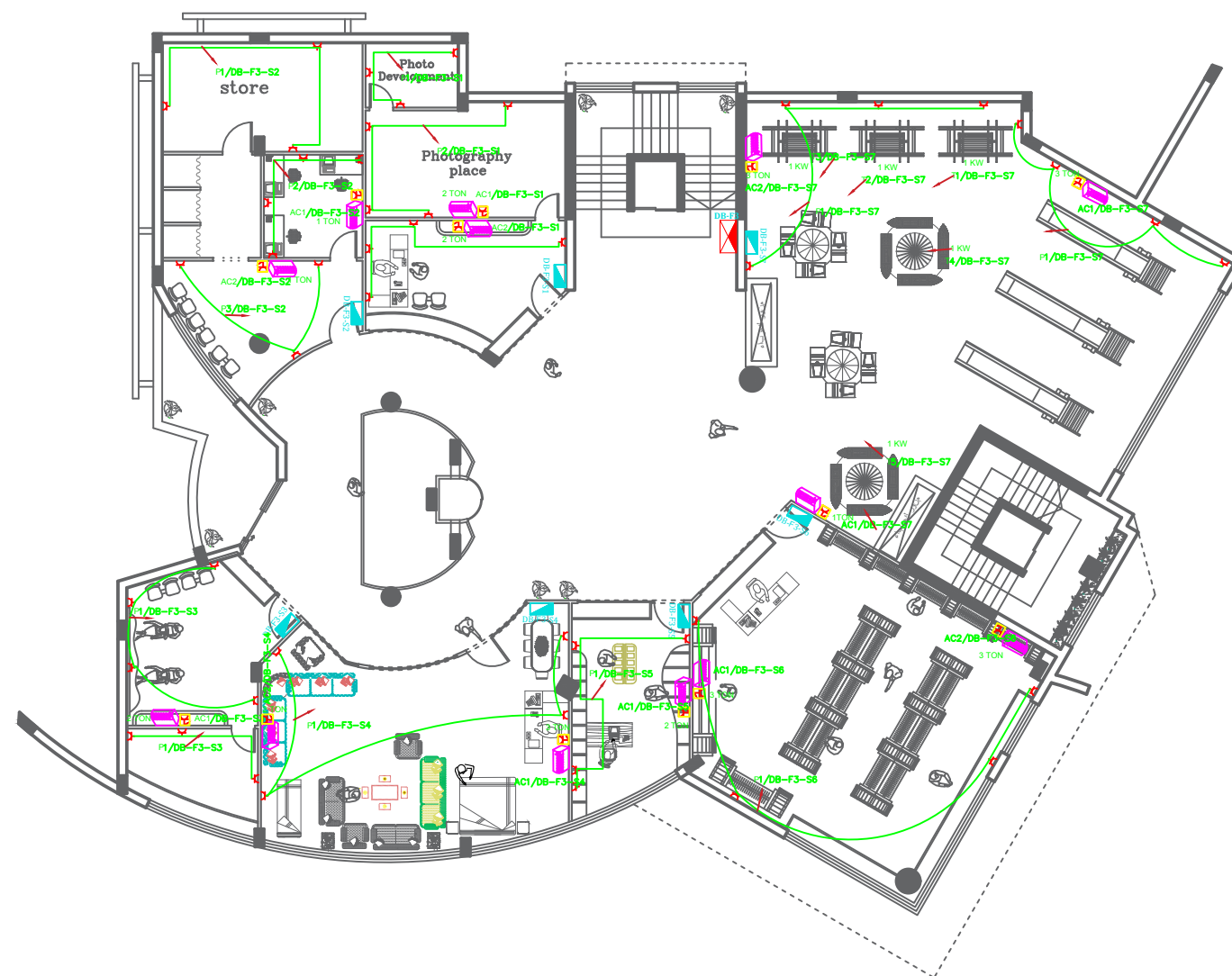

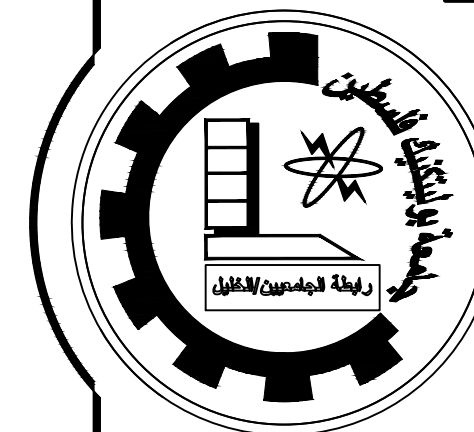

Palestine Polytechnic University
 College of Engineering
 Electrical Department
 Graduation Project

Project name :
 Electrical System, Lighting and
 Supporting Works Design for
 Commercial Mall in Hebron

Drawing Title :
 POWER-fourth floor

Students Desinger:
 Marwa Abu Monefi
 Israa Hasanat
 Hind Saafin

Supervisor :
 Dr. Fouad Zaro

SCALE	1/100
Sheet Number	EL - 22
All Dimensions Are In Meters Unless Otherwise Shown. All Spot Levels Are In Meters.	
DATE: 2021/ 2022	

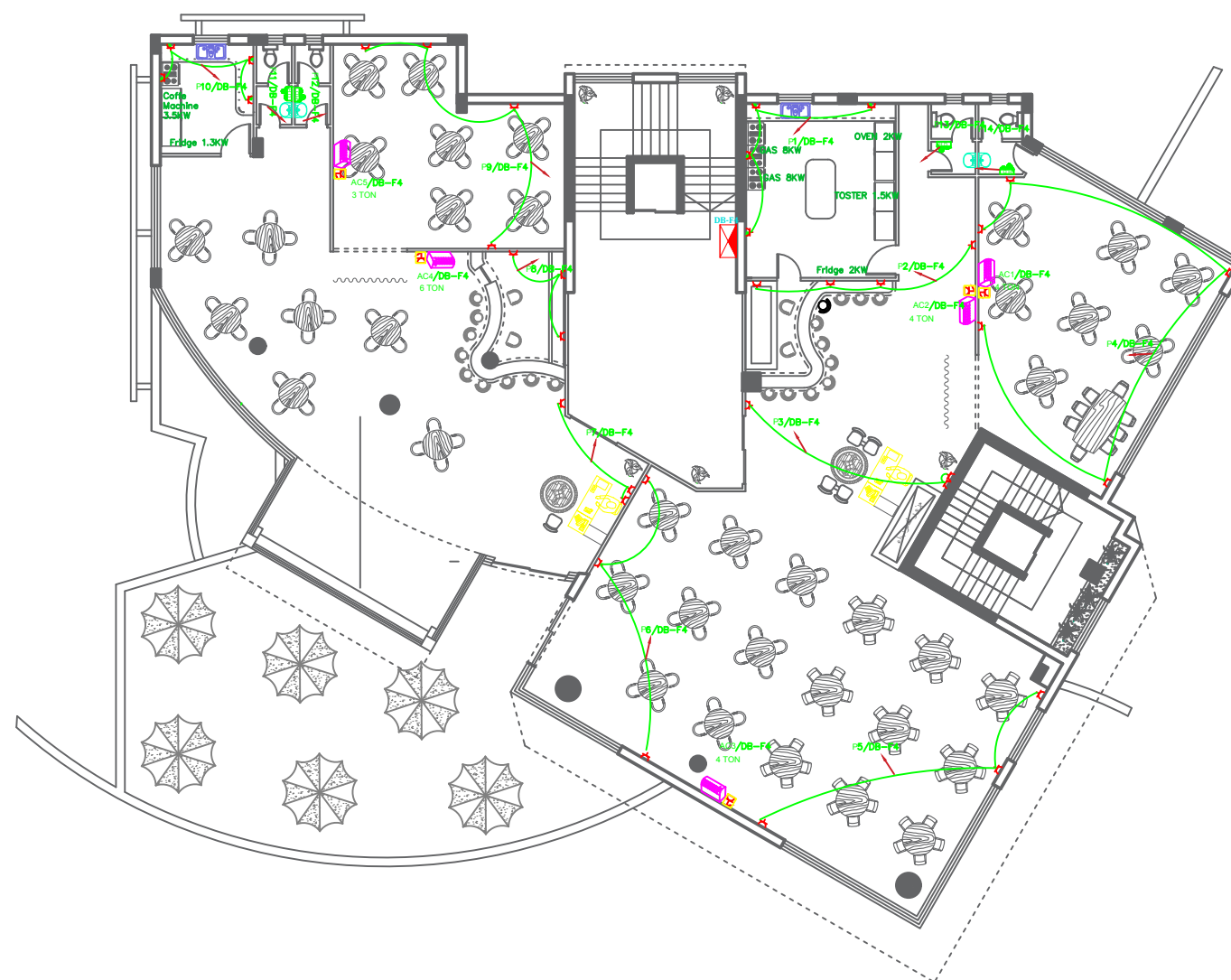

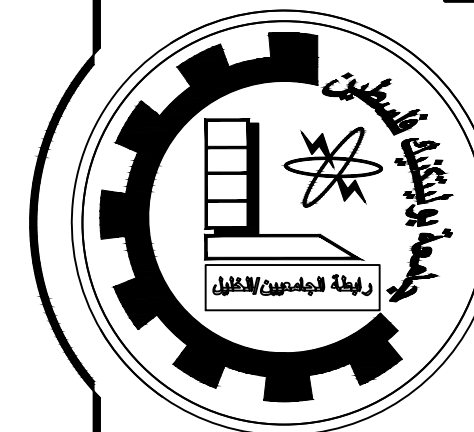

Palestine Polytechnic University
 College of Engineering
 Electrical Department
 Graduation Project

Project name :
 Electrical System, Lighting and
 Supporting Works Design for
 Commercial Mall in Hebron

Drawing Title :
 POWER-fifth floor

Students Desinger:
 Marwa Abu Monefi
 Israa Hasanat
 Hind Saafin

Supervisor :
 Dr. Fouad Zaro

SCALE	1/100
Sheet Number	EL - 23
All Dimensions Are In Meters Unless Otherwise Shown.	
All Spot Levels Are In Meters.	
DATE: 2021/ 2022	



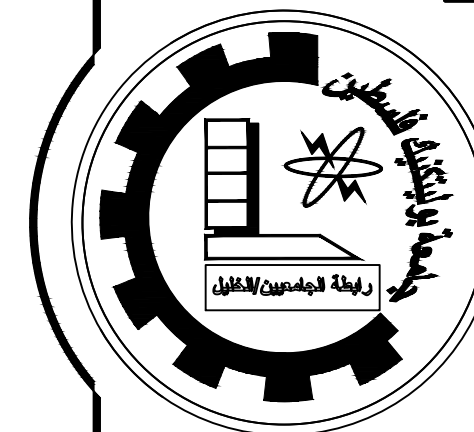

Palestine Polytechnic University
College of Engineering
Electrical Department
Graduation Project

Project name :
Electrical System, Lighting and
Supporting Works Design for
Commercial Mall in Hebron

Drawing Title :
POWER-sixth floor

Students Desinger:
Marwa Abu Monefi
Israa Hasanat
Hind Saafin

Supervisor :
Dr. Fouad Zaro

SCALE	1/100
Sheet Number	EL - 24
All Dimensions Are In Meters Unless Otherwise Shown. All Spot Levels Are In Meters.	
DATE: 2021/ 2022	

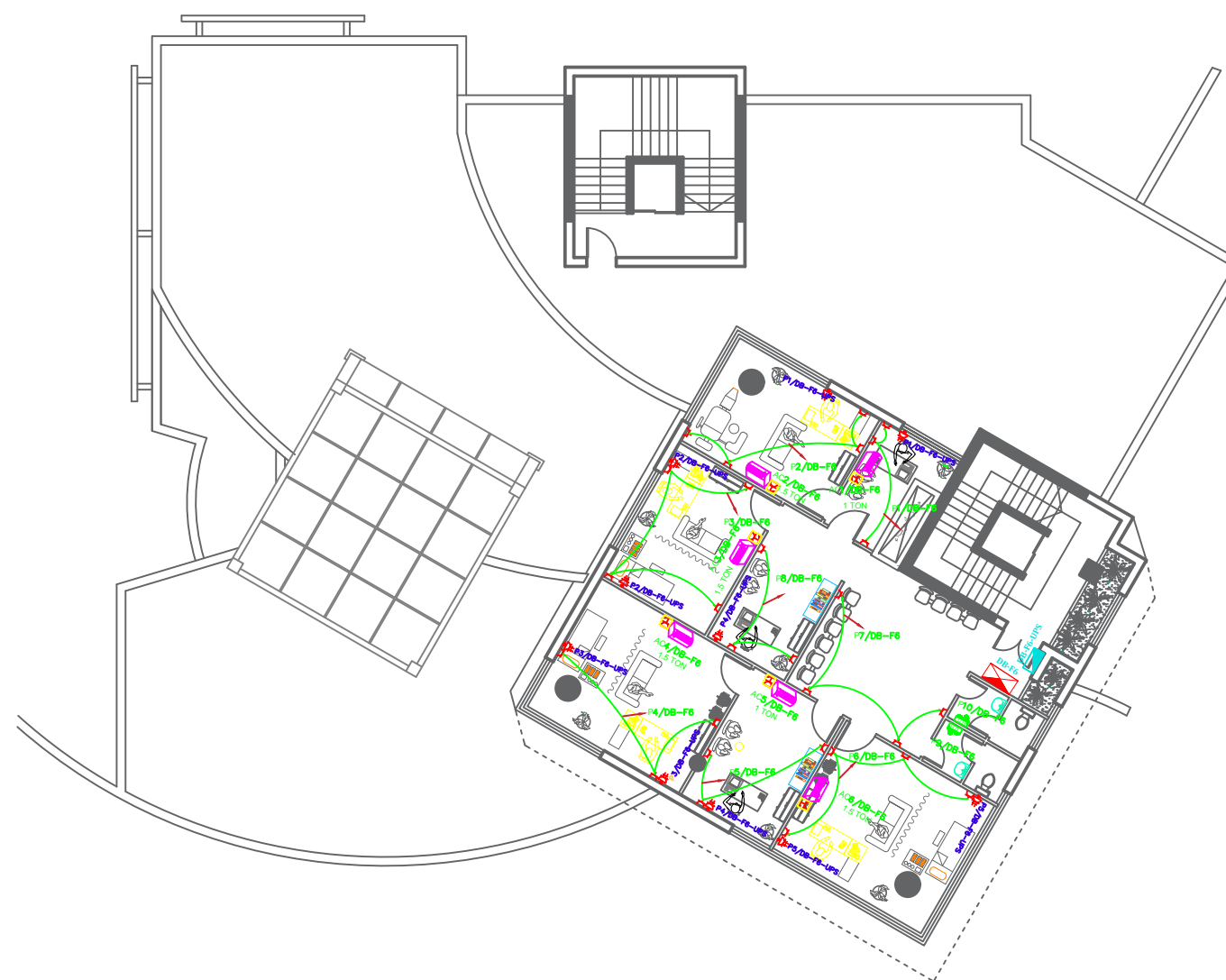

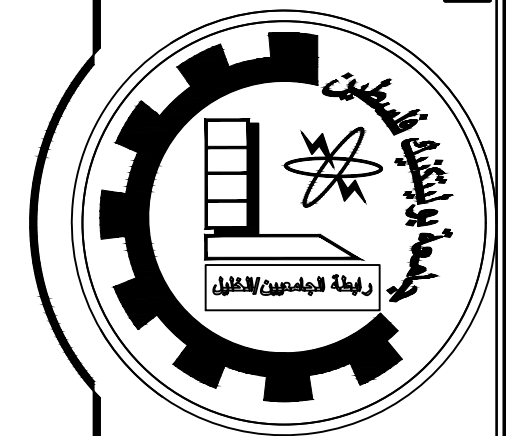
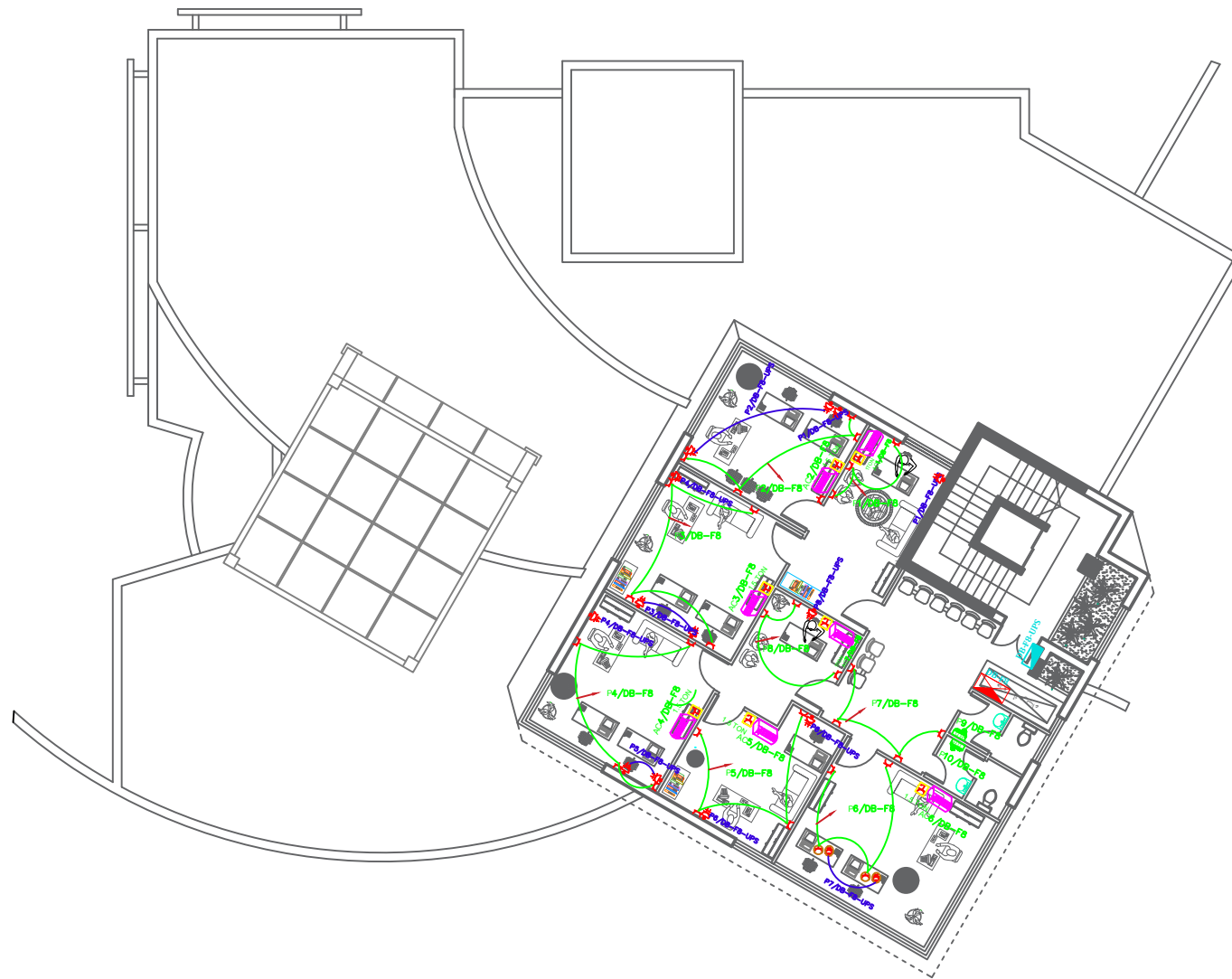

Palestine Polytechnic University
 College of Engineering
 Electrical Department
 Graduation Project

Project name :
 Electrical System, Lighting and
 Supporting Works Design for
 Commercial Mall in Hebron

Drawing Title :
 POWER-eighth floor

Students Desinger:
 Marwa Abu Monefi
 Israa Hasanat
 Hind Saafin

Supervisor :
 Dr. Fouad Zaro

SCALE	1/100
Sheet Number	EL - 26
All Dimensions Are In Meters Unless Otherwise Shown. All Spot Levels Are In Meters.	
DATE: 2021/ 2022	

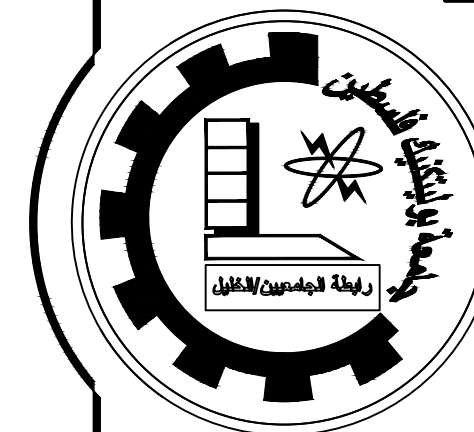

Palestine Polytechnic University
College of Engineering
Electrical Department
Graduation Project

Project name :
Electrical System, Lighting and
Supporting Works Design for
Commercial Mall in Hebron

Drawing Title :
POWER-ninth floor

Students Desinger:
Marwa Abu Monefi
Israa Hasanat
Hind Saafin

Supervisor :
Dr. Fouad Zaro

SCALE	1/100
Sheet Number	EL - 27
All Dimensions Are In Meters Unless Otherwise Shown. All Spot Levels Are In Meters.	
DATE: 2021/ 2022	

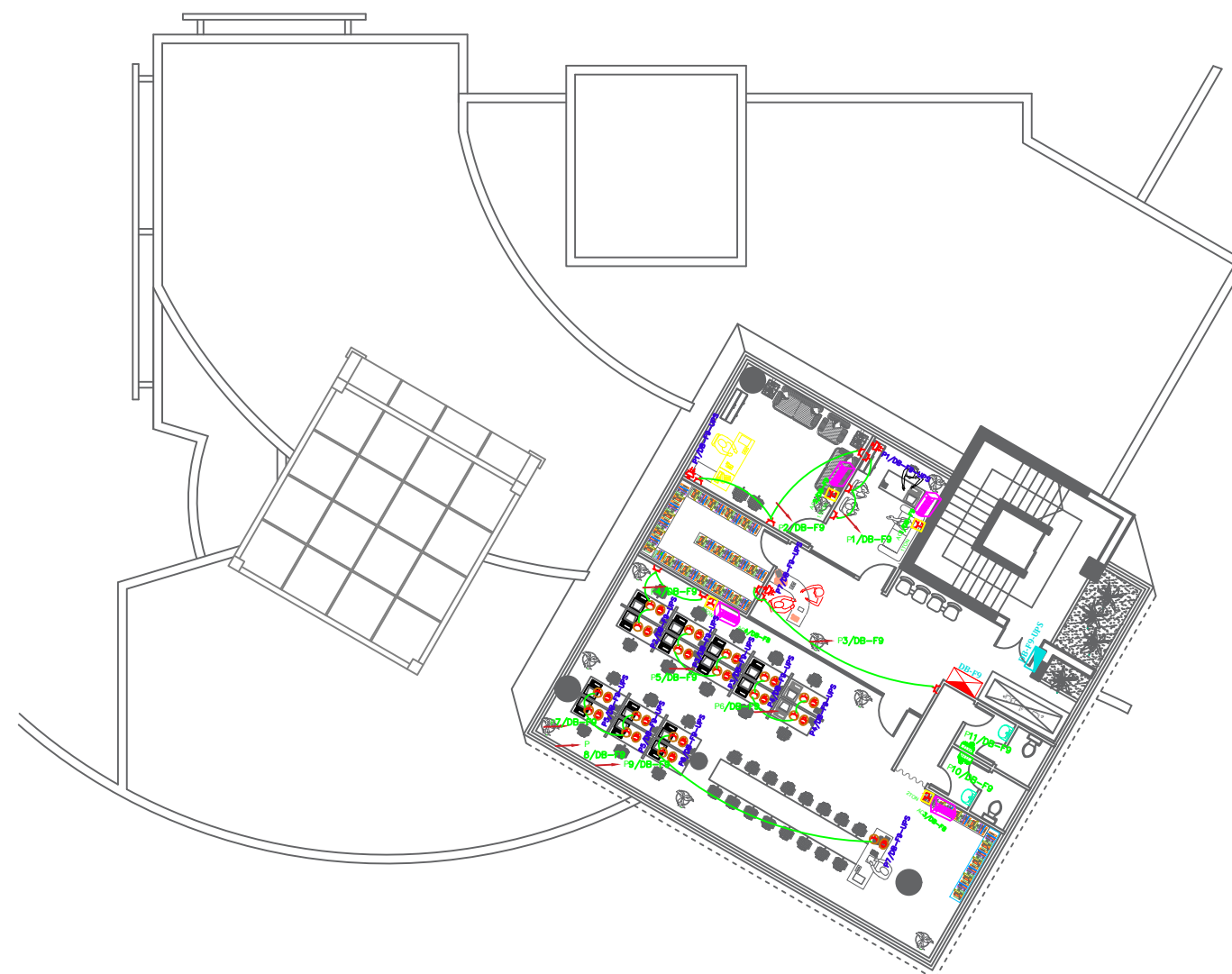

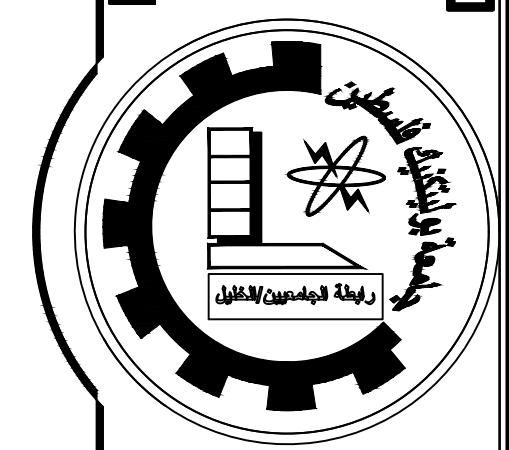

Palestine Polytechnic University
 College of Engineering
 Electrical Department
 Graduation Project

Project name :
 Electrical System, Lighting and
 Supporting Works Design for
 Commercial Mall in Hebron

Drawing Title :
 DB for floor

Students Desinger:
 Israa Hasanat
 Marwa abu Munief
 Hind Saafin

Supervisor :
 Dr. Fouad Zaro

SCALE	1/100
Sheet Number	EL-28
All Dimensions Are In Meters Unless Otherwise Shown.	
All Spot Levels Are In Meters.	
DATE: 2021/ 2022	

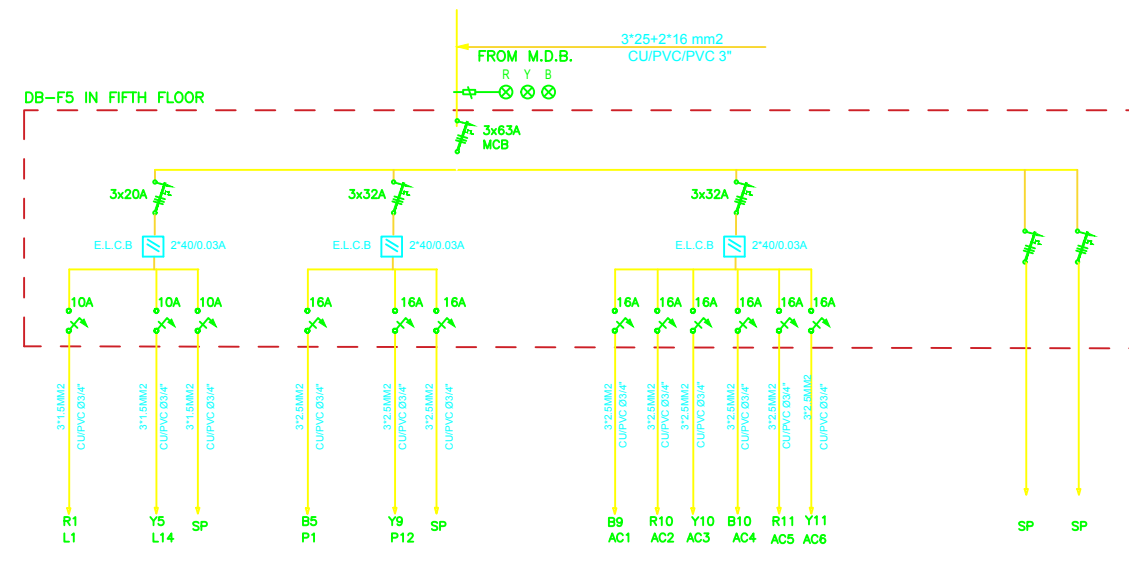
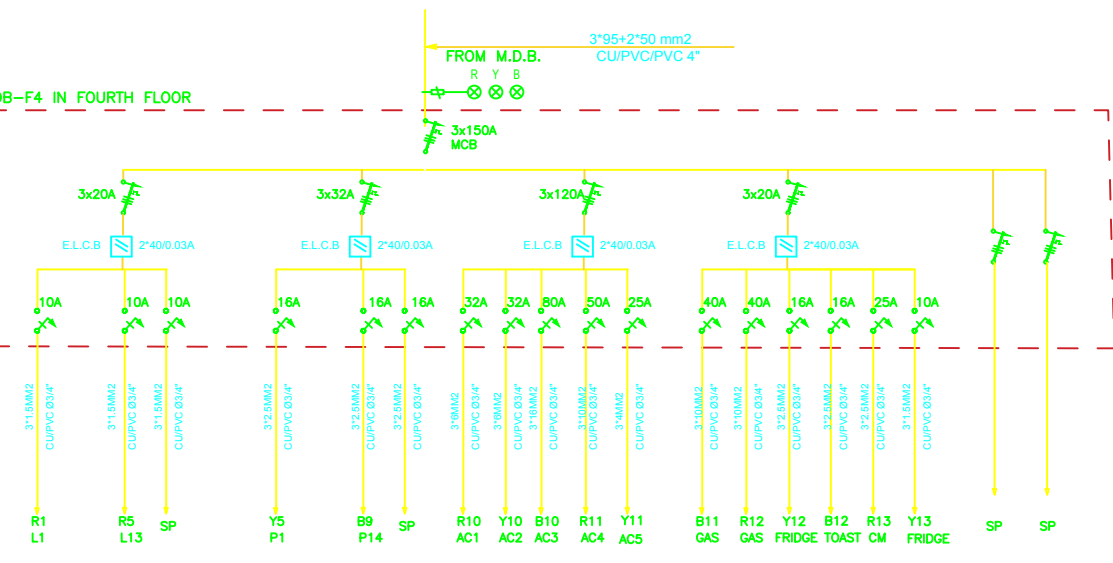
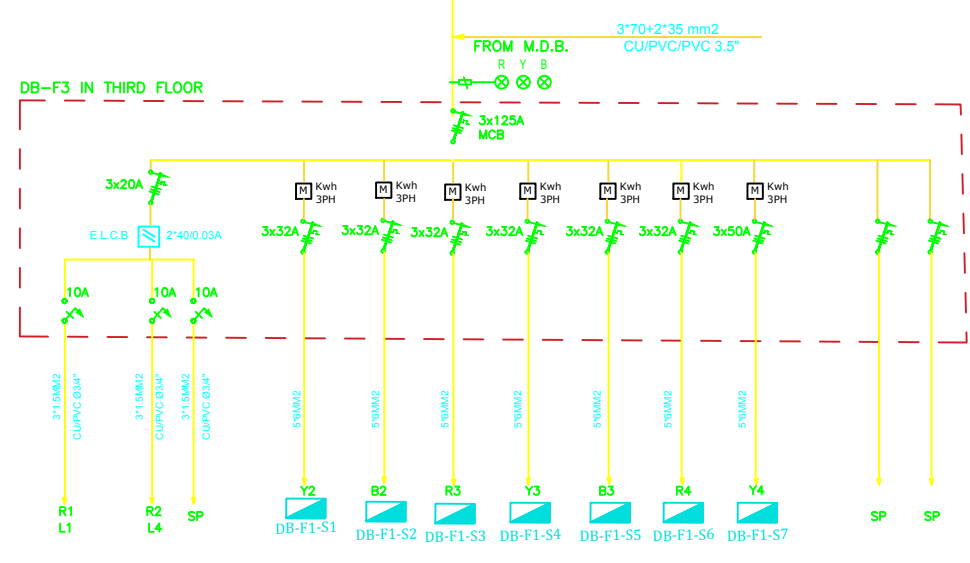
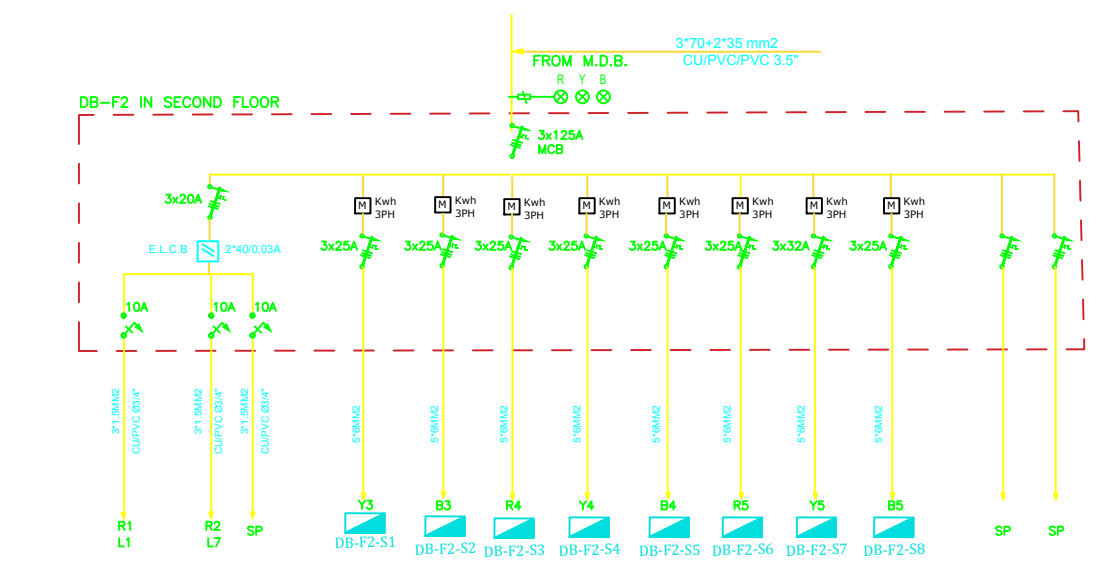
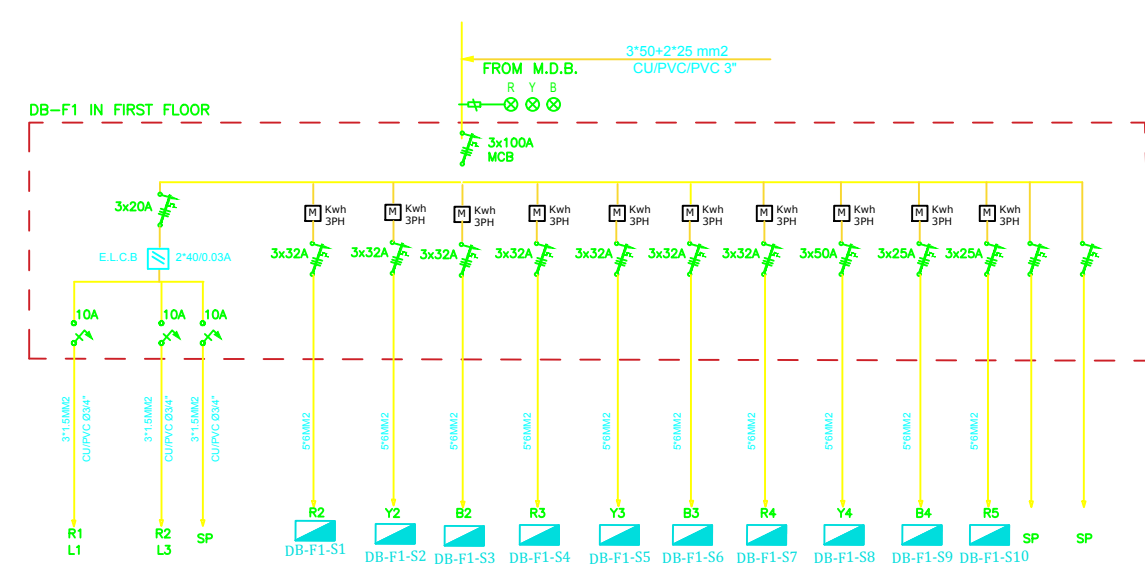
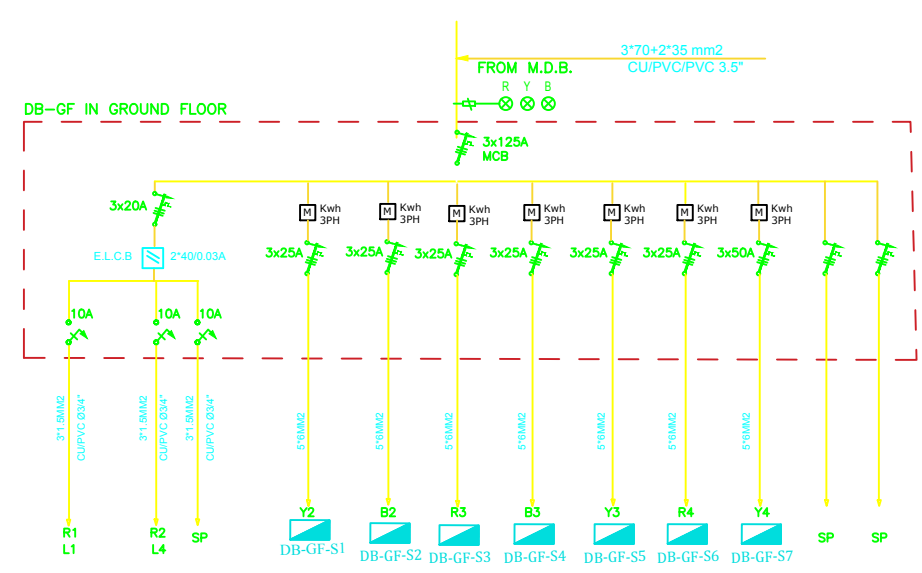

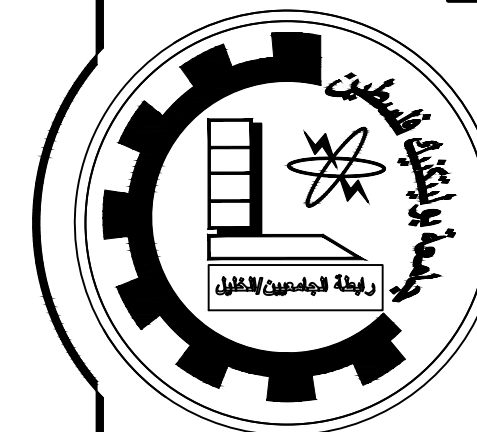

Palestine Polytechnic University
 College of Engineering
 Electrical Department
 Graduation Project

Project name :
 Electrical System, Lighting and
 Supporting Works Design for
 Commercial Mall in Hebron

Drawing Title :
 DB for floor

Students Desinger:
 Israa Hasanat
 Marwa abu Munief
 Hind Saafin

Supervisor :
 Dr. Fouad Zaro

SCALE	1/100
Sheet Number	EL-29
All Dimensions Are In Meters Unless Otherwise Shown. All Spot Levels Are In Meters.	
DATE: 2021/ 2022	

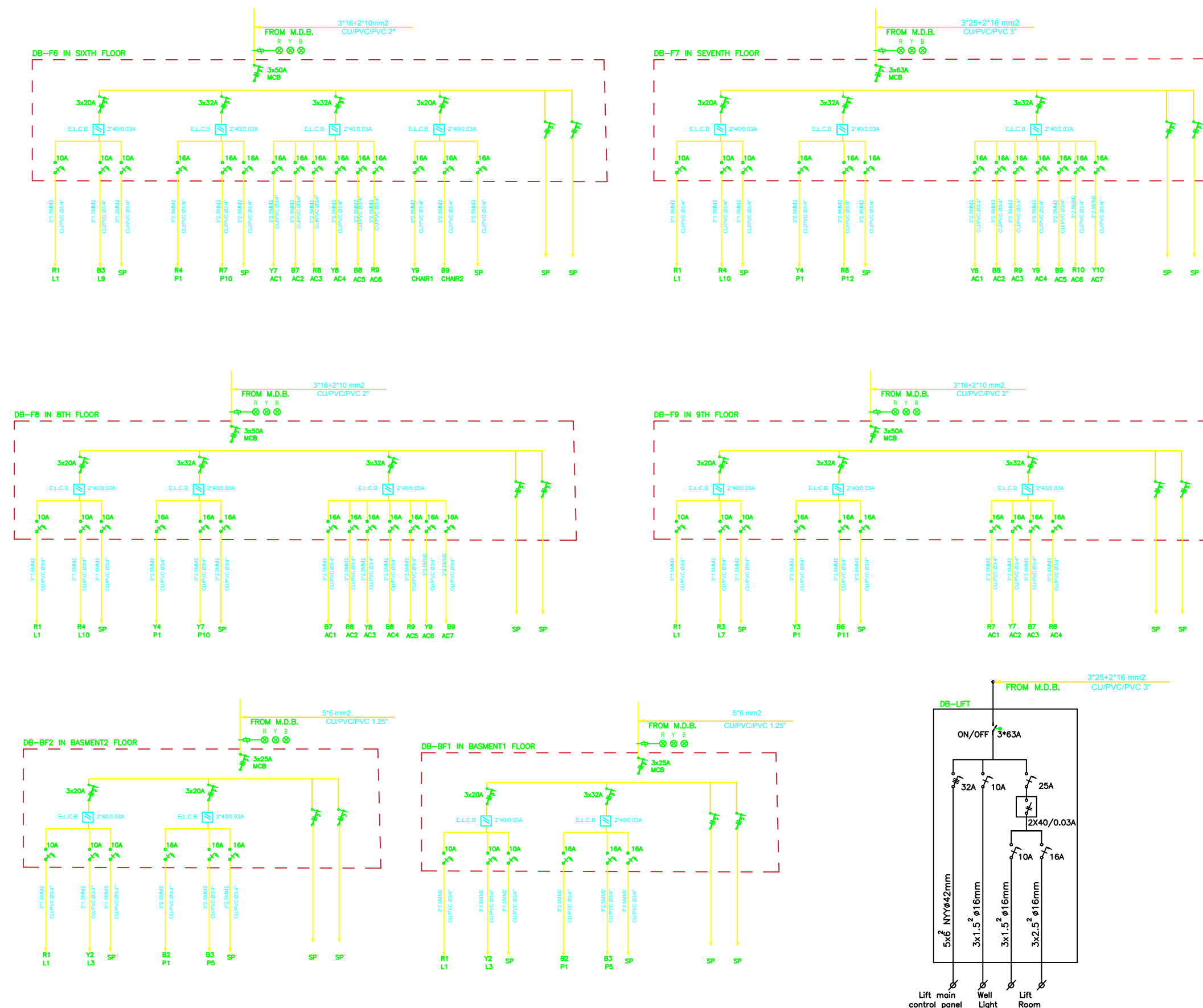

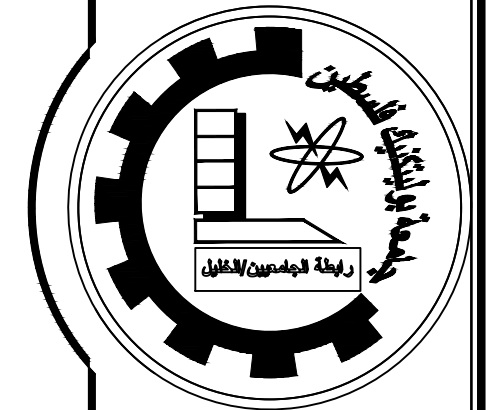

Palestine Polytechnic University
 College of Engineering
 Electrical Department
 Graduation Project

Project name :
 Electrical System, Lighting and
 Supporting Works Design for
 Commercial Mall in Hebron

Drawing Title :
 TE-00

Students Desinger:
 Israa Hasanat
 Marwa abu Muniefe
 Hind Saafin

Supervisor :
 Dr. Fouad Zaro

SCALE	1/100
Sheet Number	Basement2- Floor Plan
All Dimensions Are In Meters Unless Otherwise Shown. All Spot Levels Are In Meters.	
DATE: 2021/ 2022	

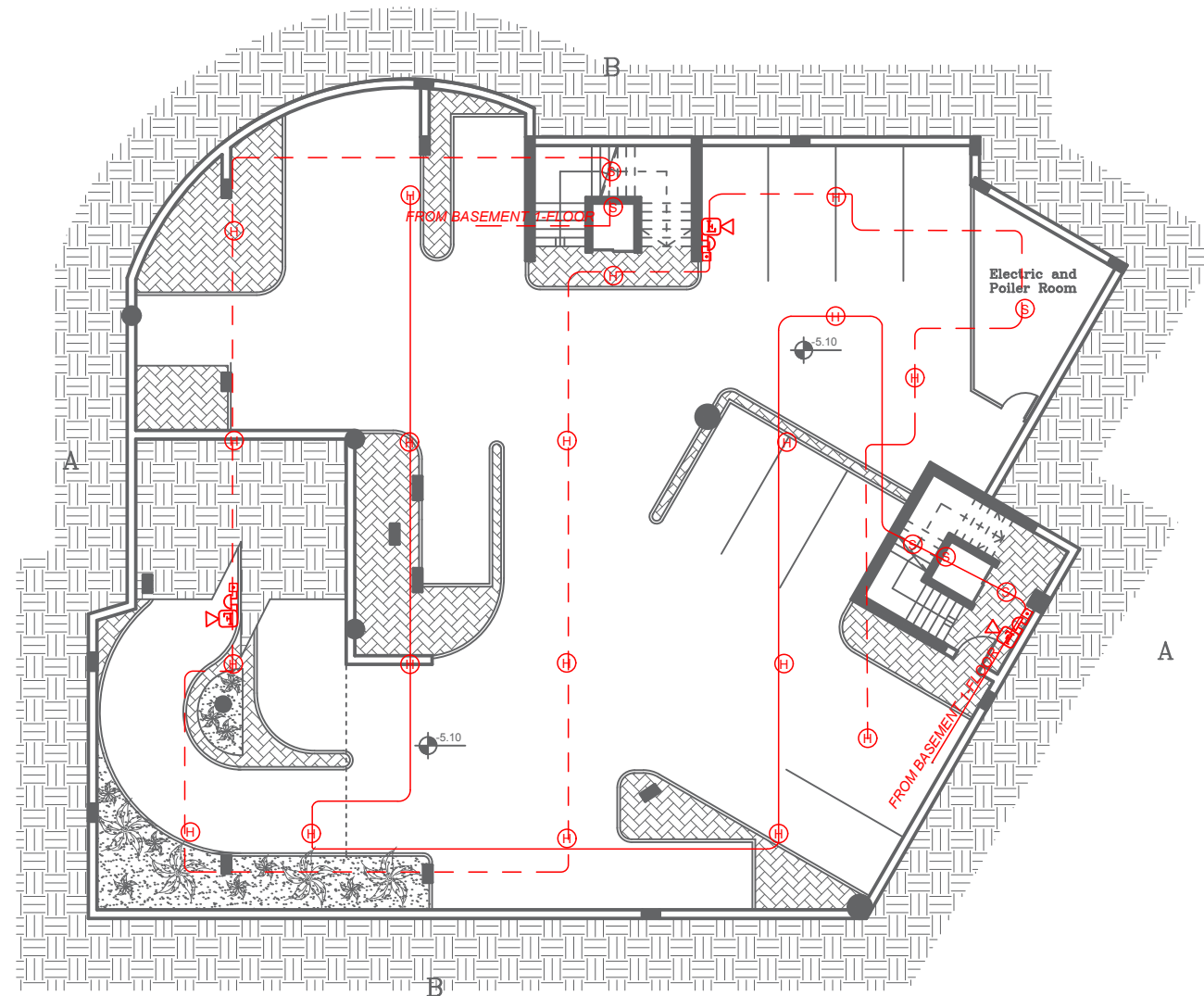

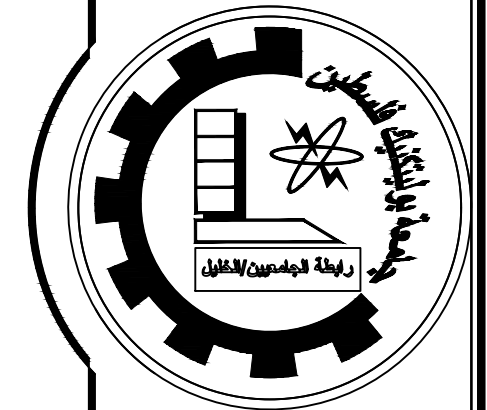

Palestine Polytechnic University
 College of Engineering
 Electrical Department
 Graduation Project

Project name :
 Electrical System, Lighting and
 Supporting Works Design for
 Commercial Mall in Hebron

Drawing Title :
 TE-01

Students Desinger:
 Israa Hasanat
 Marwa abu Muniefe
 Hind Saafin

Supervisor :
 Dr. Fouad Zaro

SCALE	1/100
Sheet Name	Basement1- Floor Plan
All Dimensions Are In Meters Unless Otherwise Shown. All Spot Levels Are In Meters.	
DATE: 2021/ 2022	

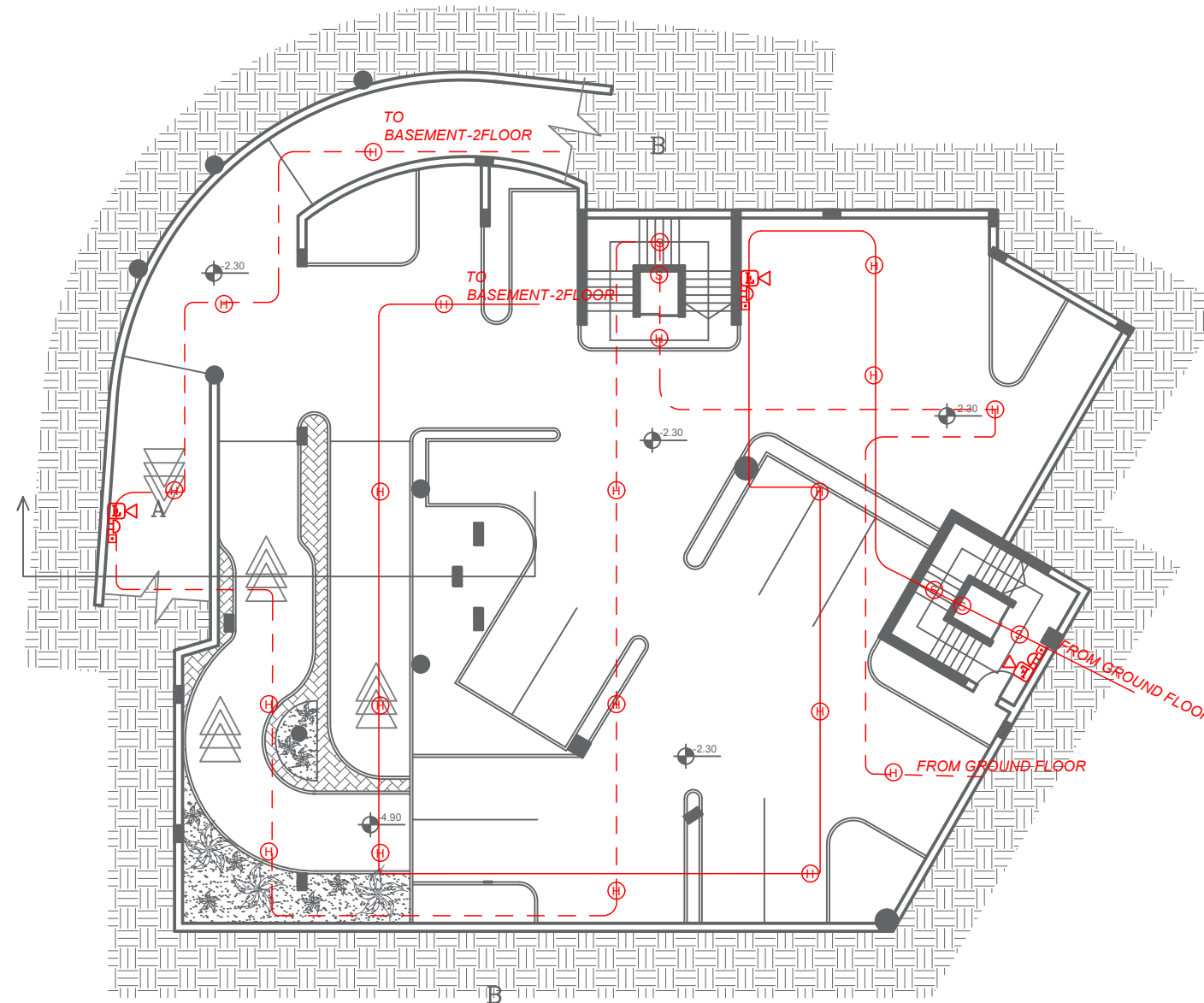

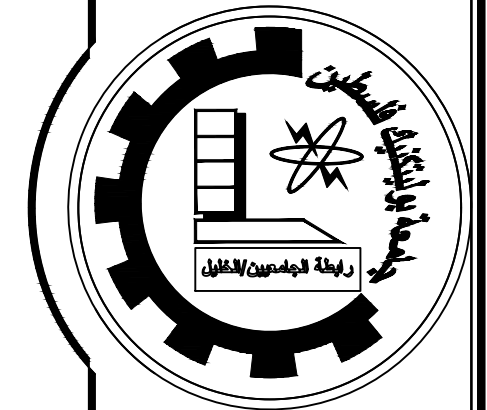

Palestine Polytechnic University
 College of Engineering
 Electrical Department
 Graduation Project

Project name :
 Electrical System, Lighting and
 Supporting Works Design for
 Commercial Mall in Hebron

Drawing Title :
 TE-02

Students Desinger:
 Israa Hasanat
 Marwa abu Muniefe
 Hind Saafin

Supervisor :
 Dr. Fouad Zaro

SCALE	1/100
Sheet Name	Ground Floor Plan
All Dimensions Are In Meters Unless Otherwise Shown. All Spot Levels Are In Meters.	
DATE: 2021/ 2022	

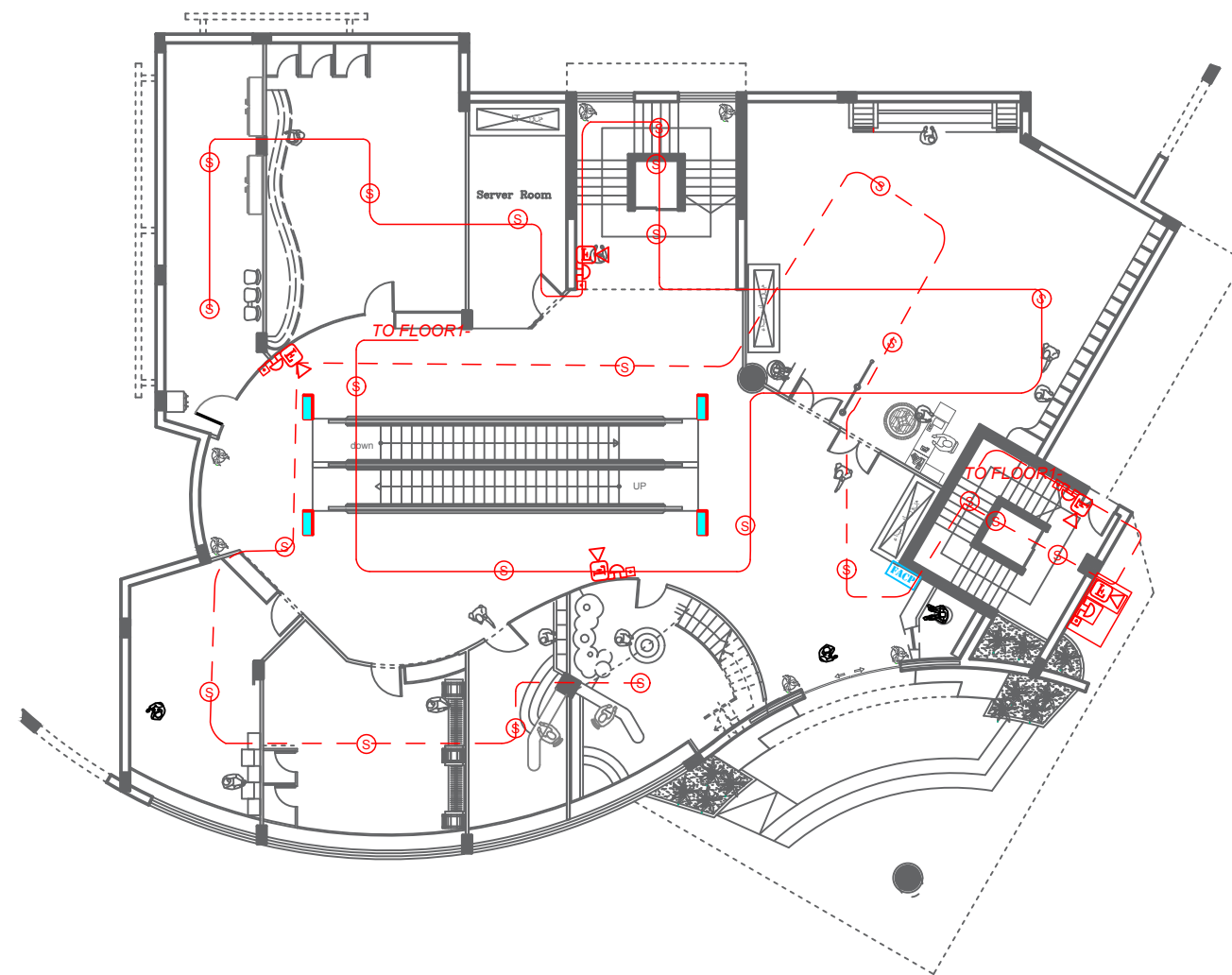

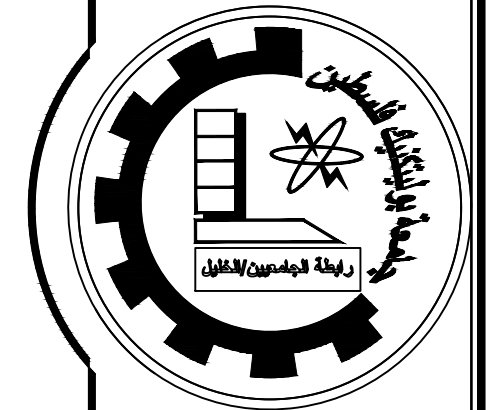
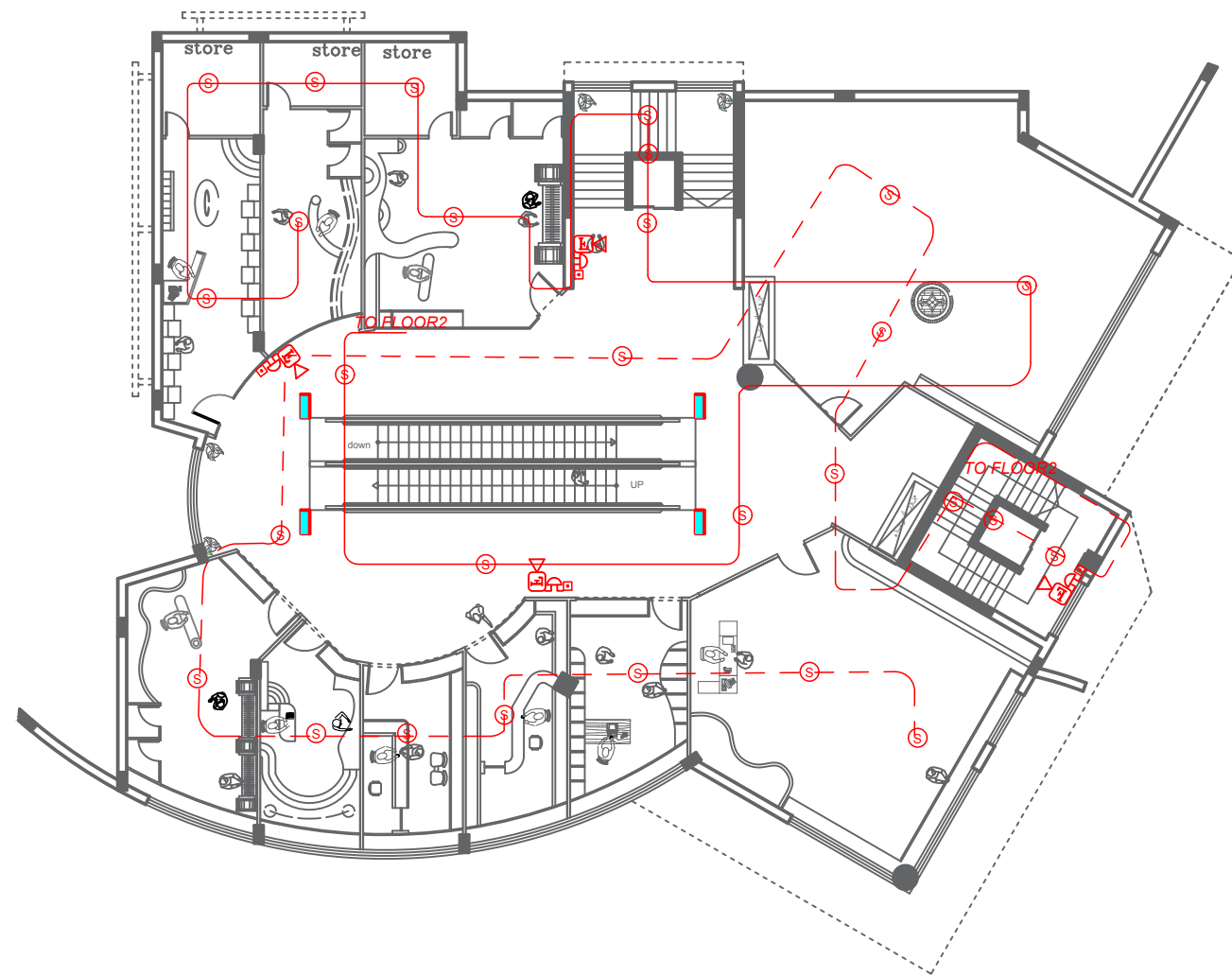

Palestine Polytechnic University
 College of Engineering
 Electrical Department
 Graduation Project

Project name :
 Electrical System, Lighting and
 Supporting Works Design for
 Commercial Mall in Hebron

Drawing Title :
 TE-03

Students Desinger:
 Israa Hasanat
 Marwa abu Muniefe
 Hind Saafin

Supervisor :
 Dr. Fouad Zaro

SCALE	1/100
Sheet Name	1 st - Floor Plan
All Dimensions Are In Meters Unless Otherwise Shown. All Spot Levels Are In Meters.	
DATE: 2021/ 2022	

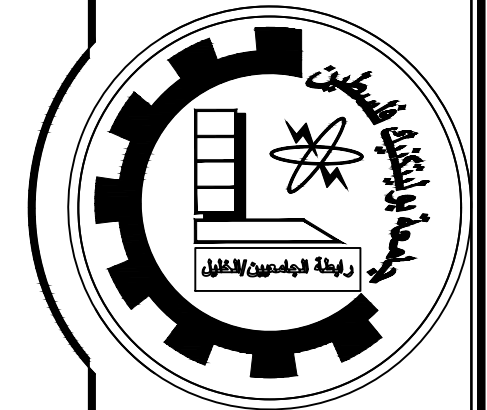

Palestine Polytechnic University
 College of Engineering
 Electrical Department
 Graduation Project

Project name :
 Electrical System, Lighting and
 Supporting Works Design for
 Commercial Mall in Hebron

Drawing Title :
 TE-04

Students Desinger:
 Israa Hasanat
 Marwa abu Muniefe
 Hind Saafin

Supervisor :
 Dr. Fouad Zaro

SCALE	1/100
Sheet Name	2 nd - Floor Plan
All Dimensions Are In Meters Unless Otherwise Shown. All Spot Levels Are In Meters.	
DATE: 2021/ 2022	

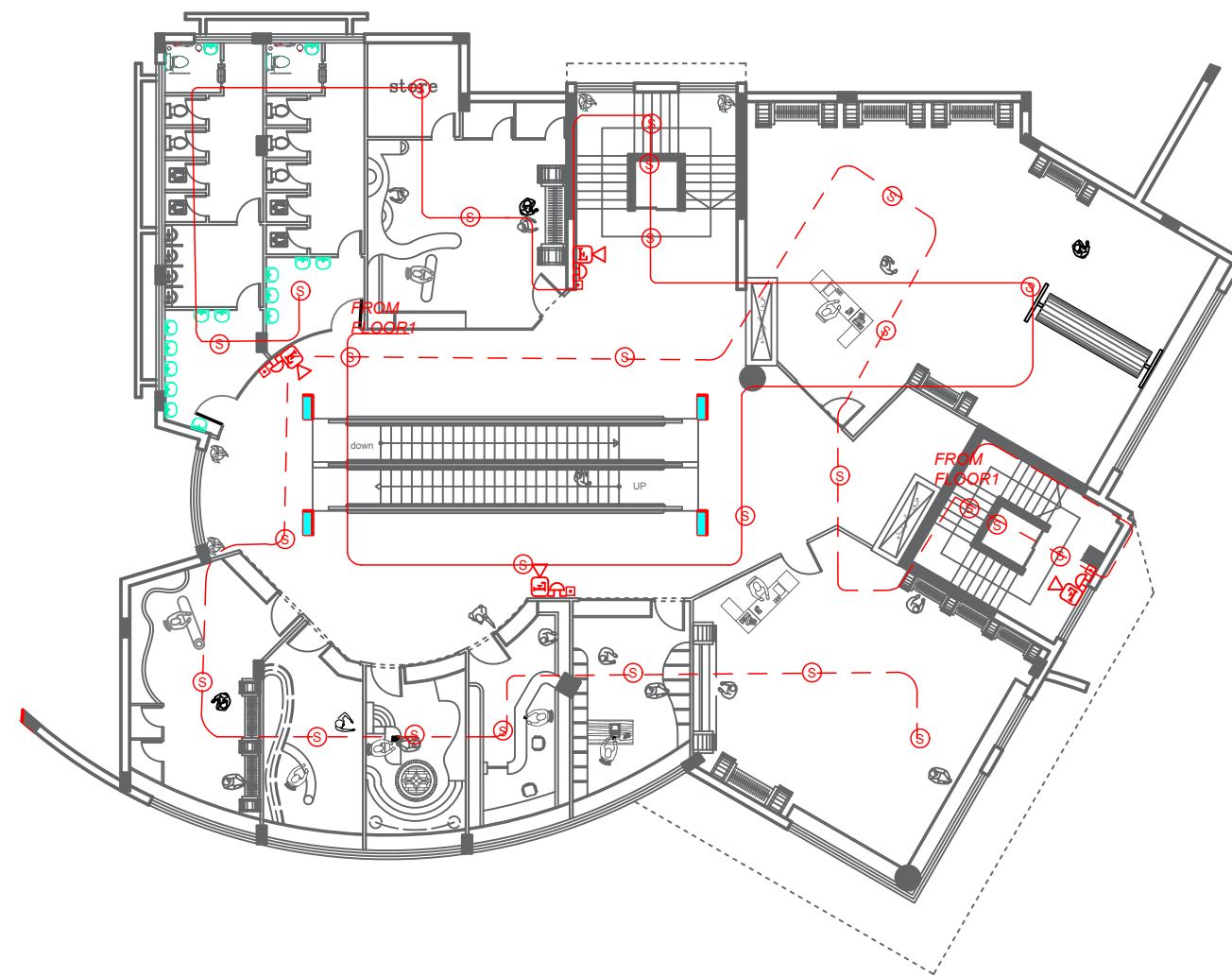

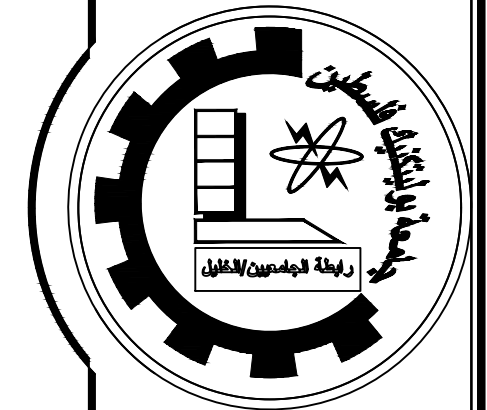
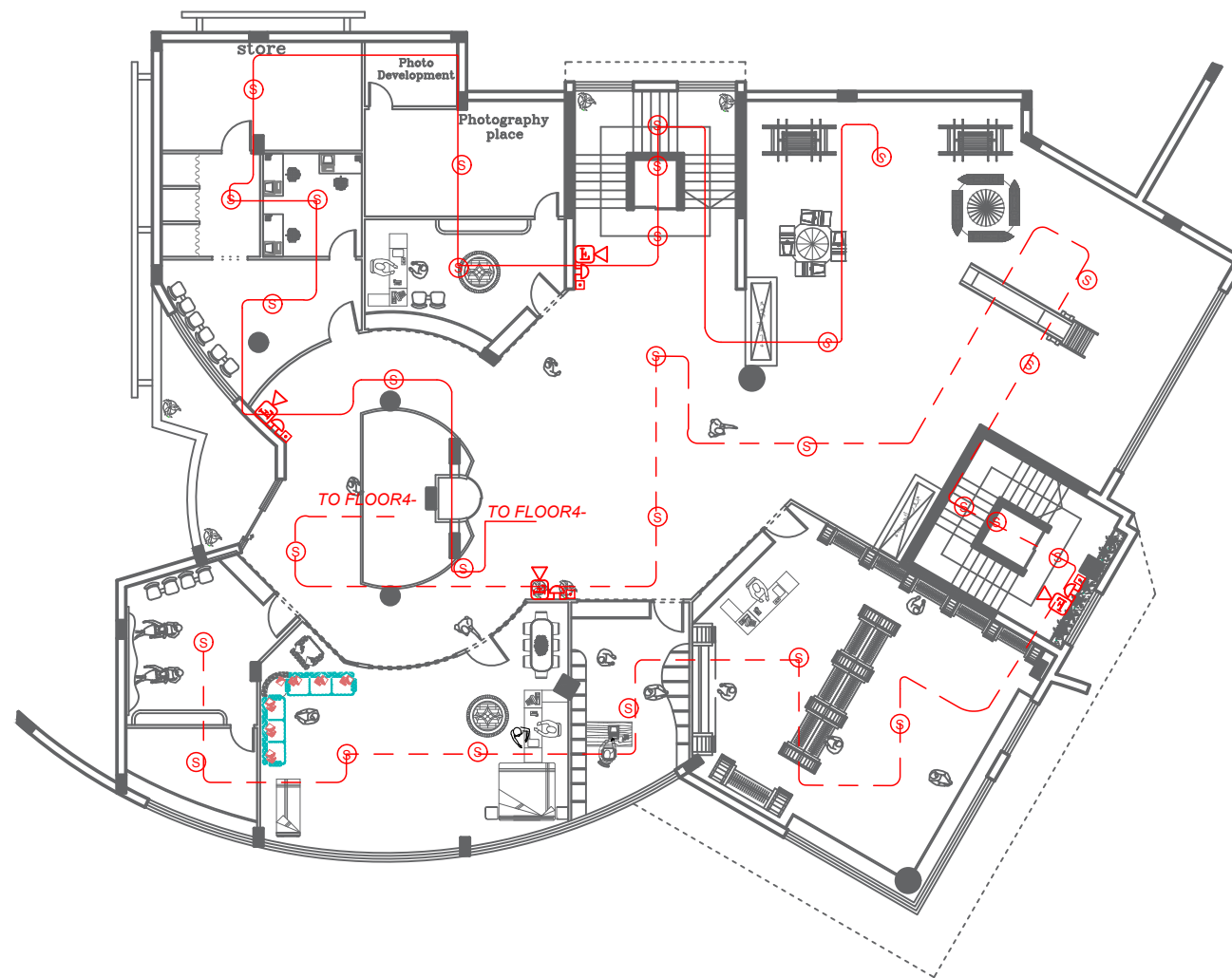

Palestine Polytechnic University
 College of Engineering
 Electrical Department
 Graduation Project

Project name :
 Electrical System, Lighting and
 Supporting Works Design for
 Commercial Mall in Hebron

Drawing Title :
 TE-05

Students Desinger:
 Israa Hasanat
 Marwa abu Muniefe
 Hind Saafin

Supervisor :
 Dr. Fouad Zaro

SCALE	1/100
Sheet Name	3 rd - Floor Plan
All Dimensions Are In Meters Unless Otherwise Shown. All Spot Levels Are In Meters.	
DATE: 2021/ 2022	

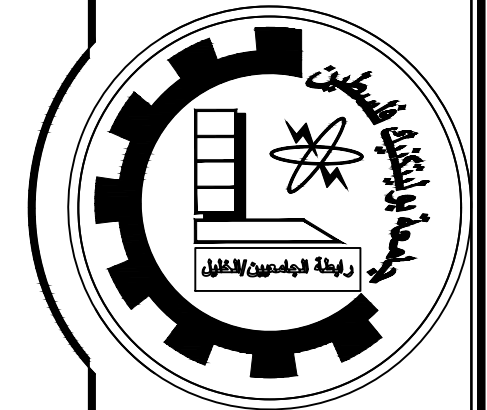

Palestine Polytechnic University
 College of Engineering
 Electrical Department
 Graduation Project

Project name :
 Electrical System, Lighting and
 Supporting Works Design for
 Commercial Mall in Hebron

Drawing Title :
 TE-06

Students Desinger:
 Israa Hasanat
 Marwa abu Muniefe
 Hind Saafin

Supervisor :
 Dr. Fouad Zaro

SCALE 1/100

Sheet Name 4th - Floor Plan

All Dimensions Are In Meters
 Unless Otherwise Shown.
 All Spot Levels Are In Meters.

DATE: 2021/ 2022

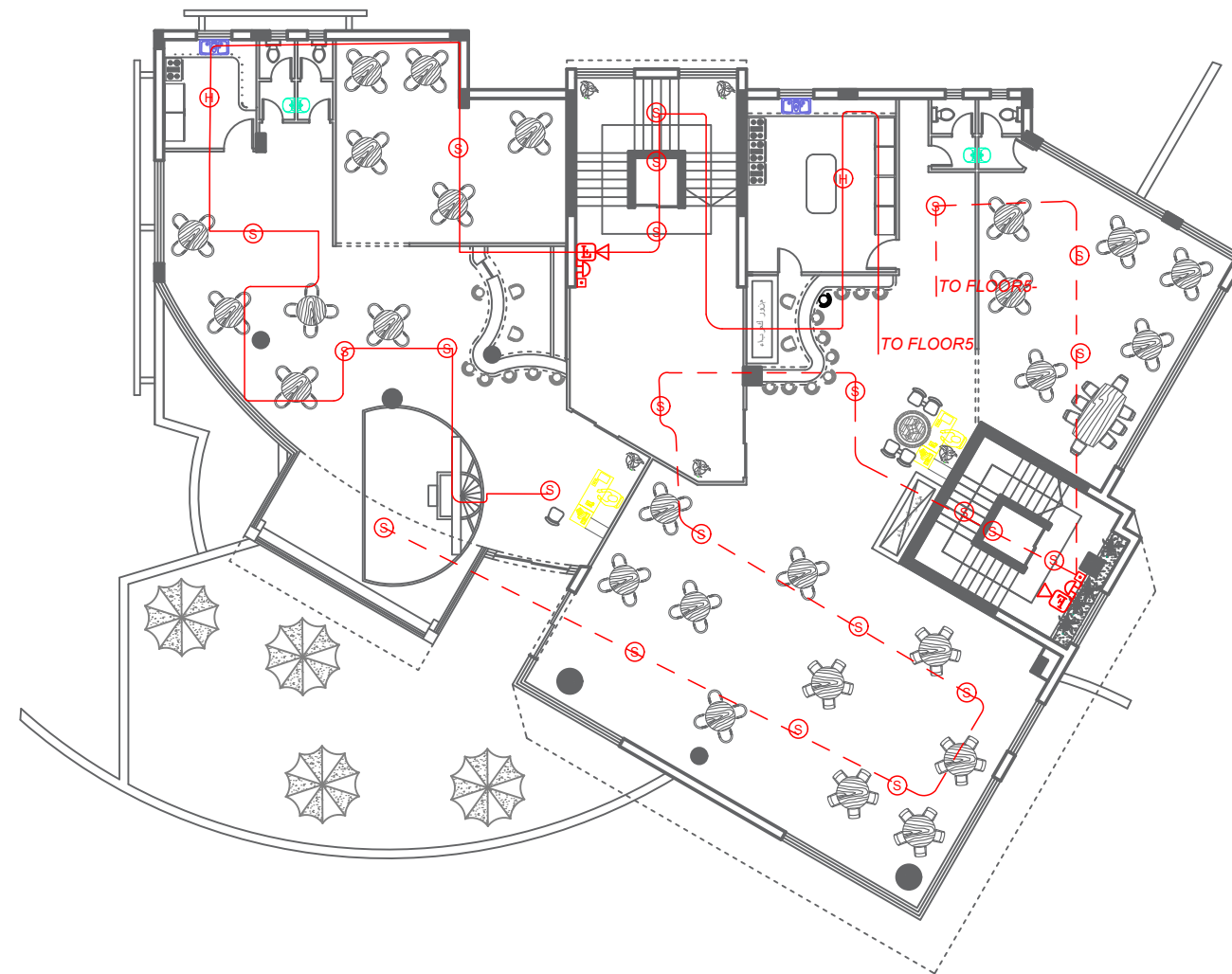

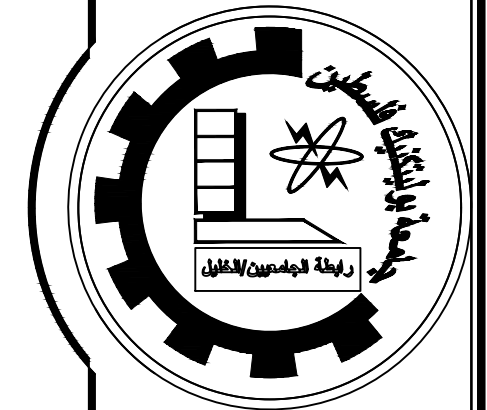

Palestine Polytechnic University
College of Engineering
Electrical Department
Graduation Project

Project name :

Electrical System, Lighting and
Supporting Works Design for
Commercial Mall in Hebron

Drawing Title :

TE-07

Students Desinger:

Israa Hasanat
Marwa abu Muniefe
Hind Saafin

Supervisor :

Dr. Fouad Zaro

SCALE 1/100

Sheet Name 5th - Floor Plan

All Dimensions Are In Meters
Unless Otherwise Shown.
All Spot Levels Are In Meters.

DATE: 2021/ 2022



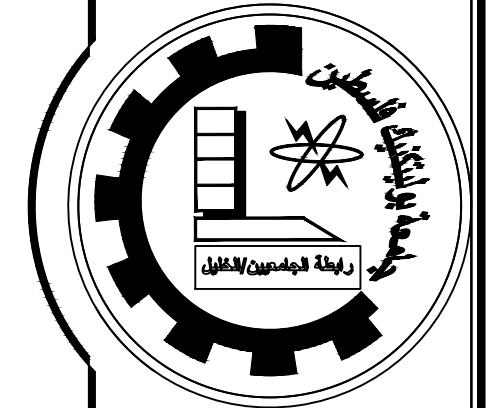
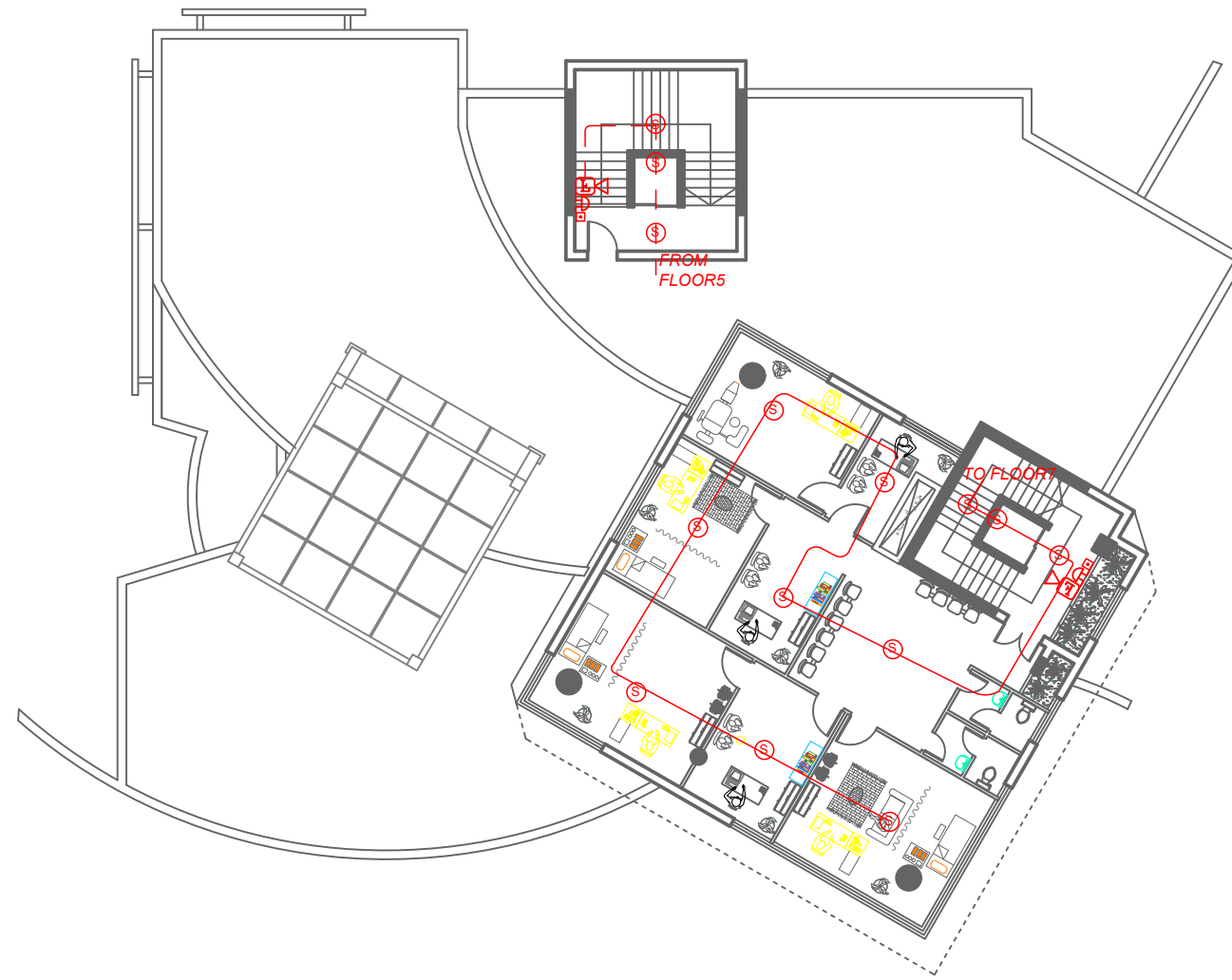

Palestine Polytechnic University
 College of Engineering
 Electrical Department
 Graduation Project

Project name :
 Electrical System, Lighting and
 Supporting Works Design for
 Commercial Mall in Hebron

Drawing Title :
 TE-08

Students Desinger:
 Israa Hasanat
 Marwa abu Muniefe
 Hind Saafin

Supervisor :
 Dr. Fouad Zaro

SCALE	1/100
Sheet Name	6 th - Floor Plan
All Dimensions Are In Meters Unless Otherwise Shown. All Spot Levels Are In Meters.	
DATE: 2021/ 2022	

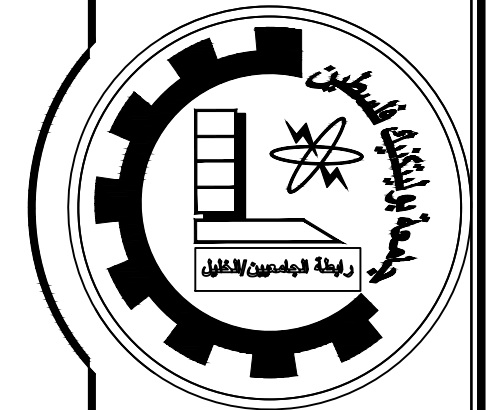

Palestine Polytechnic University
 College of Engineering
 Electrical Department
 Graduation Project

Project name :
 Electrical System, Lighting and
 Supporting Works Design for
 Commercial Mall in Hebron

Drawing Title :
 TE-09

Students Desinger:
 Israa Hasanat
 Marwa abu Muniefe
 Hind Saafin

Supervisor :
 Dr. Fouad Zaro

SCALE	1/100
Sheet Name	7 th - Floor Plan
All Dimensions Are In Meters Unless Otherwise Shown. All Spot Levels Are In Meters.	
DATE: 2021/ 2022	

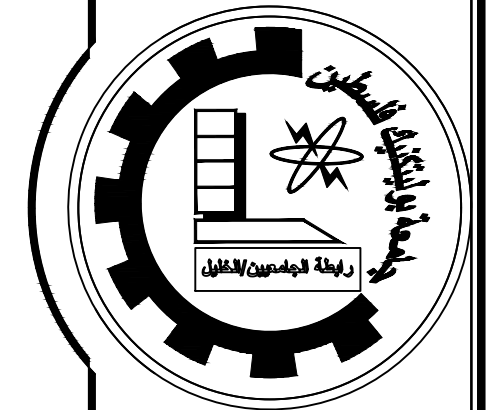

Palestine Polytechnic University
 College of Engineering
 Electrical Department
 Graduation Project

Project name :
 Electrical System, Lighting and
 Supporting Works Design for
 Commercial Mall in Hebron

Drawing Title :
 TE-10

Students Desinger:
 Israa Hasanat
 Marwa abu Muniefe
 Hind Saafin

Supervisor :
 Dr. Fouad Zaro

SCALE	1/100
Sheet Name	8 th - Floor Plan
All Dimensions Are In Meters Unless Otherwise Shown. All Spot Levels Are In Meters.	
DATE: 2021/ 2022	

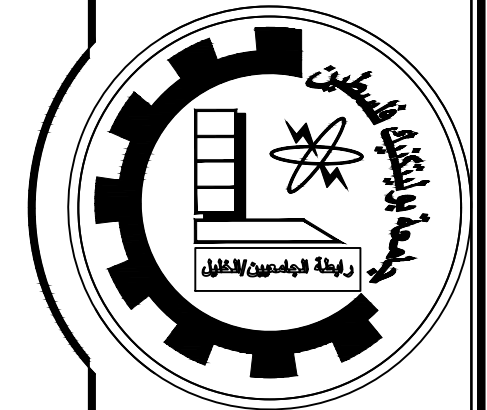
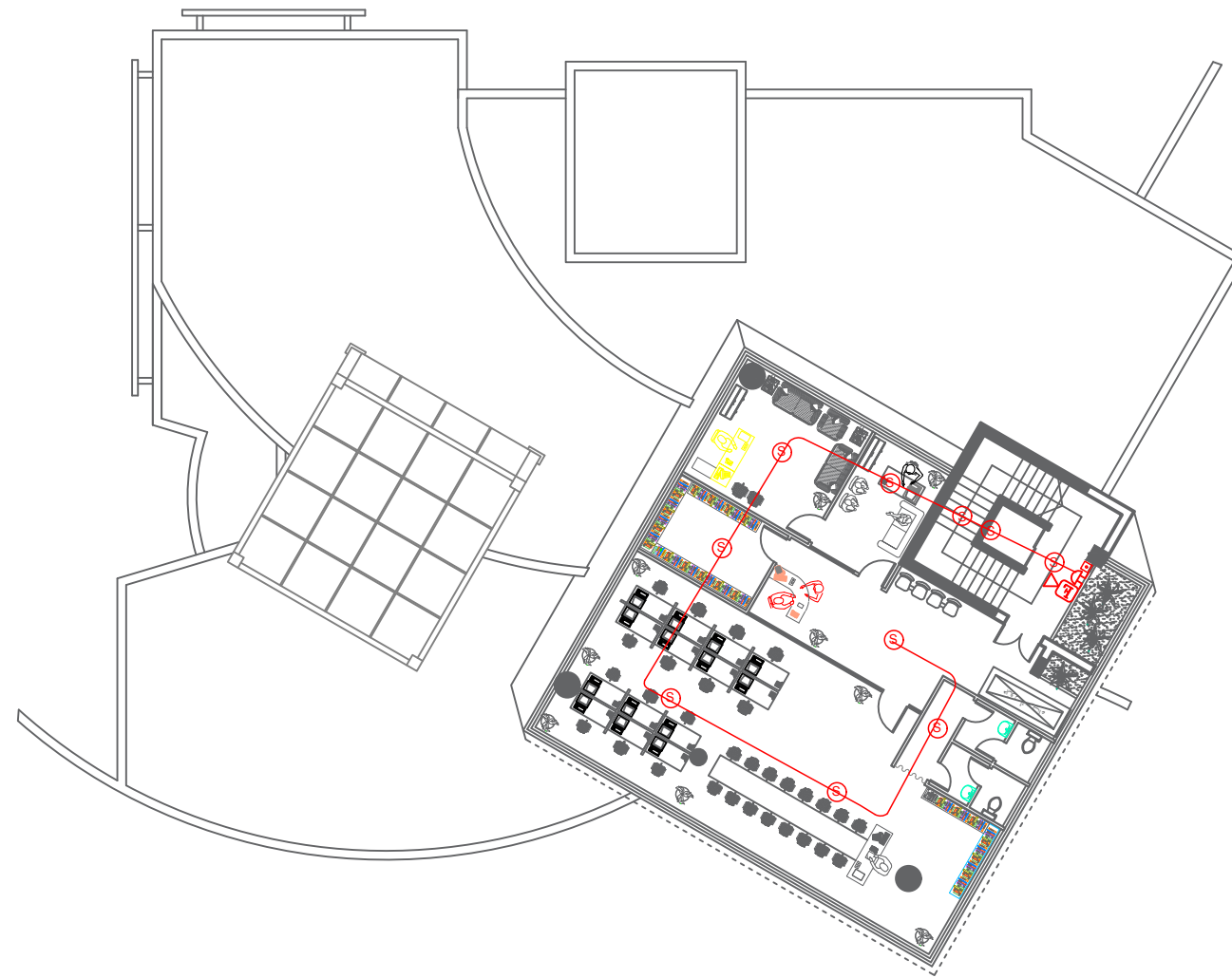

Palestine Polytechnic University
 College of Engineering
 Electrical Department
 Graduation Project

Project name :
 Electrical System, Lighting and
 Supporting Works Design for
 Commercial Mall in Hebron

Drawing Title :
 TE-11

Students Desinger:
 Israa Hasanat
 Marwa abu Muniefe
 Hind Saafin

Supervisor :
 Dr. Fouad Zaro

SCALE	1/100
Sheet Name	9 th - Floor Plan
All Dimensions Are In Meters Unless Otherwise Shown. All Spot Levels Are In Meters.	
DATE: 2021/ 2022	

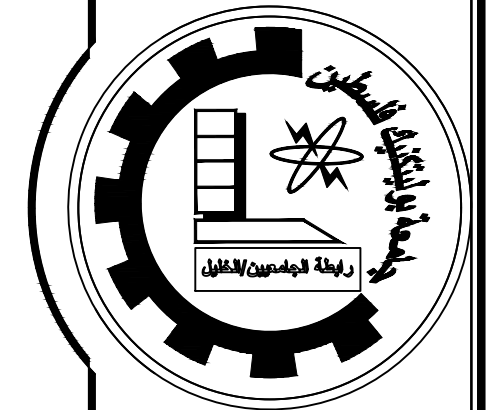
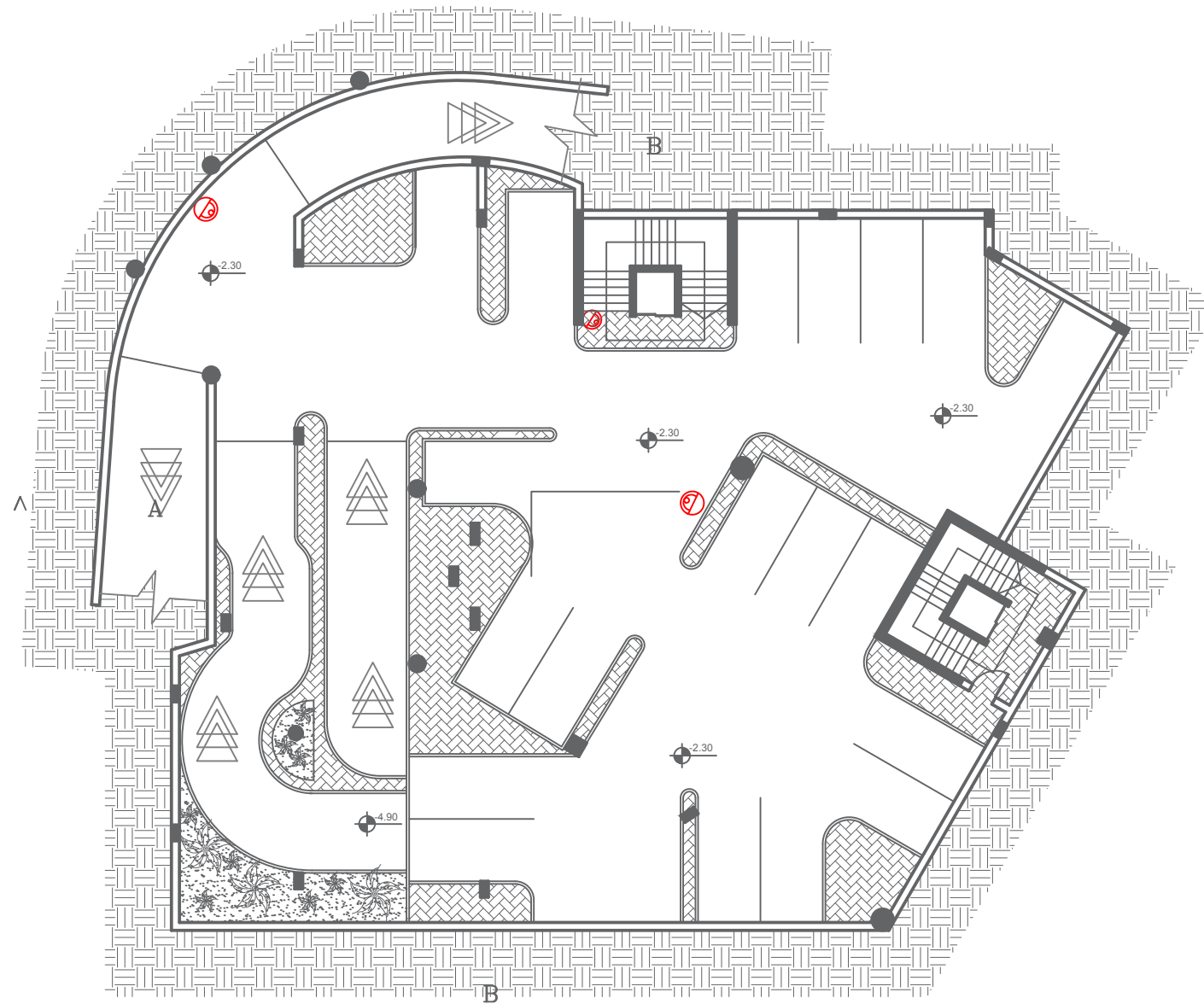

Palestine Polytechnic University
 College of Engineering
 Electrical Department
 Graduation Project

Project name :
 Electrical System, Lighting and
 Supporting Works Design for
 Commercial Mall in Hebron

Drawing Title :
 TE-12

Students Desinger:
 Israa Hasanat
 Marwa abu Muniefe
 Hind Saafin

Supervisor :
 Dr. Fouad Zaro

SCALE	1/100
Sheet Number	Basement2- Floor Plan
All Dimensions Are In Meters Unless Otherwise Shown. All Spot Levels Are In Meters.	
DATE: 2021/ 2022	

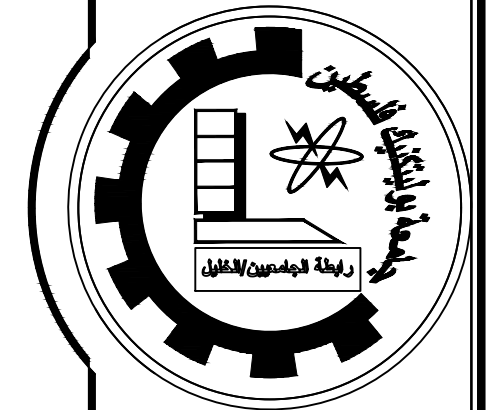

Palestine Polytechnic University
 College of Engineering
 Electrical Department
 Graduation Project

Project name :
 Electrical System, Lighting and
 Supporting Works Design for
 Commercial Mall in Hebron

Drawing Title :
 TE-13

Students Desinger:
 Israa Hasanat
 Marwa abu Muniefe
 Hind Saafin

Supervisor :
 Dr. Fouad Zaro

SCALE	1/100
Sheet Name	Basement1- Floor Plan
All Dimensions Are In Meters Unless Otherwise Shown. All Spot Levels Are In Meters.	
DATE: 2021/ 2022	

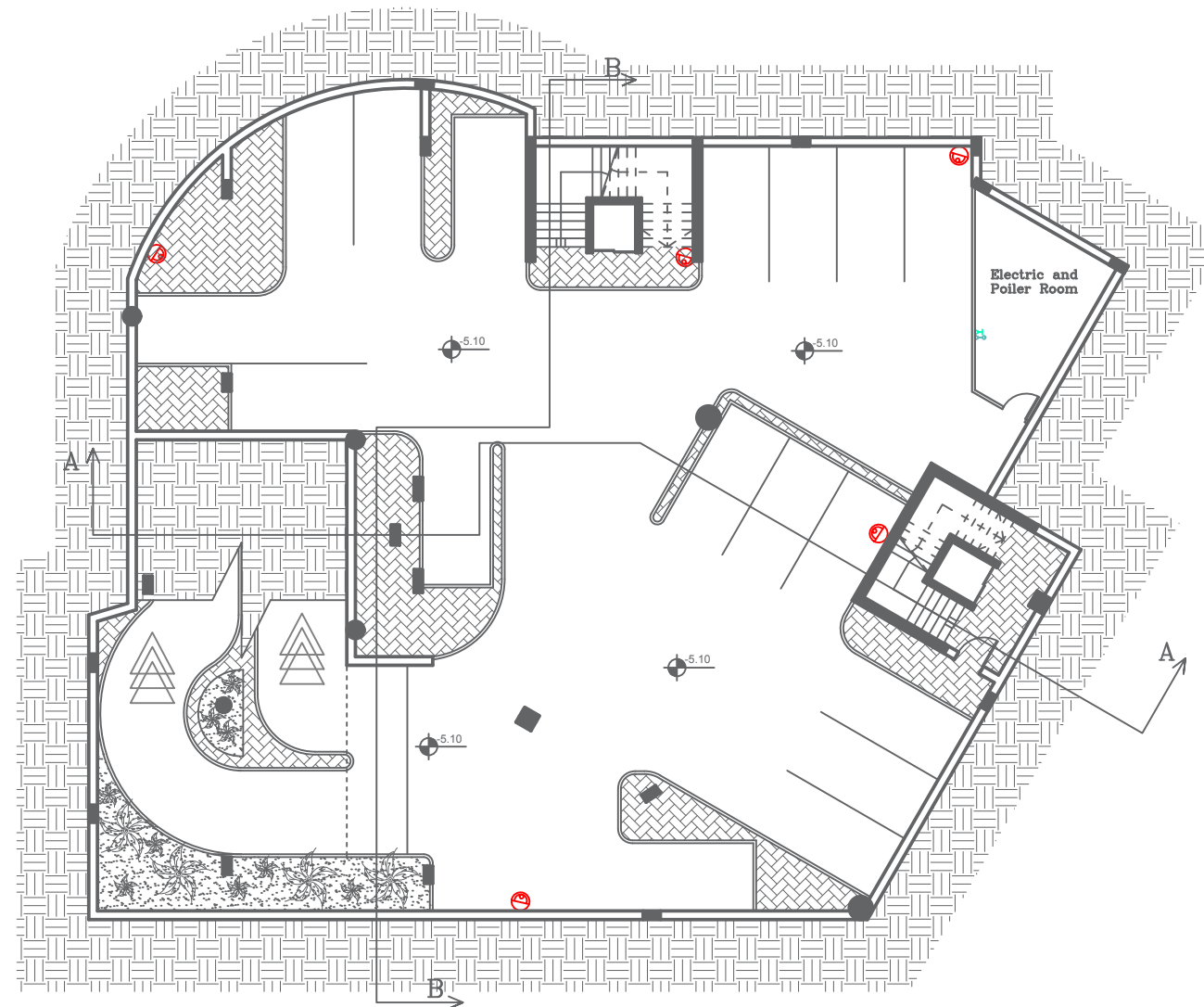

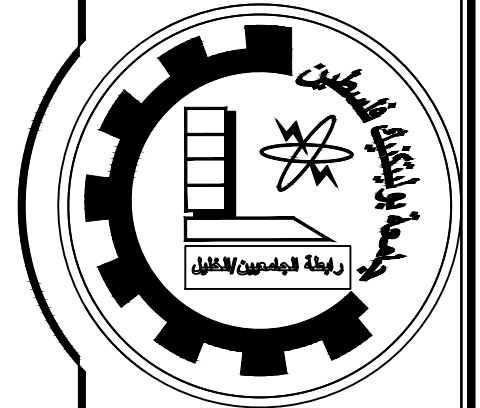
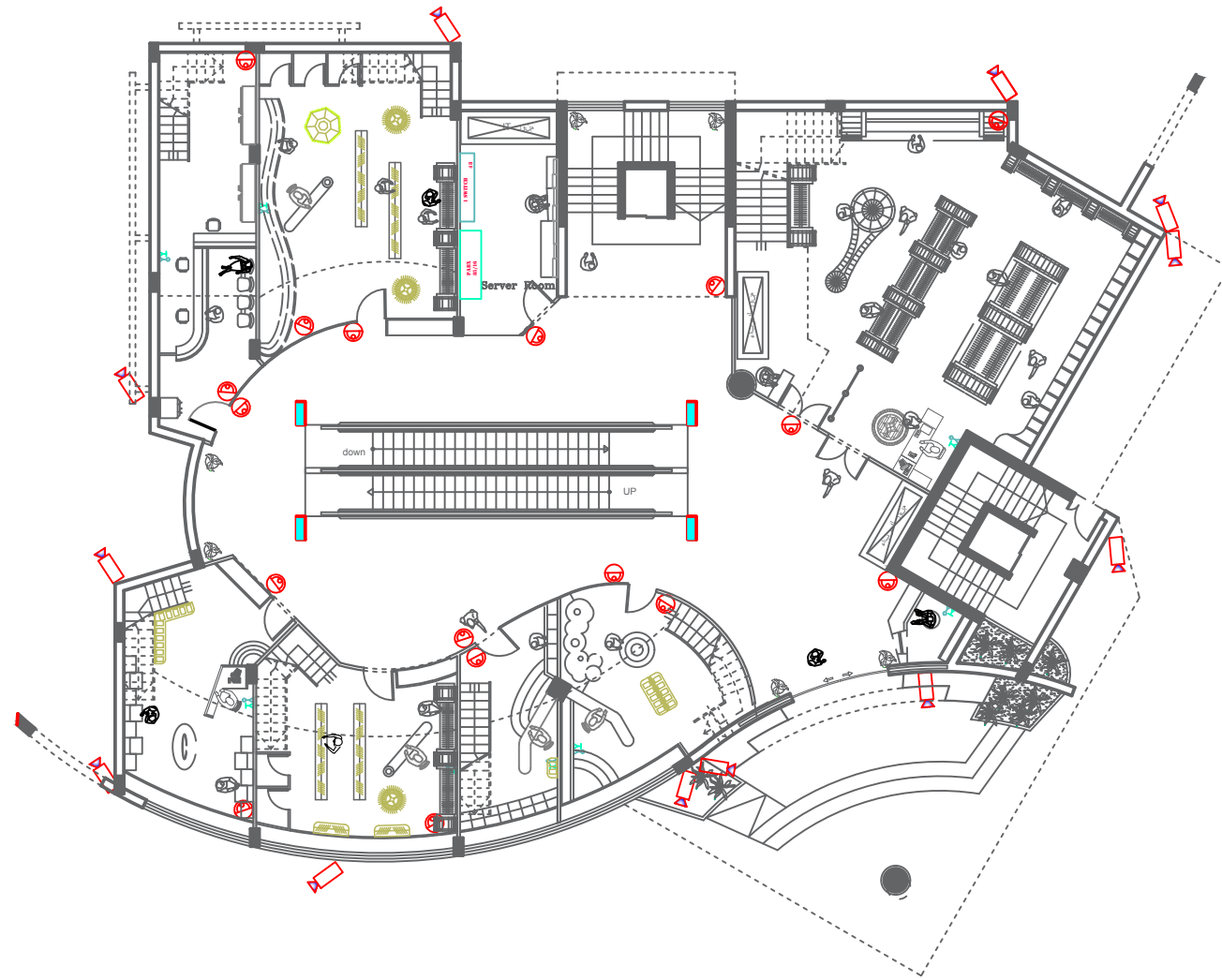

Palestine Polytechnic University
 College of Engineering
 Electrical Department
 Graduation Project

Project name :
 Electrical System, Lighting and
 Supporting Works Design for
 Commercial Mall in Hebron

Drawing Title :
 TE-14

Students Desinger:
 Israa Hasanat
 Marwa abu Muniefe
 Hind Saafin

Supervisor :
 Dr. Fouad Zaro

SCALE	1/100
Sheet Name	Ground Floor Plan
All Dimensions Are In Meters Unless Otherwise Shown. All Spot Levels Are In Meters.	
DATE: 2021/ 2022	

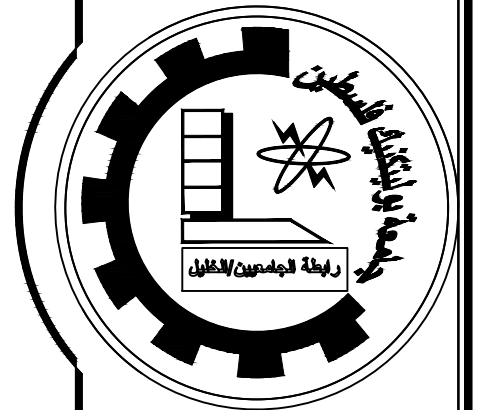
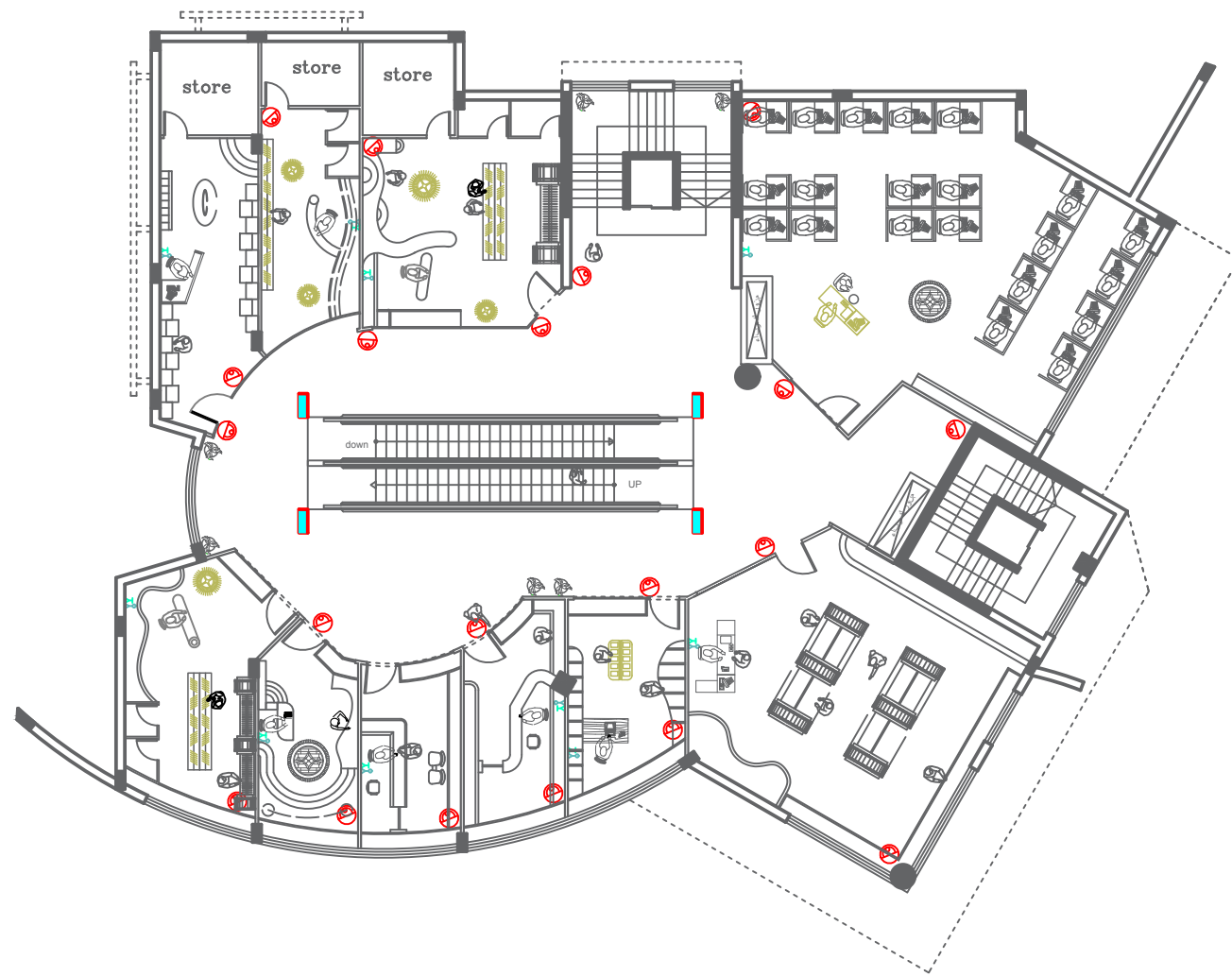

Palestine Polytechnic University
 College of Engineering
 Electrical Department
 Graduation Project

Project name :
 Electrical System, Lighting and
 Supporting Works Design for
 Commercial Mall in Hebron

Drawing Title :
 TE-15

Students Desinger:
 Israa Hasanat
 Marwa abu Muniefe
 Hind Saafin

Supervisor :
 Dr. Fouad Zaro

SCALE	1/100
Sheet Name	1 - Floor Plan
All Dimensions Are In Meters Unless Otherwise Shown. All Spot Levels Are In Meters.	
DATE: 2021/ 2022	

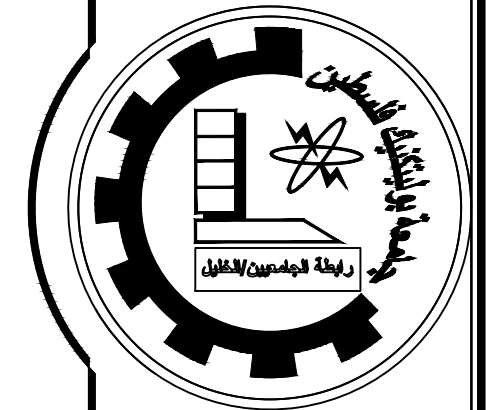
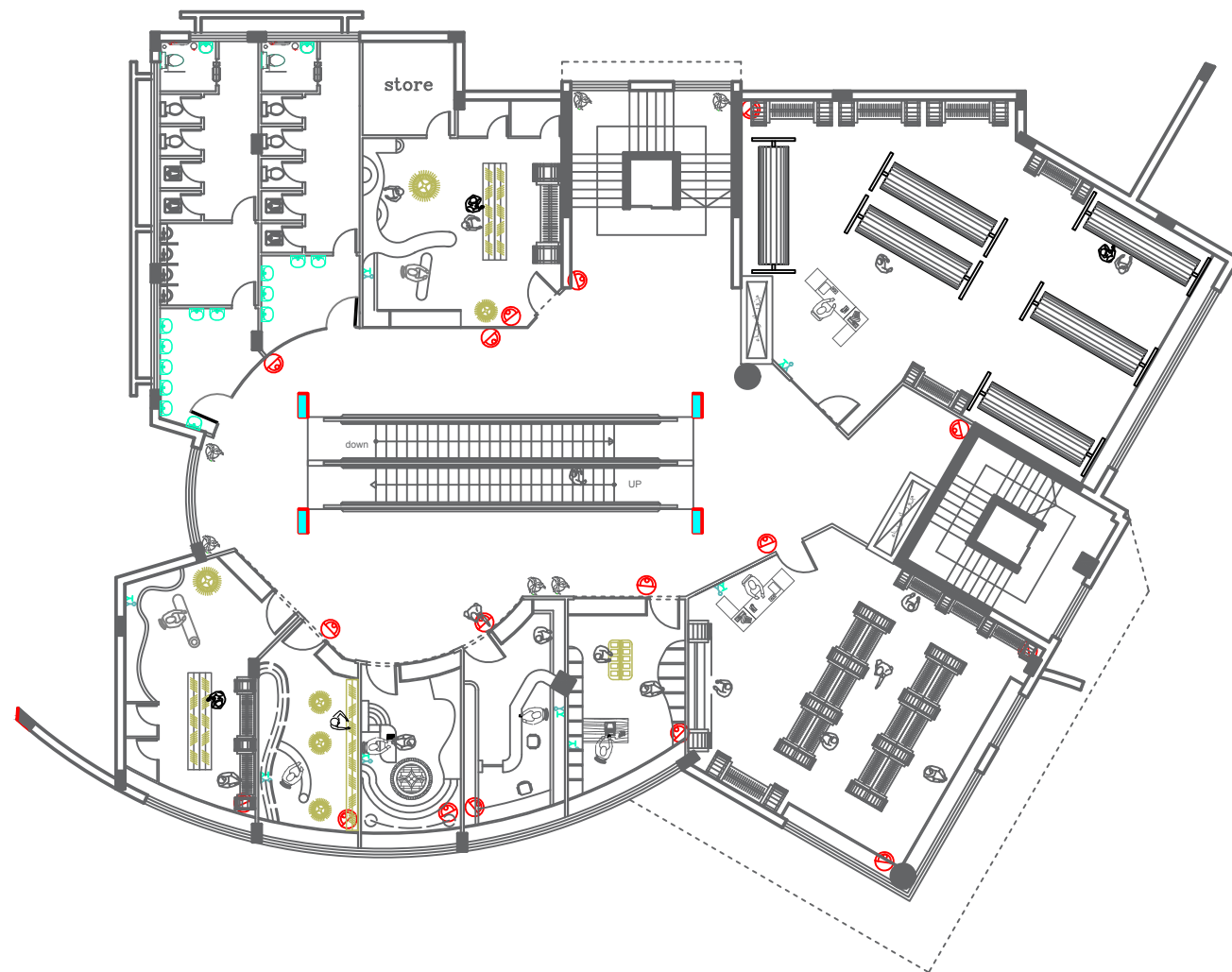

Palestine Polytechnic University
 College of Engineering
 Electrical Department
 Graduation Project

Project name :
 Electrical System, Lighting and
 Supporting Works Design for
 Commercial Mall in Hebron

Drawing Title :
 TE-16

Students Desinger:
 Israa Hasanat
 Marwa abu Muniefe
 Hind Saafin

Supervisor :
 Dr. Fouad Zaro

SCALE	1/100
Sheet Name	2 nd - Floor Plan
All Dimensions Are In Meters Unless Otherwise Shown. All Spot Levels Are In Meters.	
DATE: 2021/ 2022	

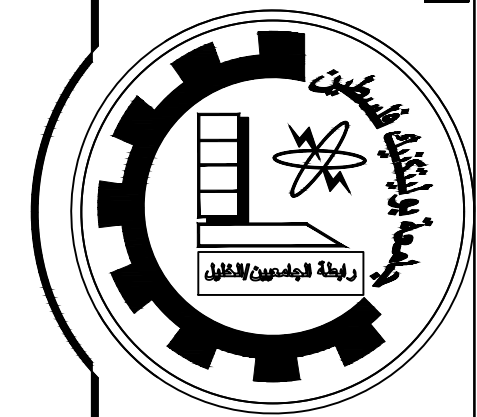
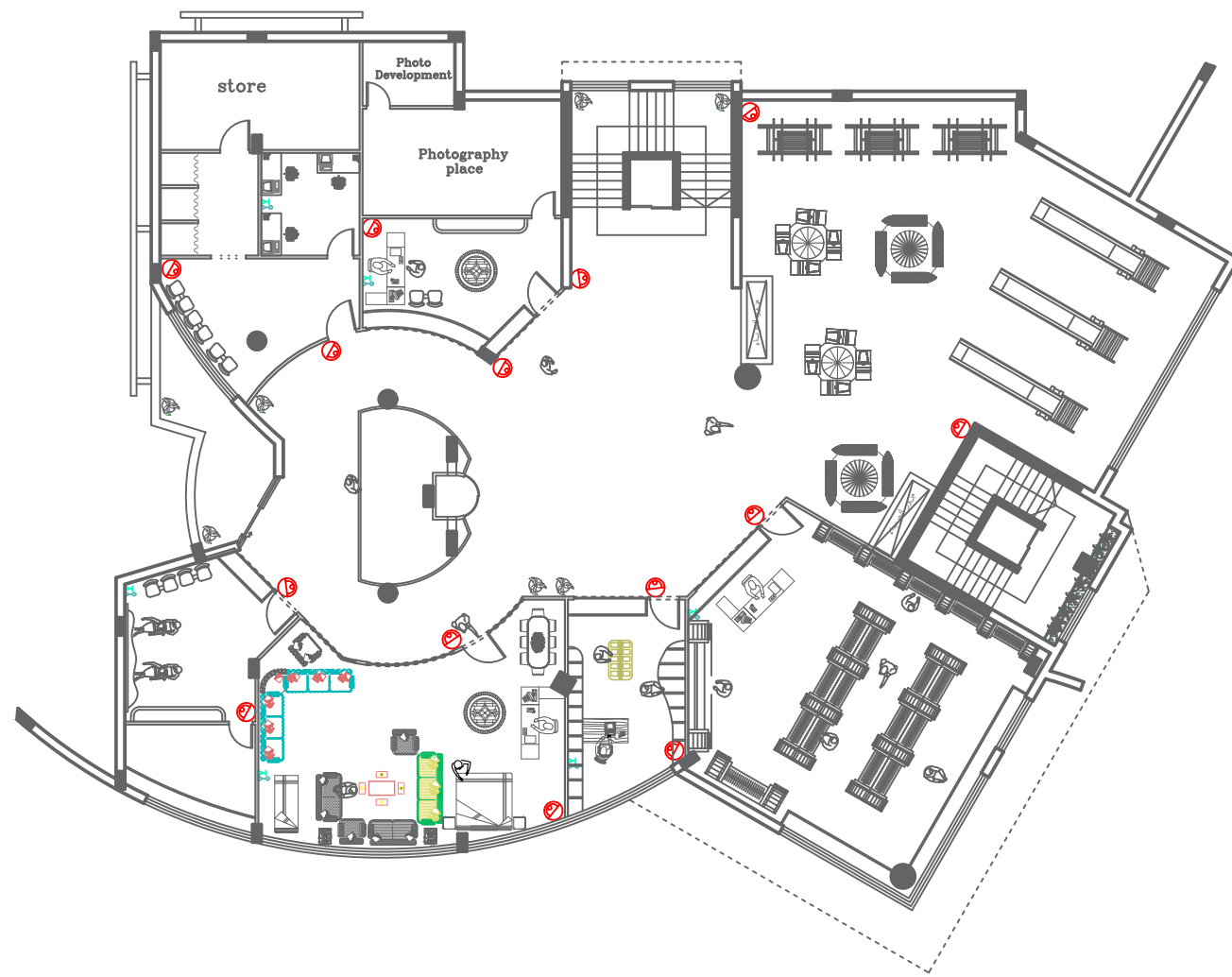

Palestine Polytechnic University
 College of Engineering
 Electrical Department
 Graduation Project

Project name :
 Electrical System, Lighting and
 Supporting Works Design for
 Commercial Mall in Hebron

Drawing Title :
 TE-17

Students Desinger:
 Israa Hasanat
 Marwa abu Muniefe
 Hind Saafin

Supervisor :
 Dr. Fouad Zaro

SCALE	1/100
Sheet Name	3 rd - Floor Plan
All Dimensions Are In Meters Unless Otherwise Shown. All Spot Levels Are In Meters.	
DATE: 2021/ 2022	

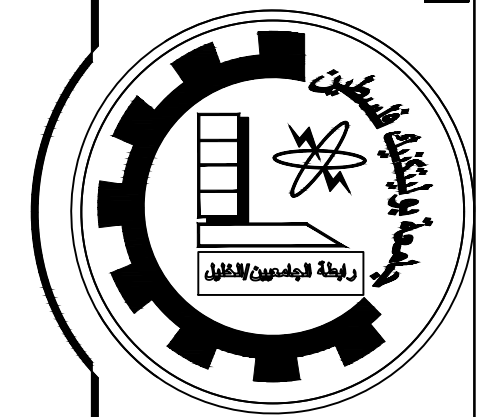
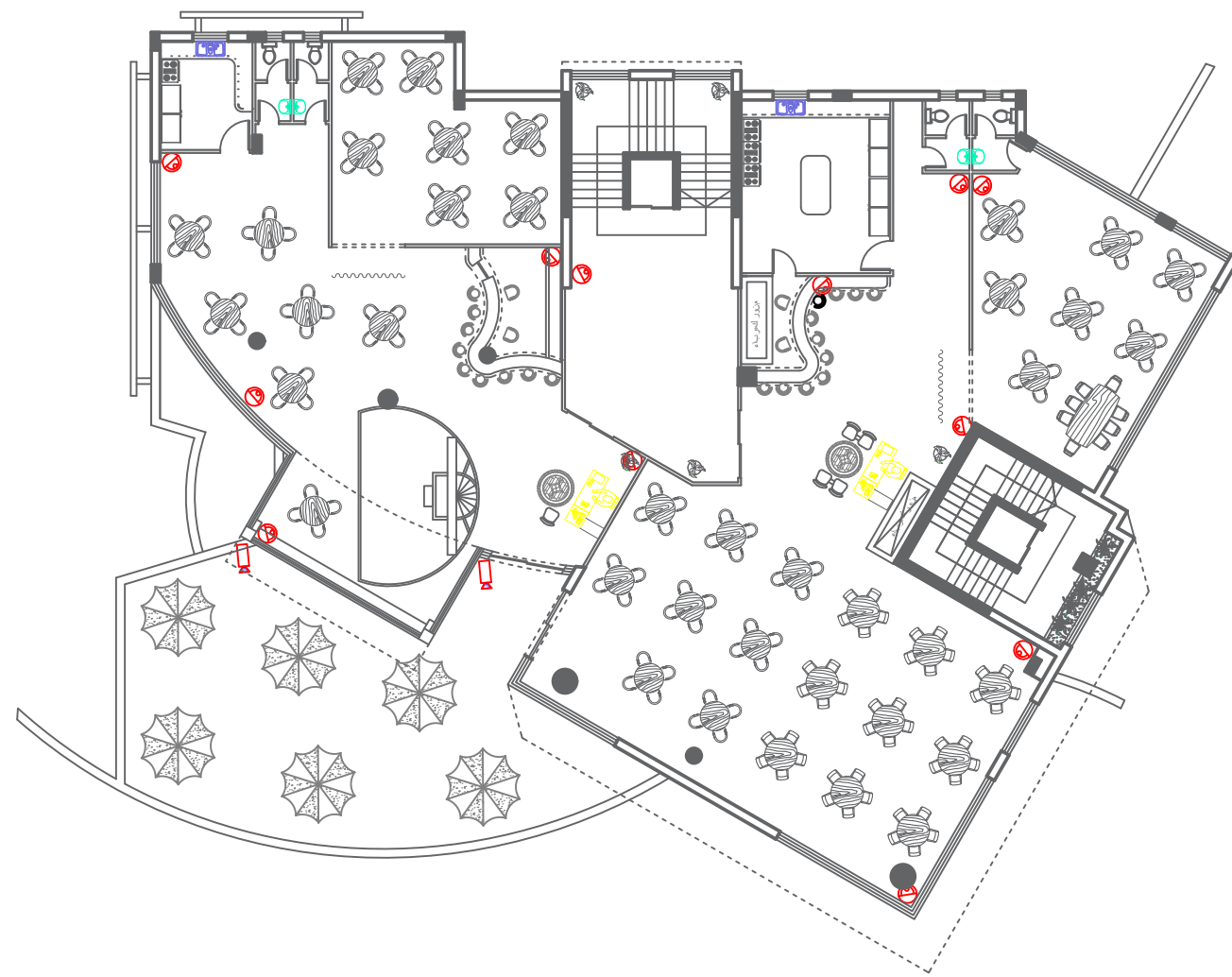

Palestine Polytechnic University
 College of Engineering
 Electrical Department
 Graduation Project

Project name :
 Electrical System, Lighting and
 Supporting Works Design for
 Commercial Mall in Hebron

Drawing Title :
 TE-18

Students Desinger:
 Israa Hasanat
 Marwa abu Muniefe
 Hind Saafin

Supervisor :
 Dr. Fouad Zaro

SCALE	1/100
Sheet Name	4 th - Floor Plan
All Dimensions Are In Meters Unless Otherwise Shown. All Spot Levels Are In Meters.	
DATE: 2021/ 2022	

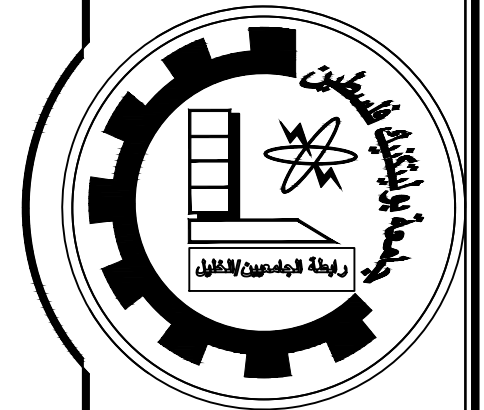
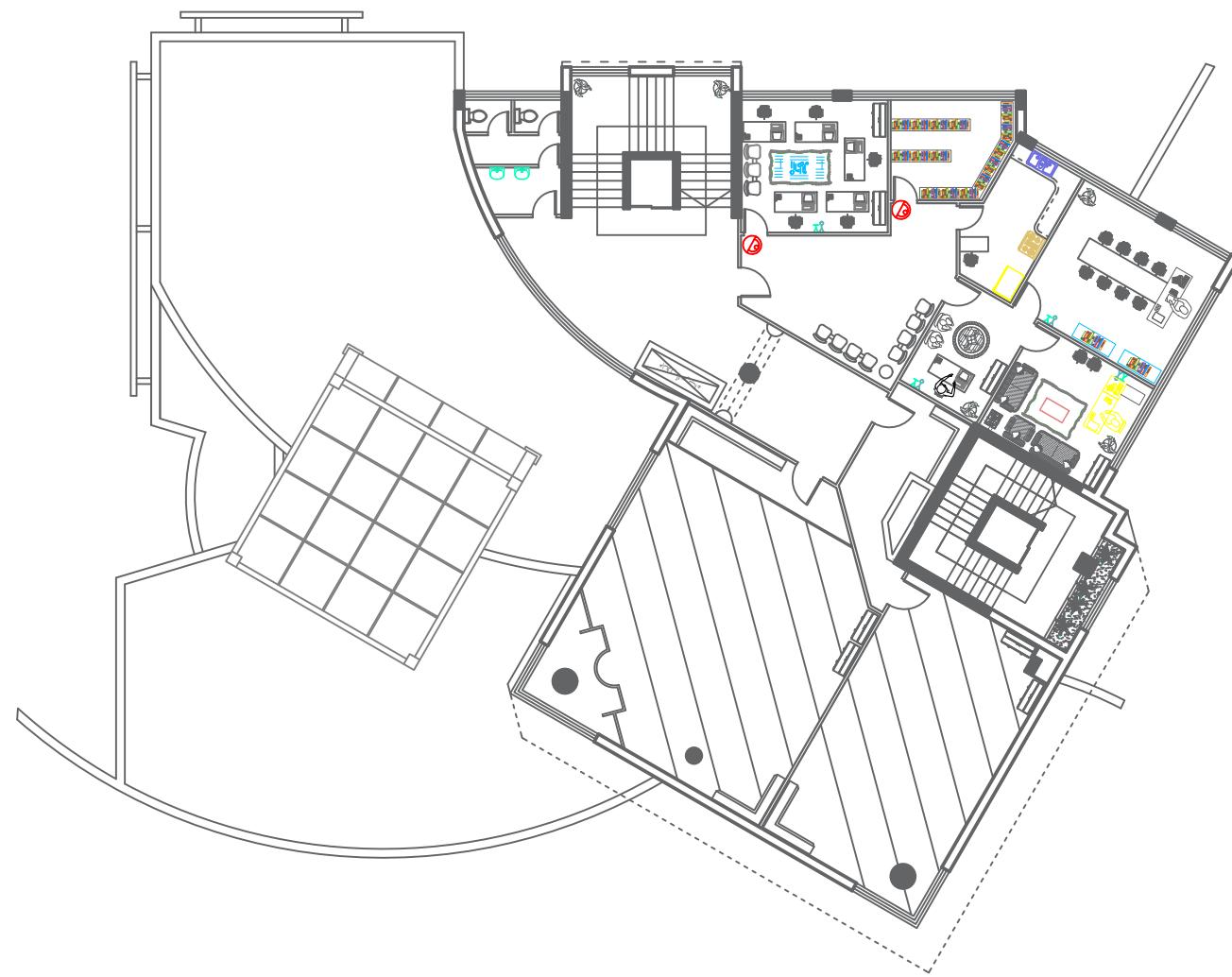

Palestine Polytechnic University
 College of Engineering
 Electrical Department
 Graduation Project

Project name :
 Electrical System, Lighting and
 Supporting Works Design for
 Commercial Mall in Hebron

Drawing Title :
 TE-19

Students Desinger:
 Israa Hasanat
 Marwa abu Muniefe
 Hind Saafin

Dr. Fouad Zaro

SCALE	1/100
Sheet Name	5 th - Floor Plan
All Dimensions Are In Meters Unless Otherwise Shown. All Spot Levels Are In Meters.	
DATE: 2021/ 2022	

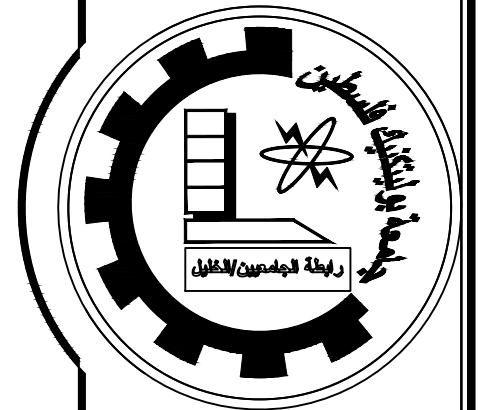
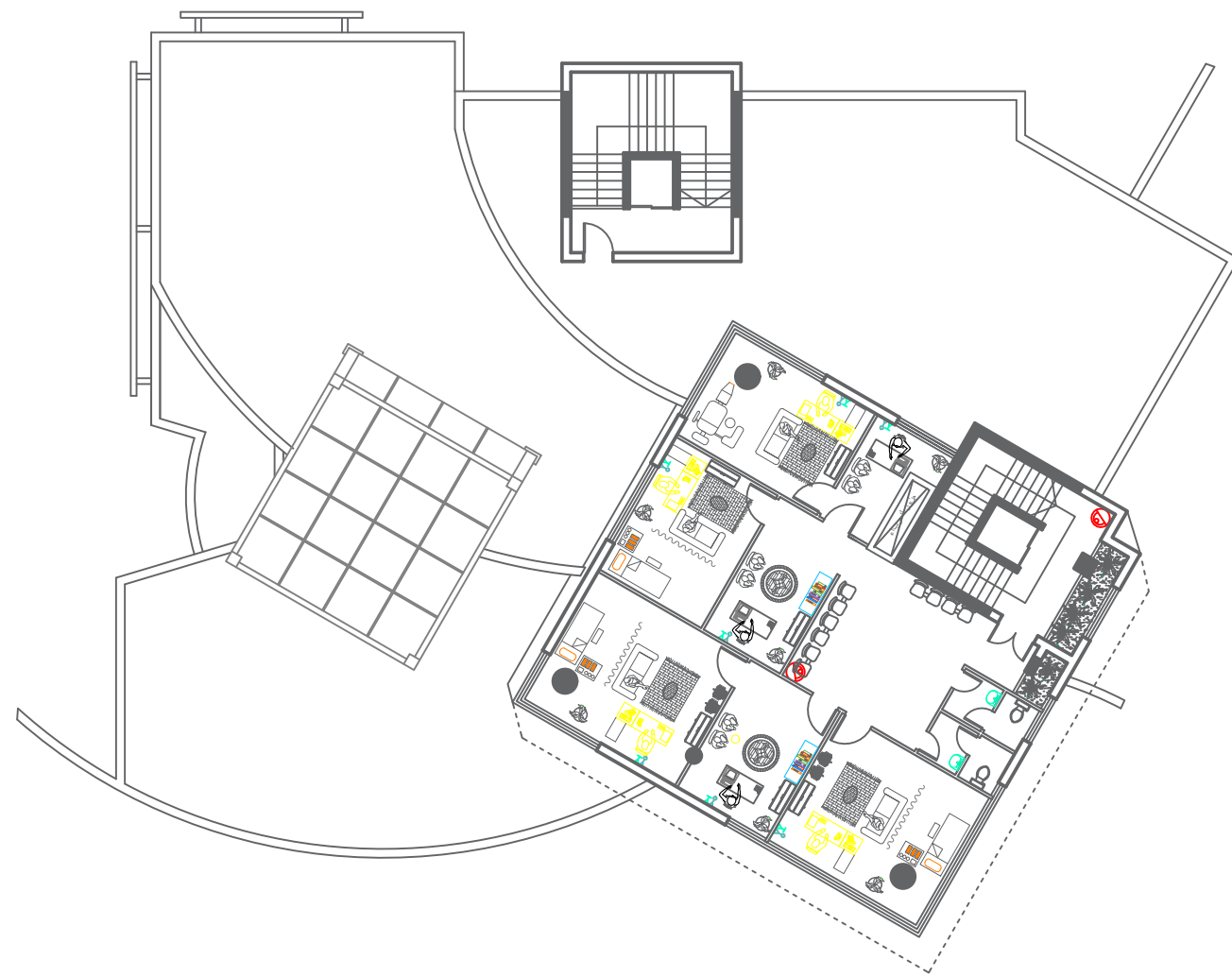

Palestine Polytechnic University
 College of Engineering
 Electrical Department
 Graduation Project

Project name :
 Electrical System, Lighting and
 Supporting Works Design for
 Commercial Mall in Hebron

Drawing Title :
 TE-20

Students Desinger:
 Israa Hasanat
 Marwa abu Muniefe
 Hind Saafin

Supervisor :
 Dr. Fouad Zaro

SCALE	1/100
Sheet Name	6 th - Floor Plan
All Dimensions Are In Meters Unless Otherwise Shown. All Spot Levels Are In Meters.	
DATE: 2021/ 2022	

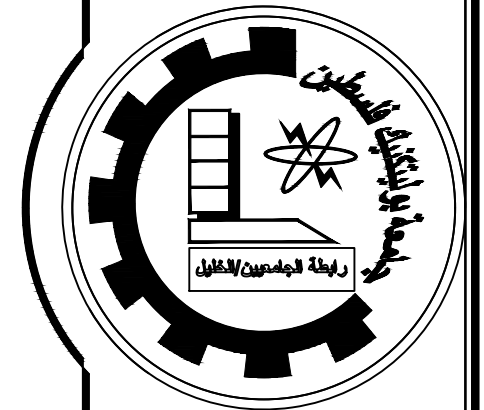

Palestine Polytechnic University
 College of Engineering
 Electrical Department
 Graduation Project

Project name :
 Electrical System, Lighting and
 Supporting Works Design for
 Commercial Mall in Hebron

Drawing Title :
 TE-21

Students Desinger:
 Israa Hasanat
 Marwa abu Muniefe
 Hind Saafin

Supervisor :
 Dr. Fouad Zaro

SCALE	1/100
Sheet Name	7 ^m - Floor Plan
All Dimensions Are In Meters Unless Otherwise Shown. All Spot Levels Are In Meters.	
DATE: 2021/ 2022	

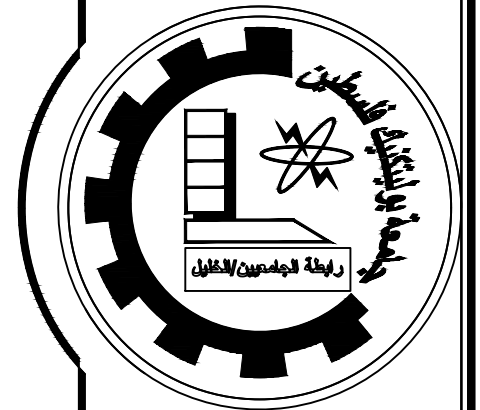
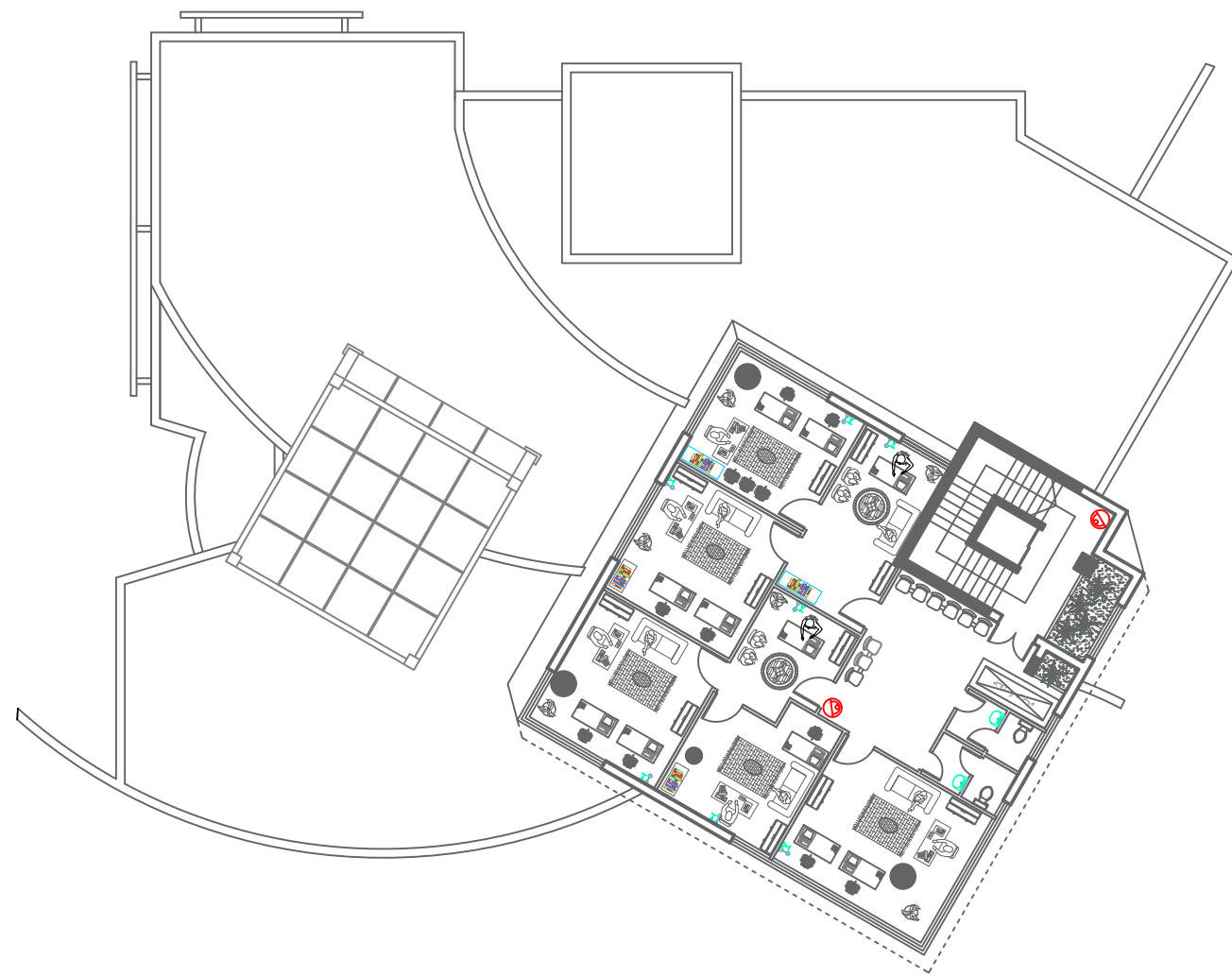

Palestine Polytechnic University
 College of Engineering
 Electrical Department
 Graduation Project

Project name :
 Electrical System, Lighting and
 Supporting Works Design for
 Commercial Mall in Hebron

Drawing Title :
 TE-22

Students Desinger:
 Israa Hasanat
 Marwa abu Muniefe
 Hind Saafin

Supervisor :
 Dr. Fouad Zaro

SCALE	1/100
Sheet Name	8 th - Floor Plan
All Dimensions Are In Meters Unless Otherwise Shown. All Spot Levels Are In Meters.	
DATE: 2021/ 2022	

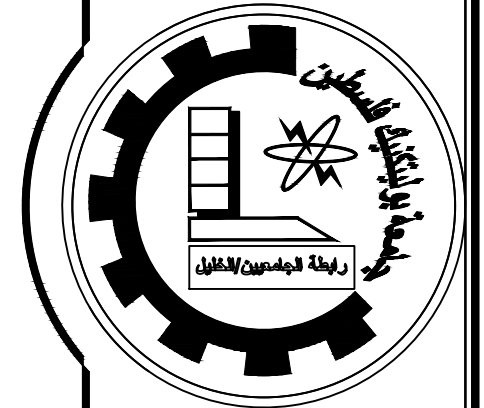
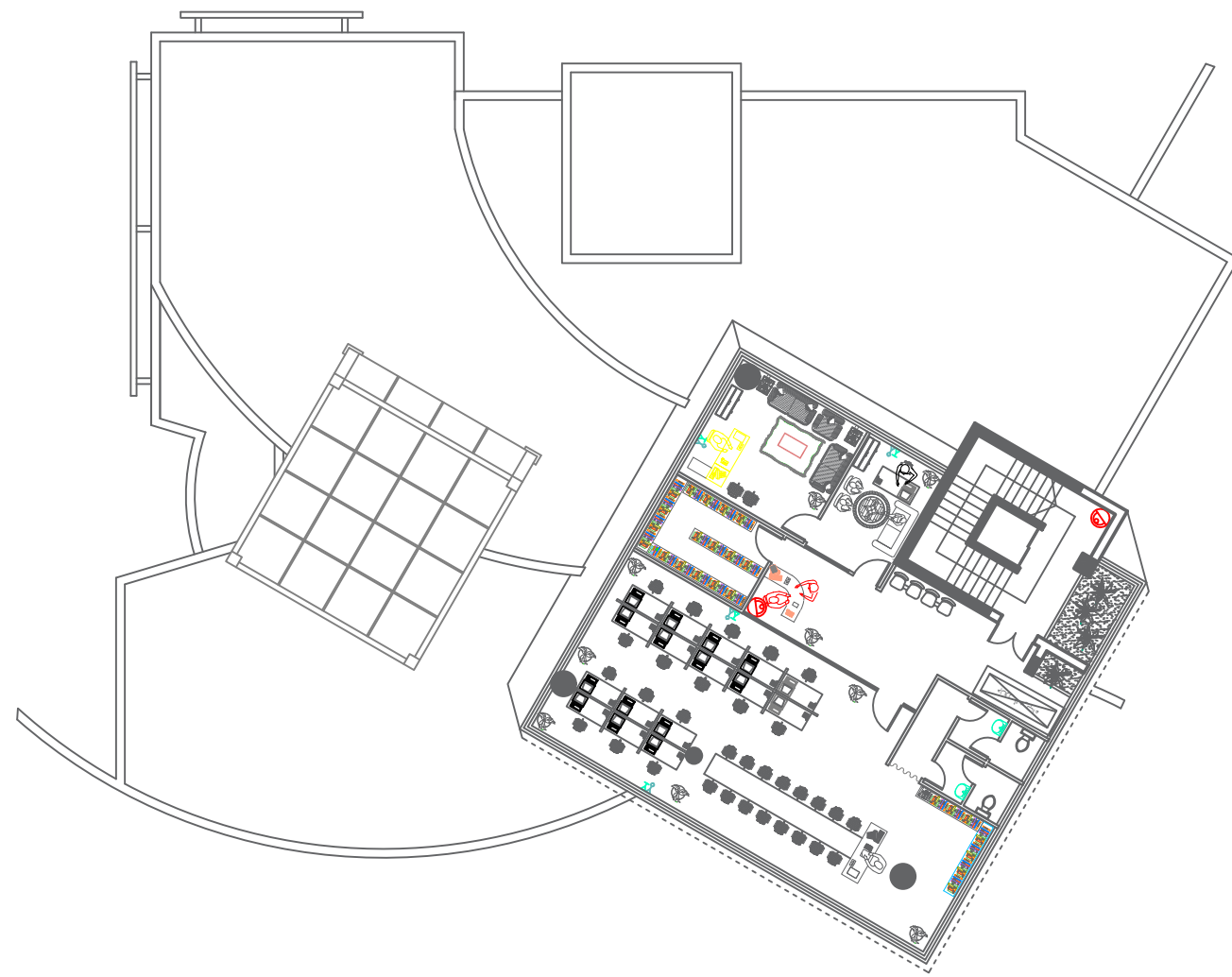

Palestine Polytechnic University
College of Engineering
Electrical Department
Graduation Project

Project name :
Electrical System, Lighting and
Supporting Works Design for
Commercial Mall in Hebron

Drawing Title :
TE-23

Students Desinger:
Israa Hasanat
Marwa abu Muniefe
Hind Saafin

Supervisor :
Dr. Fouad Zaro

SCALE	1/100
Sheet Name	9 th - Floor Plan
All Dimensions Are In Meters Unless Otherwise Shown. All Spot Levels Are In Meters.	
DATE: 2021/ 2022	

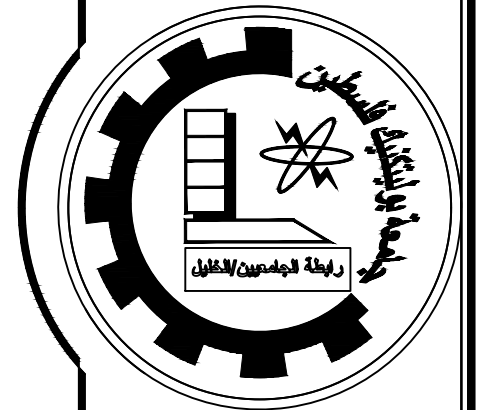
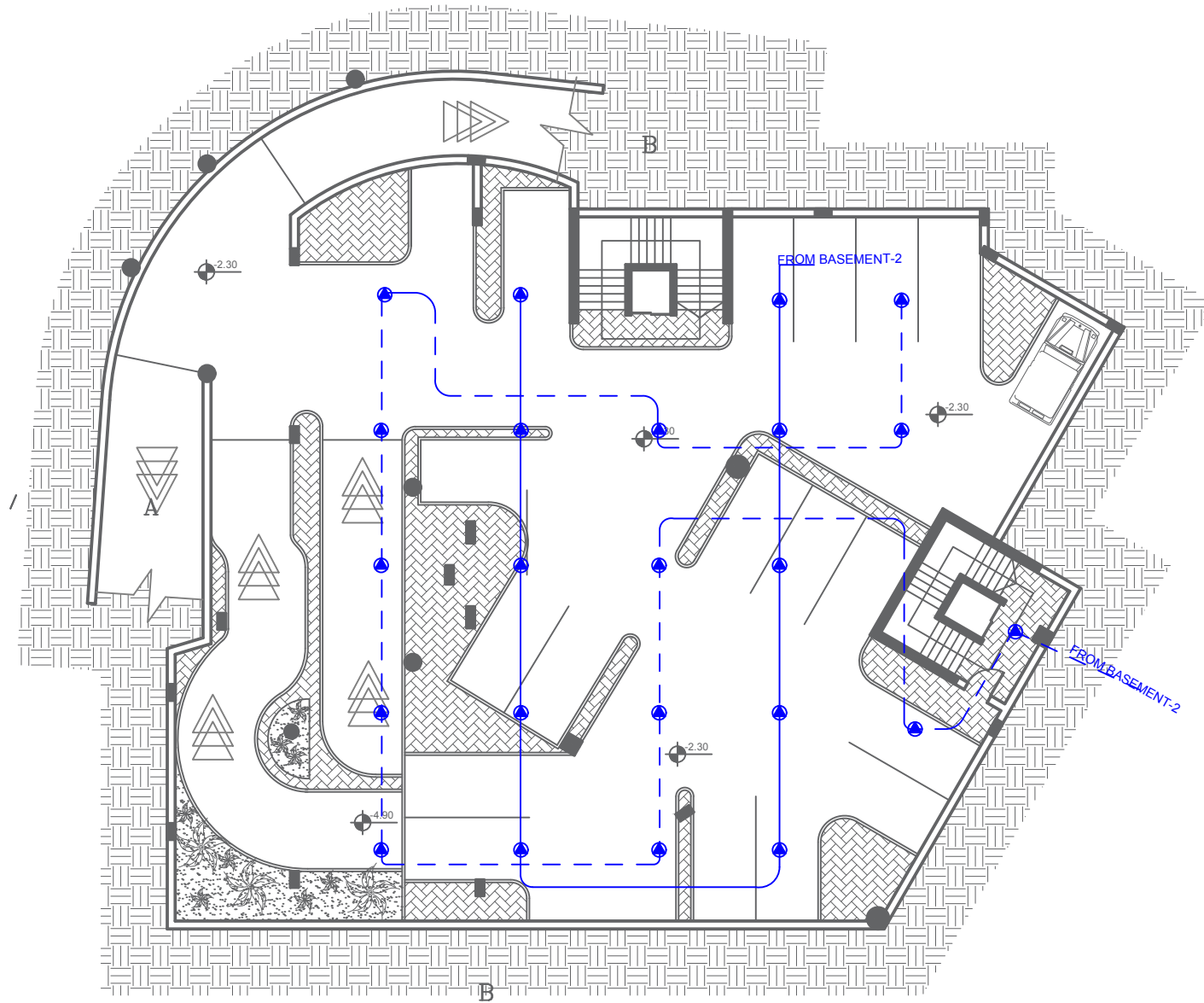

Palestine Polytechnic University
 College of Engineering
 Electrical Department
 Graduation Project

Project name :
 Electrical System, Lighting and
 Supporting Works Design for
 Commercial Mall in Hebron

Drawing Title :
 TE-24

Students Desinger:
 Israa Hasanat
 Marwa abu Muniefe
 Hind Saafin

Supervisor :
 Dr. Fouad Zaro

SCALE	1/100
Sheet Number	Basement2- Floor Plan
All Dimensions Are In Meters Unless Otherwise Shown. All Spot Levels Are In Meters.	
DATE: 2021/ 2022	

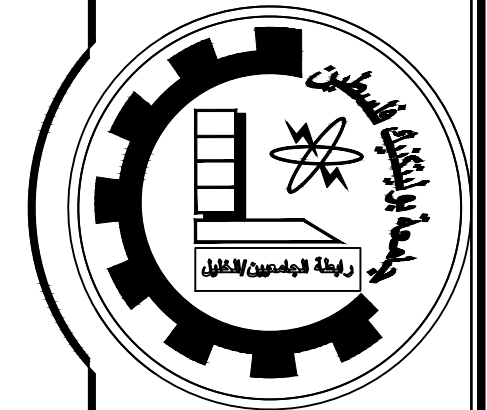

Palestine Polytechnic University
 College of Engineering
 Electrical Department
 Graduation Project

Project name :
 Electrical System, Lighting and
 Supporting Works Design for
 Commercial Mall in Hebron

Drawing Title :
 TE-25

Students Desinger:
 Israa Hasanat
 Marwa abu Muniefe
 Hind Saafin

Supervisor :
 Dr. Fouad Zaro

SCALE	1/100
Sheet Name	Basement1- Floor Plan
All Dimensions Are In Meters Unless Otherwise Shown. All Spot Levels Are In Meters.	
DATE: 2021/ 2022	

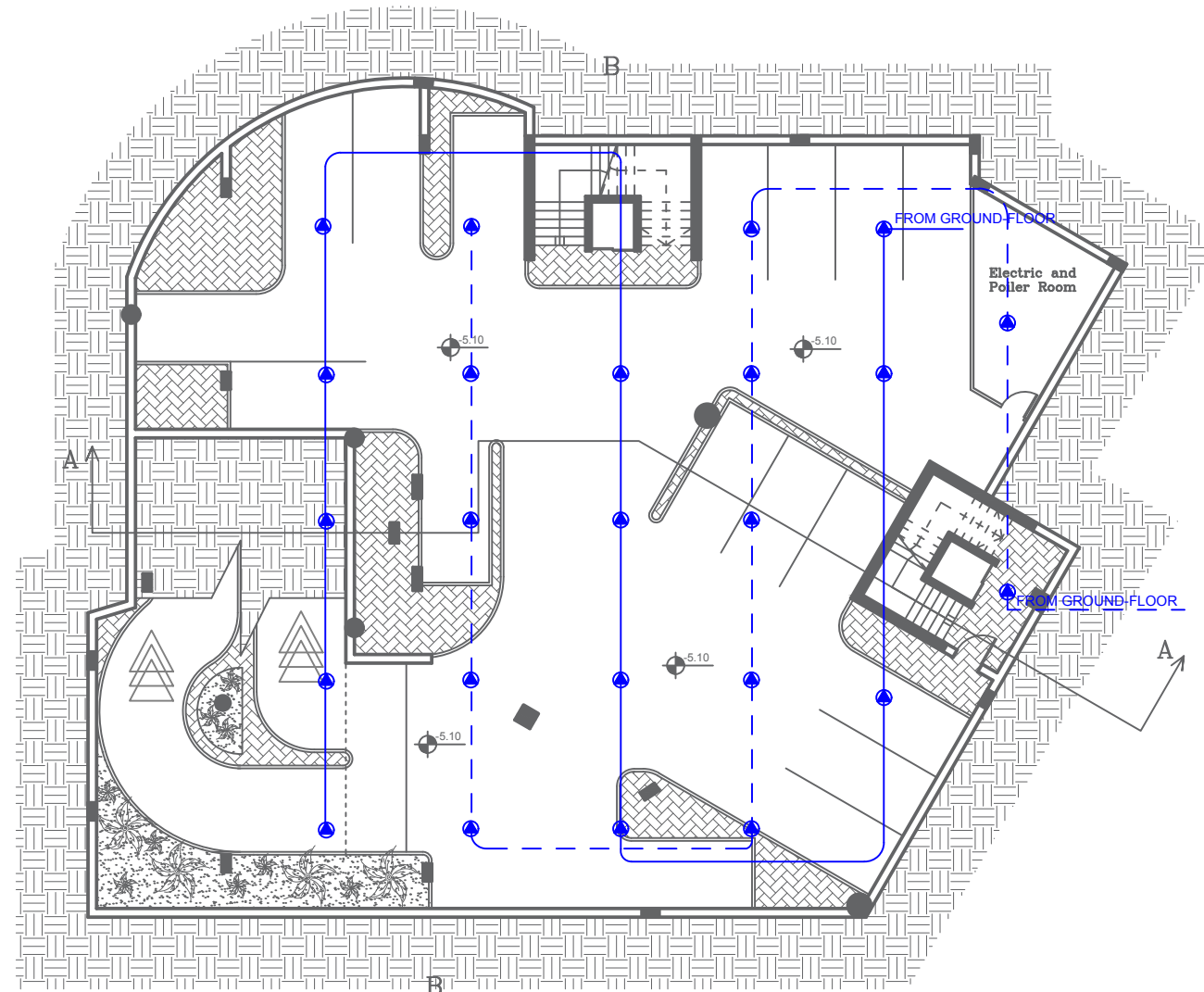

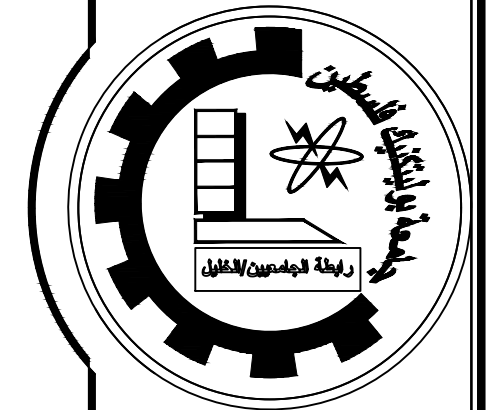
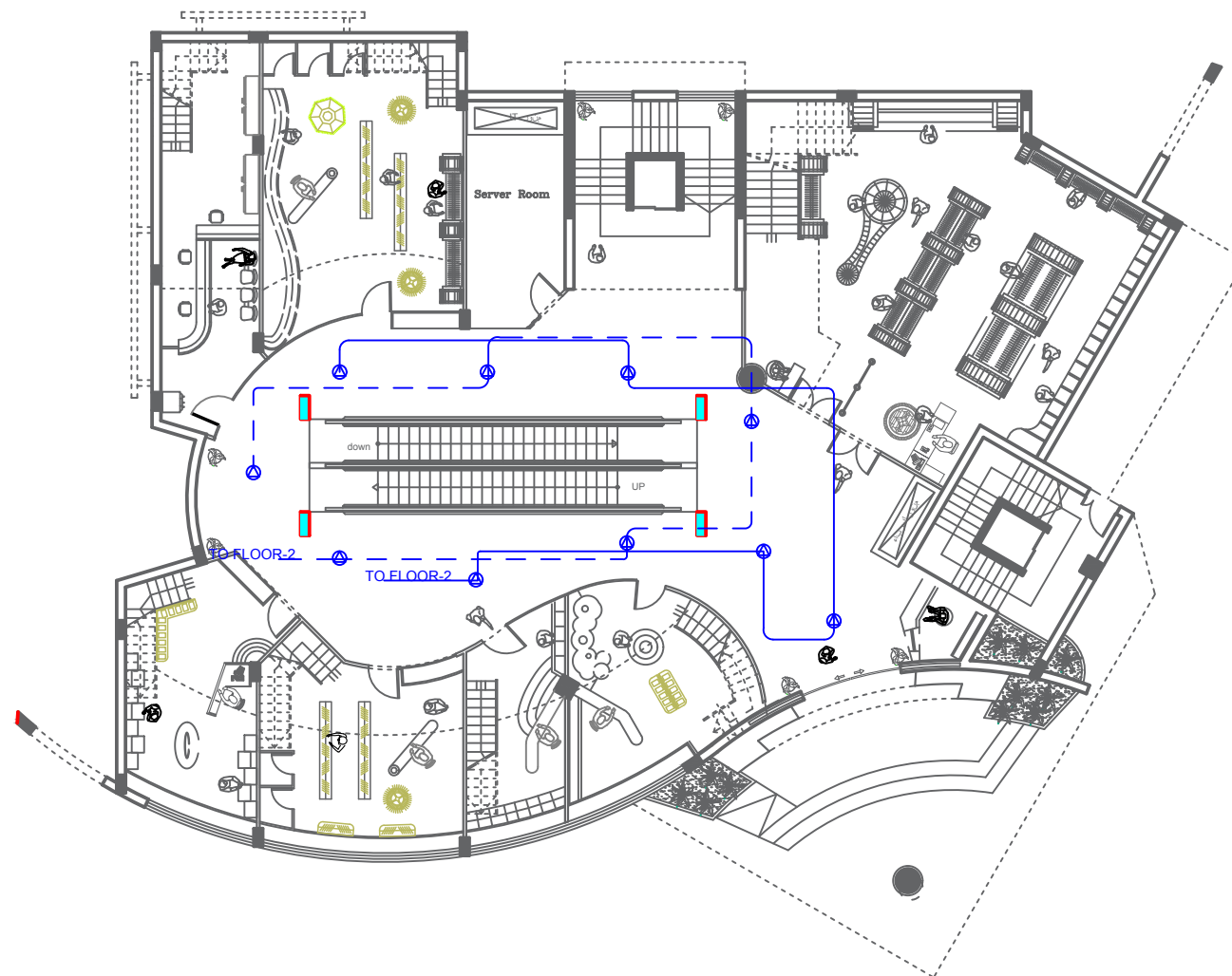

Palestine Polytechnic University
 College of Engineering
 Electrical Department
 Graduation Project

Project name :
 Electrical System, Lighting and
 Supporting Works Design for
 Commercial Mall in Hebron

Drawing Title :
 TE-26

Students Desinger:
 Israa Hasanat
 Marwa abu Muniefe
 Hind Saafin

Supervisor :
 Dr. Fouad Zaro

SCALE	1/100
Sheet Name	Ground Floor Plan
All Dimensions Are In Meters Unless Otherwise Shown. All Spot Levels Are In Meters.	
DATE: 2021/ 2022	

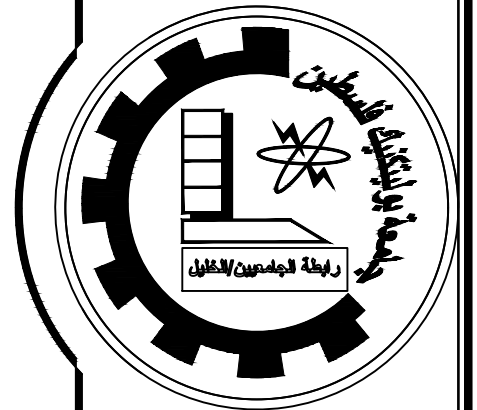
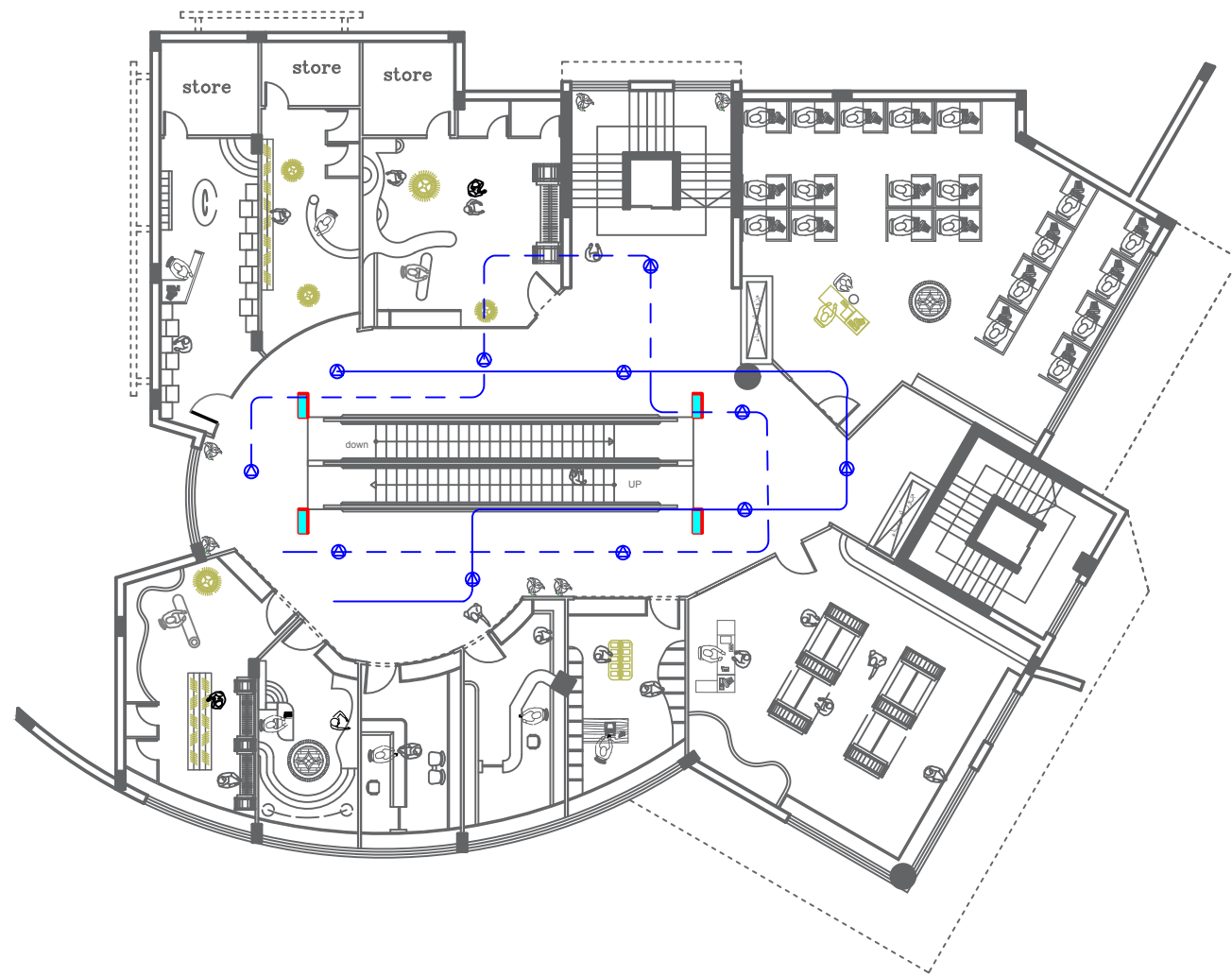

Palestine Polytechnic University
 College of Engineering
 Electrical Department
 Graduation Project

Project name :
 Electrical System, Lighting and
 Supporting Works Design for
 Commercial Mall in Hebron

Drawing Title :
 TE-27

Students Desinger:
 Israa Hasanat
 Marwa abu Muniefe
 Hind Saafin

Supervisor :
 Dr. Fouad Zaro

SCALE	1/100
Sheet Name	1 st - Floor Plan
All Dimensions Are In Meters Unless Otherwise Shown. All Spot Levels Are In Meters.	
DATE: 2021/ 2022	

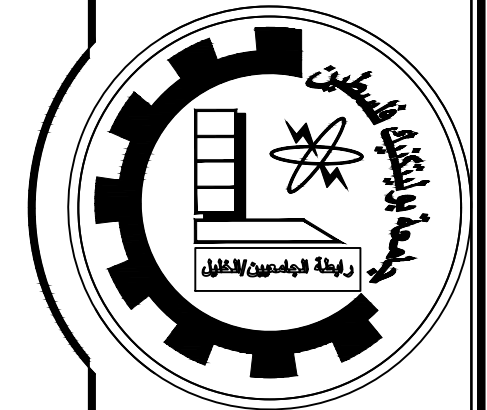
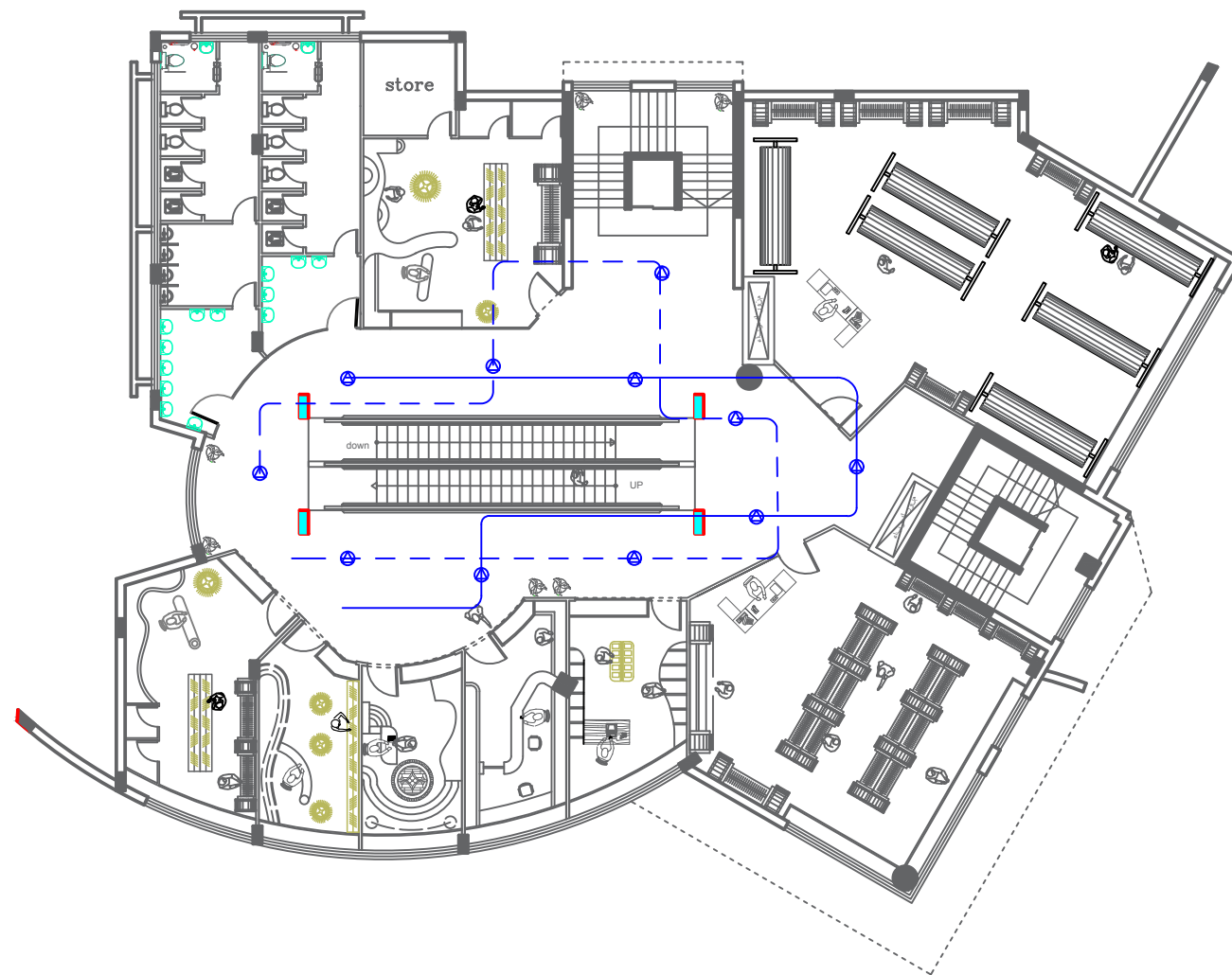

Palestine Polytechnic University
 College of Engineering
 Electrical Department
 Graduation Project

Project name :
 Electrical System, Lighting and
 Supporting Works Design for
 Commercial Mall in Hebron

Drawing Title :
 TE-28

Students Desinger:
 Israa Hasanat
 Marwa abu Muniefe
 Hind Saafin

Supervisor :
 Dr. Fouad Zaro

SCALE	1/100
Sheet Name	2 nd - Floor Plan
All Dimensions Are In Meters Unless Otherwise Shown. All Spot Levels Are In Meters.	
DATE: 2021/ 2022	

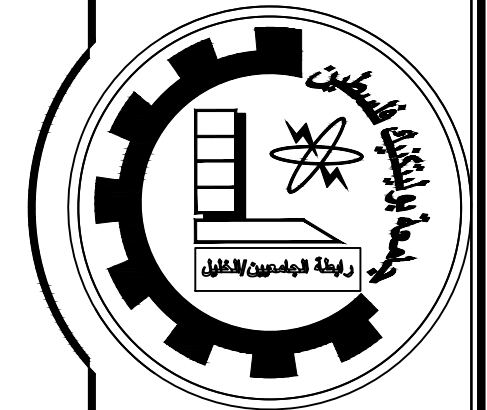
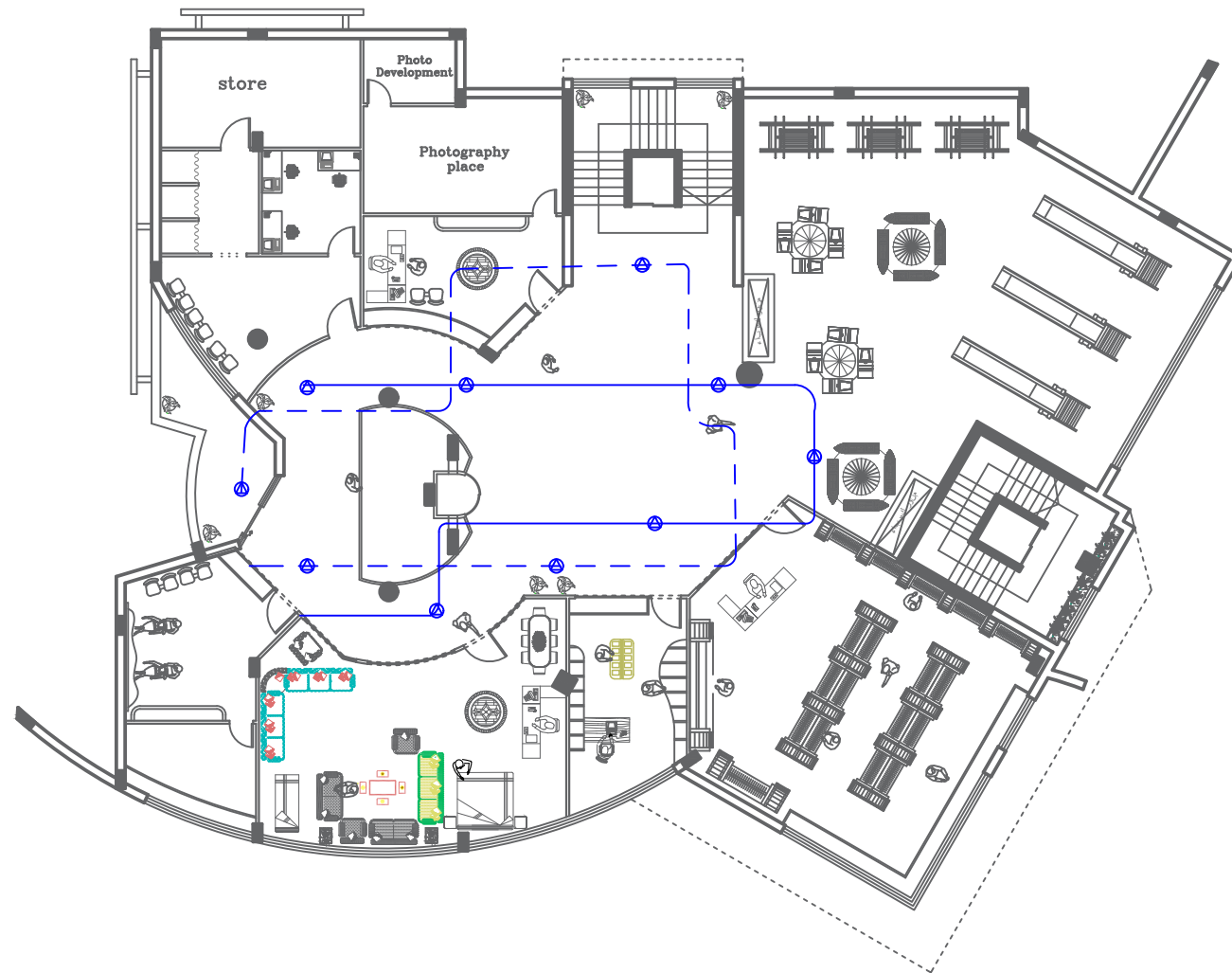

Palestine Polytechnic University
 College of Engineering
 Electrical Department
 Graduation Project

Project name :
 Electrical System, Lighting and
 Supporting Works Design for
 Commercial Mall in Hebron

Drawing Title :
 TE-29

Students Desinger:
 Israa Hasanat
 Marwa abu Muniefe
 Hind Saafin

Supervisor :
 Dr. Fouad Zaro

SCALE	1/100
Sheet Name	3 rd - Floor Plan
All Dimensions Are In Meters Unless Otherwise Shown. All Spot Levels Are In Meters.	
DATE: 2021/ 2022	

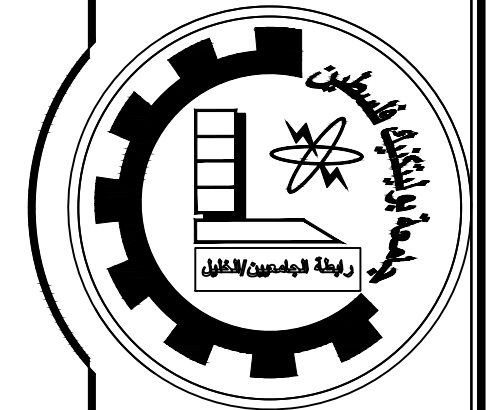
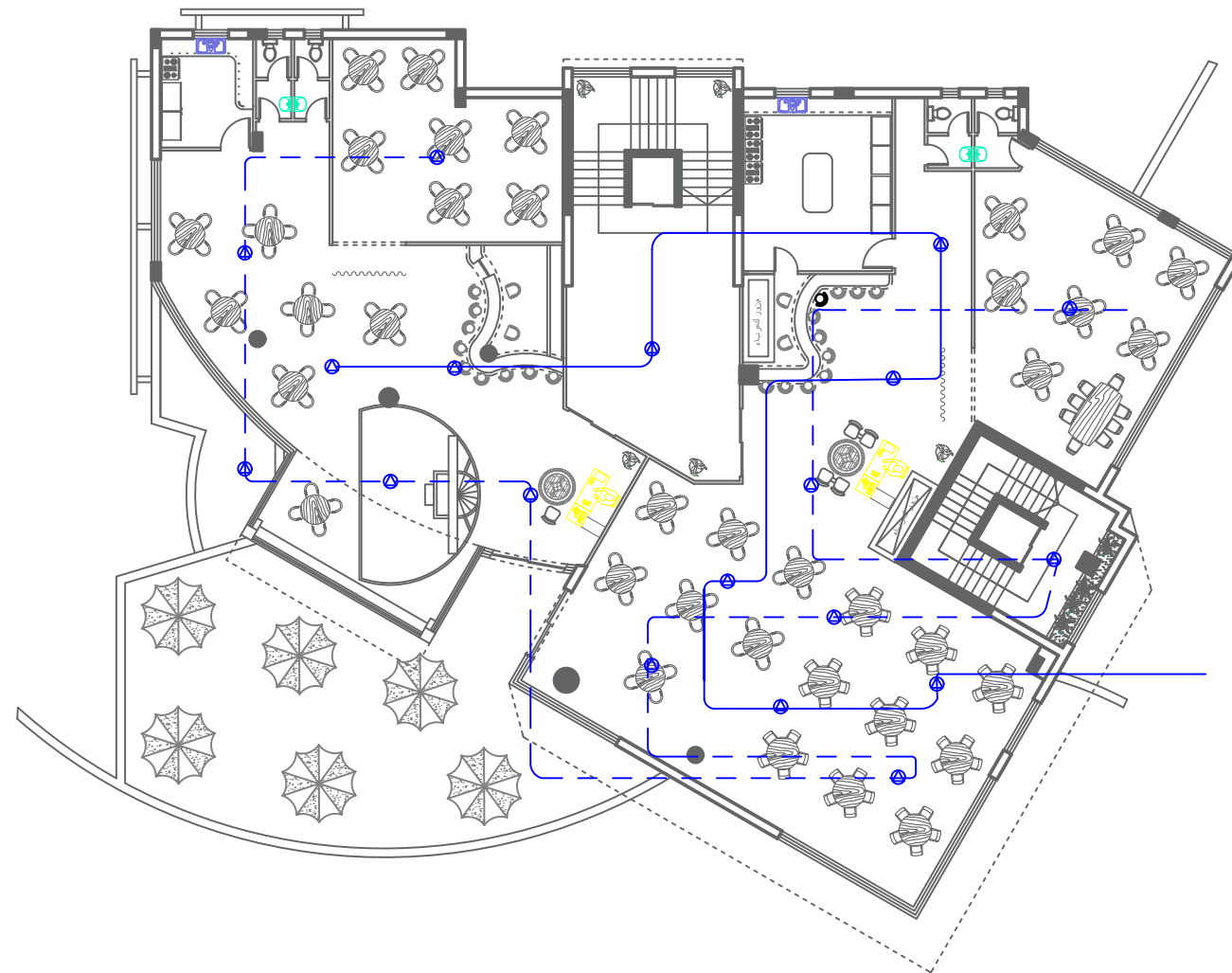

Palestine Polytechnic University
 College of Engineering
 Electrical Department
 Graduation Project

Project name :
 Electrical System, Lighting and
 Supporting Works Design for
 Commercial Mall in Hebron

Drawing Title :
 TE-30

Students Desinger:
 Israa Hasanat
 Marwa abu Muniefe
 Hind Saafin

Supervisor :
 Dr. Fouad Zaro

SCALE	1/100
Sheet Name	4 th - Floor Plan
All Dimensions Are In Meters Unless Otherwise Shown. All Spot Levels Are In Meters.	
DATE: 2021/ 2022	

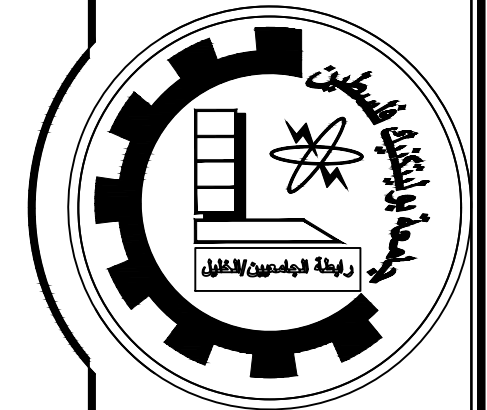
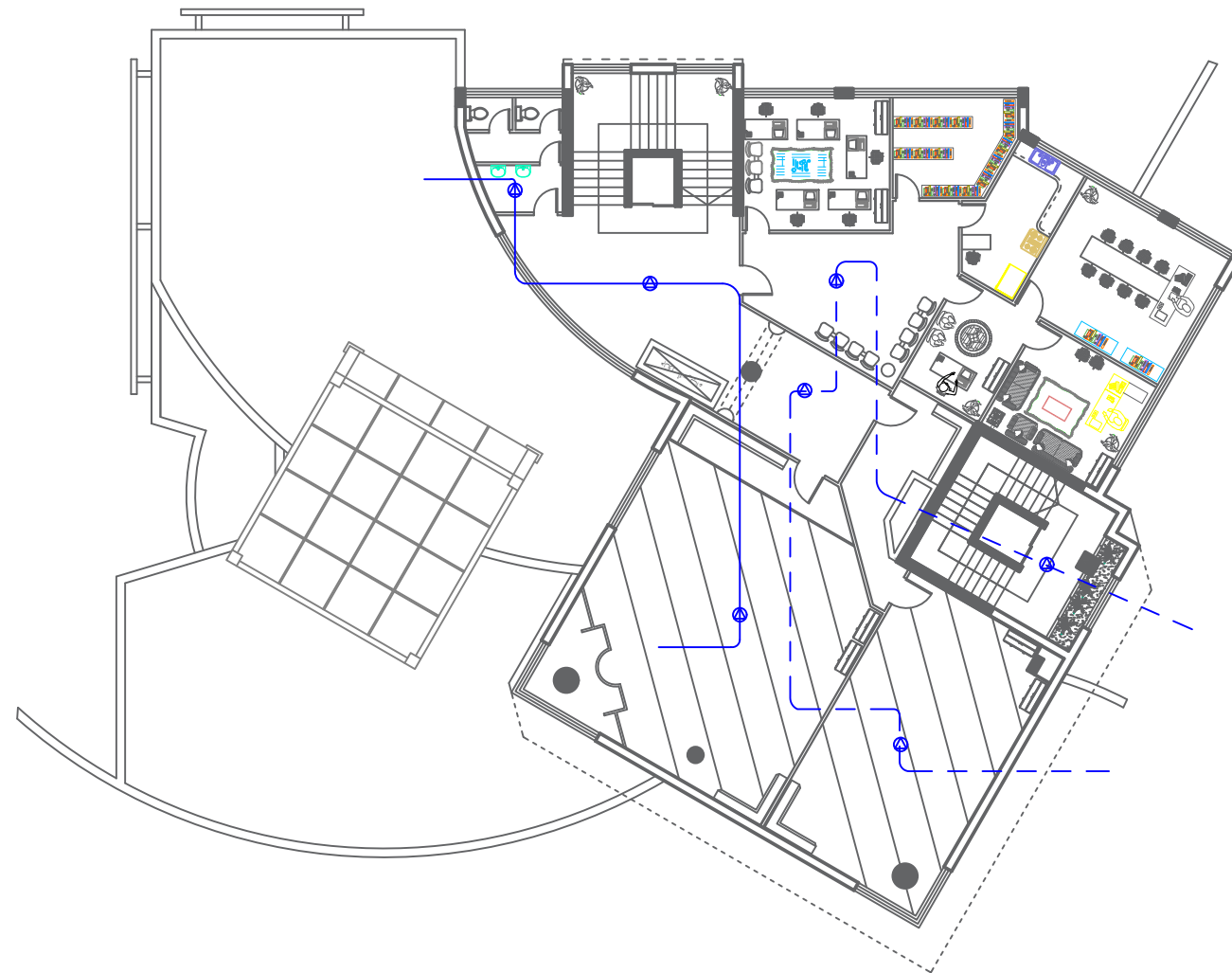

Palestine Polytechnic University
 College of Engineering
 Electrical Department
 Graduation Project

Project name :
 Electrical System, Lighting and
 Supporting Works Design for
 Commercial Mall in Hebron

Drawing Title :
 TE-31

Students Desinger:
 Israa Hasanat
 Marwa abu Muniefe
 Hind Saafin

Supervisor :
 Dr. Fouad Zaro

SCALE	1/100
Sheet Name	5 th - Floor Plan
All Dimensions Are In Meters Unless Otherwise Shown. All Spot Levels Are In Meters.	
DATE: 2021/ 2022	

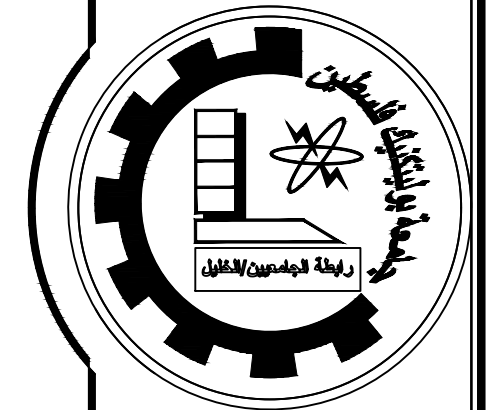
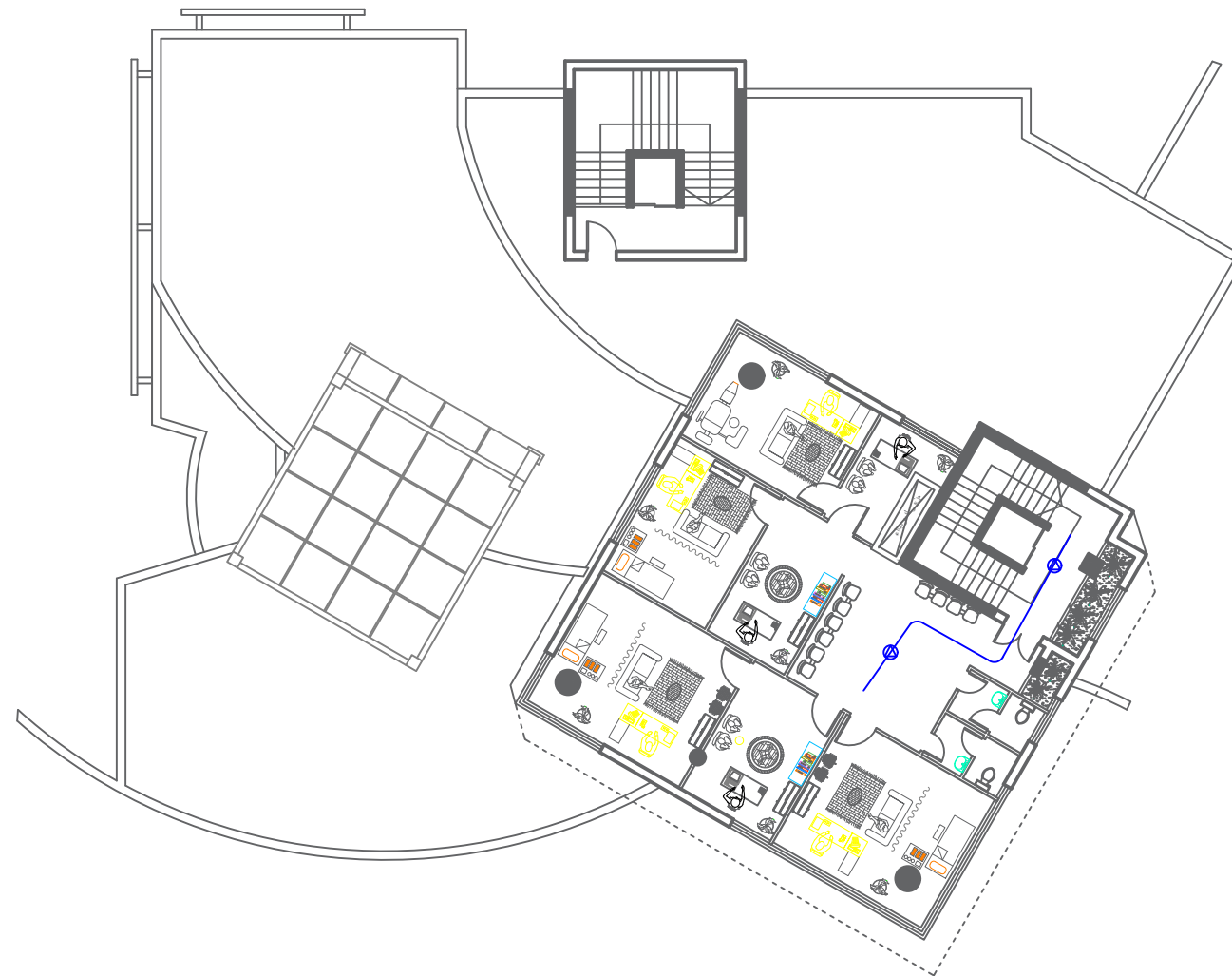

Palestine Polytechnic University
 College of Engineering
 Electrical Department
 Graduation Project

Project name :
 Electrical System, Lighting and
 Supporting Works Design for
 Commercial Mall in Hebron

Drawing Title :
 TE-32

Students Desinger:
 Israa Hasanat
 Marwa abu Muniefe
 Hind Saafin

Supervisor :
 Dr. Fouad Zaro

SCALE	1/100
Sheet Name	6 th - Floor Plan
All Dimensions Are In Meters Unless Otherwise Shown. All Spot Levels Are In Meters.	
DATE: 2021/ 2022	

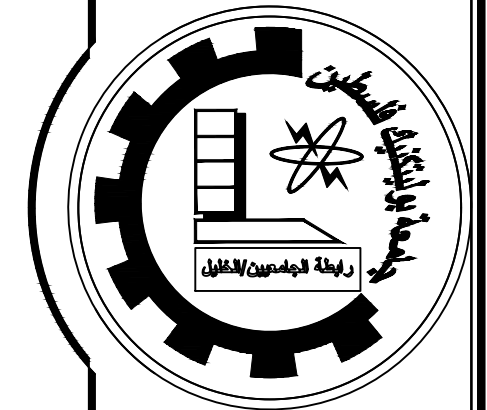

Palestine Polytechnic University
 College of Engineering
 Electrical Department
 Graduation Project

Project name :
 Electrical System, Lighting and
 Supporting Works Design for
 Commercial Mall in Hebron

Drawing Title :
 TE-33

Students Desinger:
 Israa Hasanat
 Marwa abu Muniefe
 Hind Saafin

Supervisor :
 Dr. Fouad Zaro

SCALE	1/100
Sheet Name	7 th - Floor Plan
All Dimensions Are In Meters Unless Otherwise Shown. All Spot Levels Are In Meters.	
DATE: 2021/ 2022	

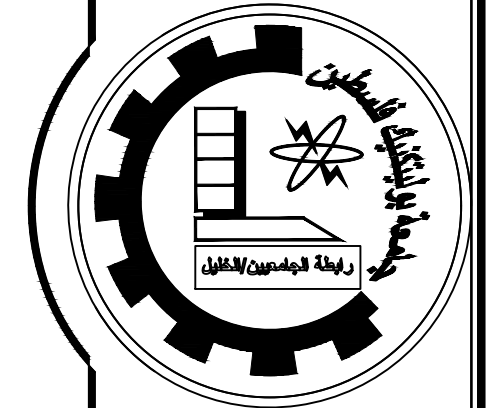
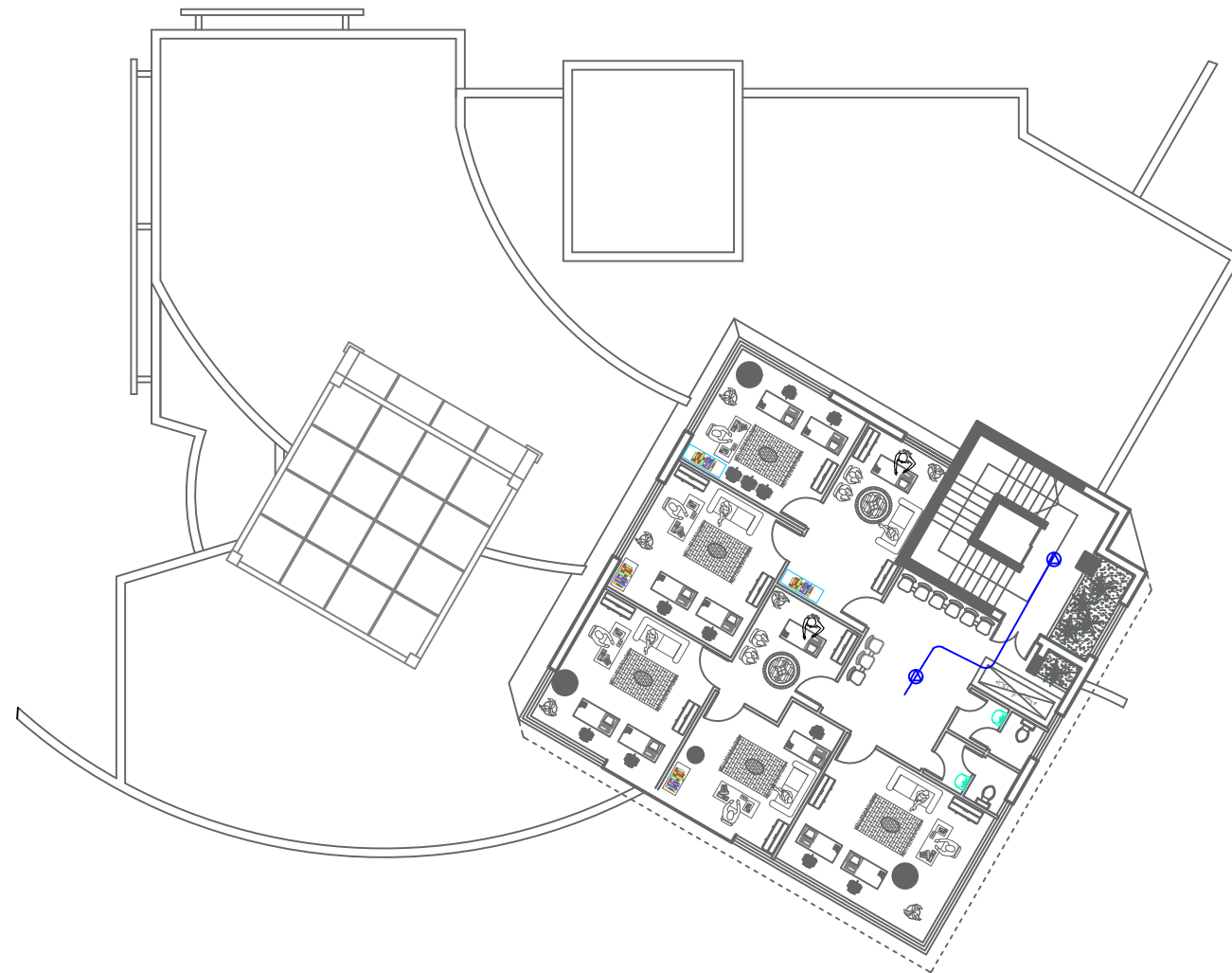

Palestine Polytechnic University
 College of Engineering
 Electrical Department
 Graduation Project

Project name :
 Electrical System, Lighting and
 Supporting Works Design for
 Commercial Mall in Hebron

Drawing Title :
 TE-34

Students Desinger:
 Israa Hasanat
 Marwa abu Muniefe
 Hind Saafin

Supervisor :
 Dr. Fouad Zaro

SCALE	1/100
Sheet Name	8 th - Floor Plan
All Dimensions Are In Meters Unless Otherwise Shown. All Spot Levels Are In Meters.	
DATE: 2021/ 2022	

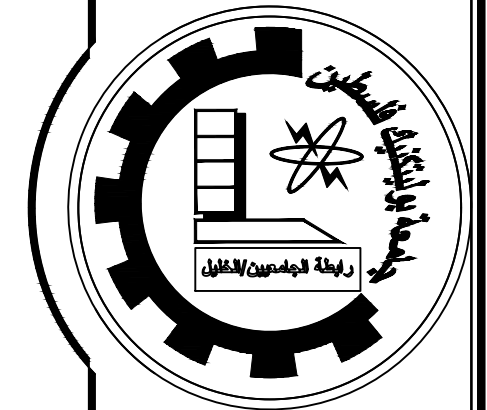
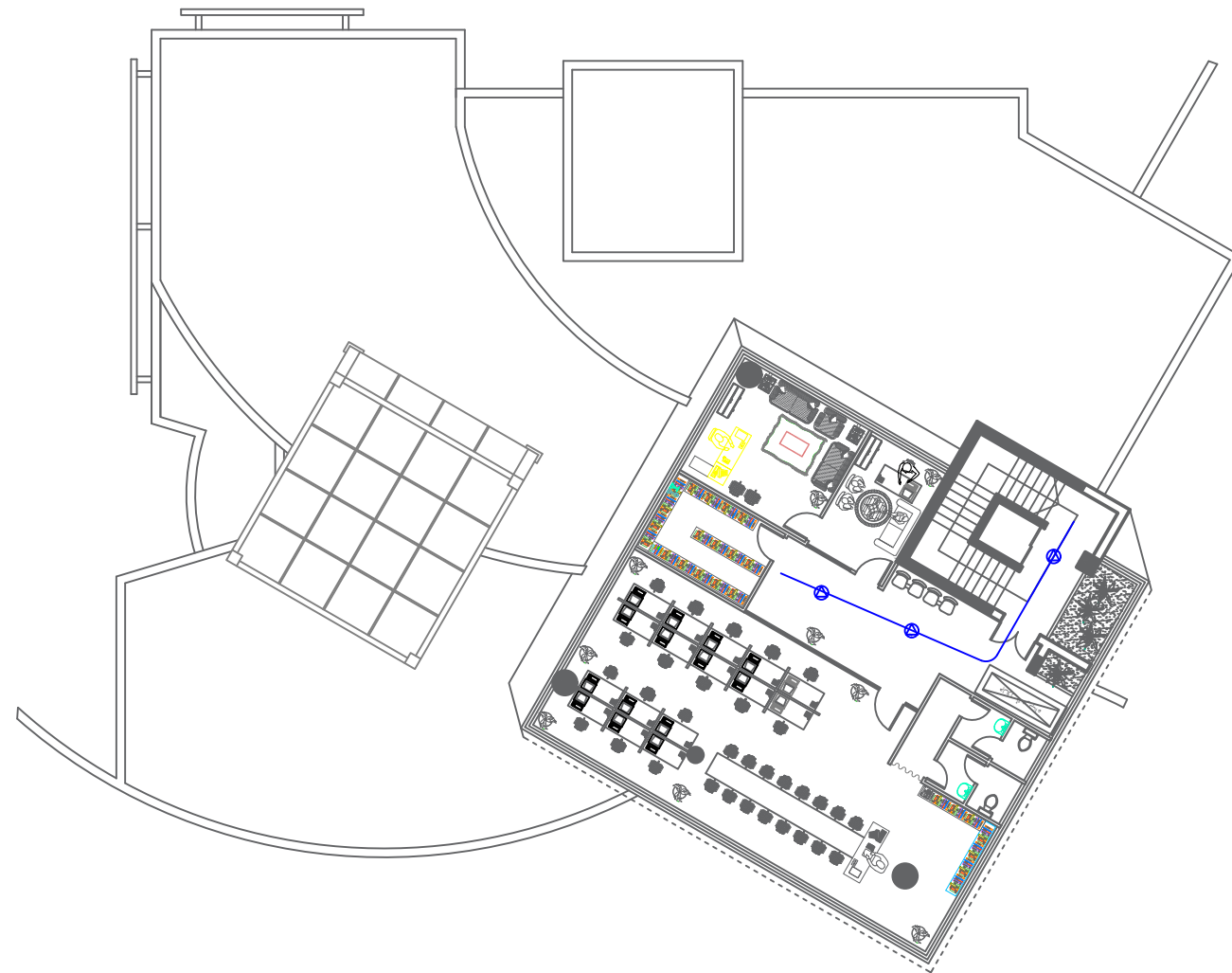

Palestine Polytechnic University
 College of Engineering
 Electrical Department
 Graduation Project

Project name :
 Electrical System, Lighting and
 Supporting Works Design for
 Commercial Mall in Hebron

Drawing Title :
 TE-35

Students Desinger:
 Israa Hasanat
 Marwa abu Muniefe
 Hind Saafin

Supervisor :
 Dr. Fouad Zaro

SCALE	1/100
Sheet Name	9 th - Floor Plan
All Dimensions Are In Meters Unless Otherwise Shown. All Spot Levels Are In Meters.	
DATE: 2021/ 2022	

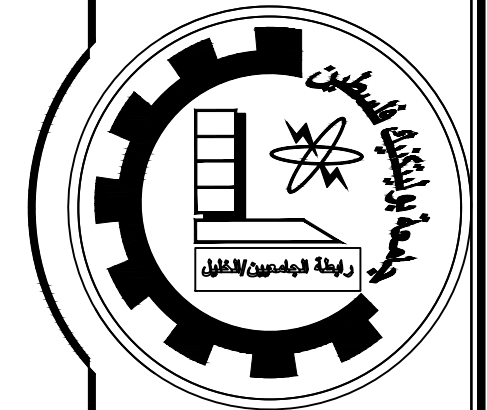

Palestine Polytechnic University
College of Engineering
Electrical Department
Graduation Project

Project name :
Electrical System, Lighting and
Supporting Works Design for
Commercial Mall in Hebron

Drawing Title :
TE-35

Handwritten signature

Students Desinger:
Israa Hasanat
Marwa abu Muniefe
Hind Saafin

Supervisor :
Dr. Fouad Zaro

SCALE	1/100
Sheet Name	9 th - Floor Plan
All Dimensions Are In Meters Unless Otherwise Shown. All Spot Levels Are In Meters.	
DATE: 2021/ 2022	

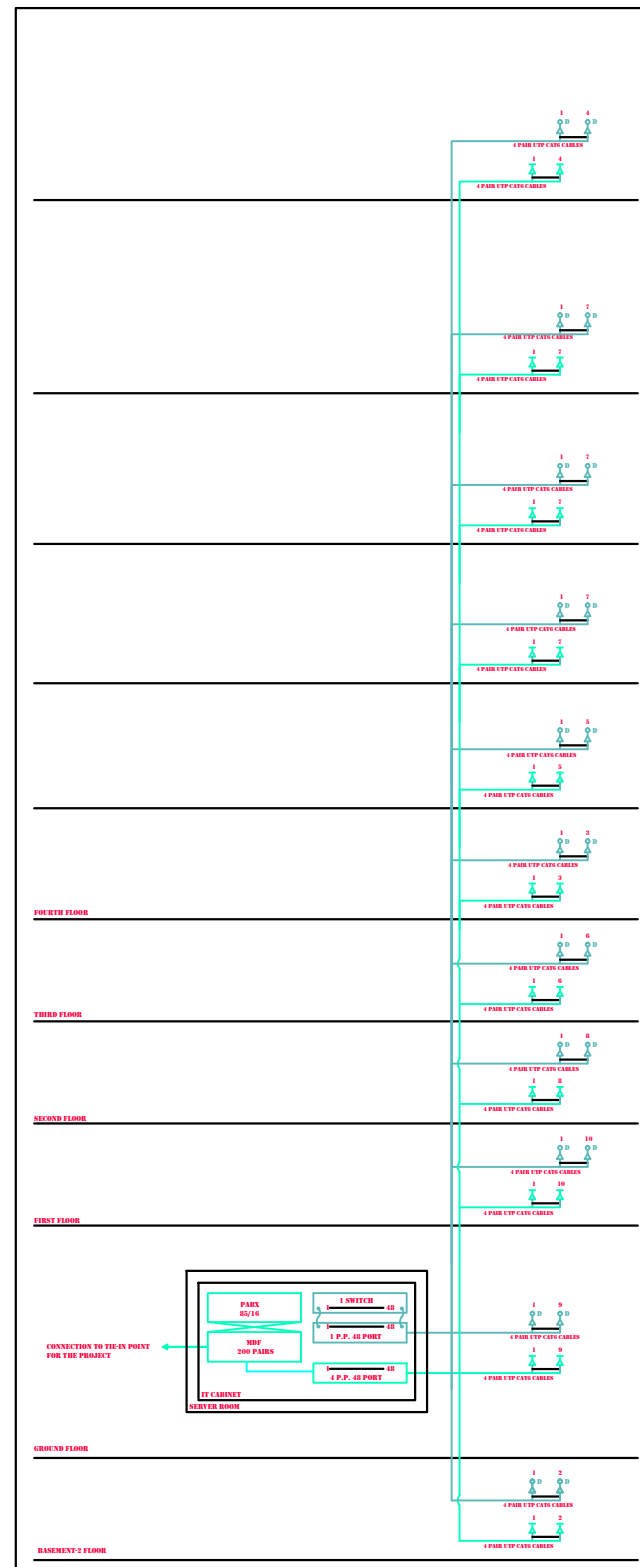

1	2	3	4
5	6	7	8
9	10	11	12
13	14	15	16



1	2	3	4
5	6	7	8
9	10	11	12
13	14	15	16

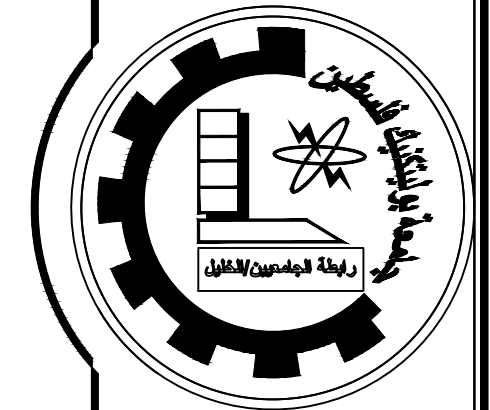
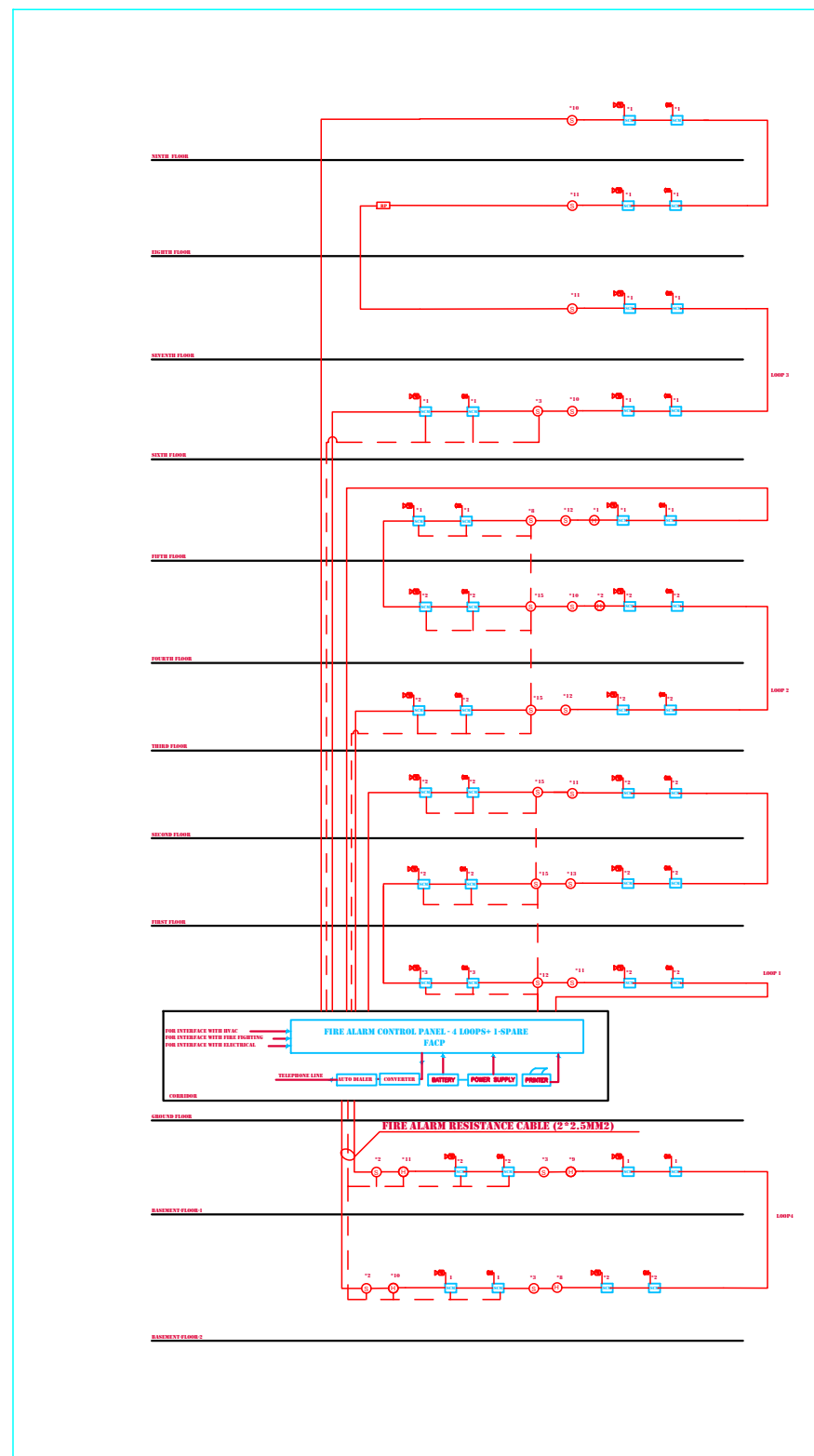
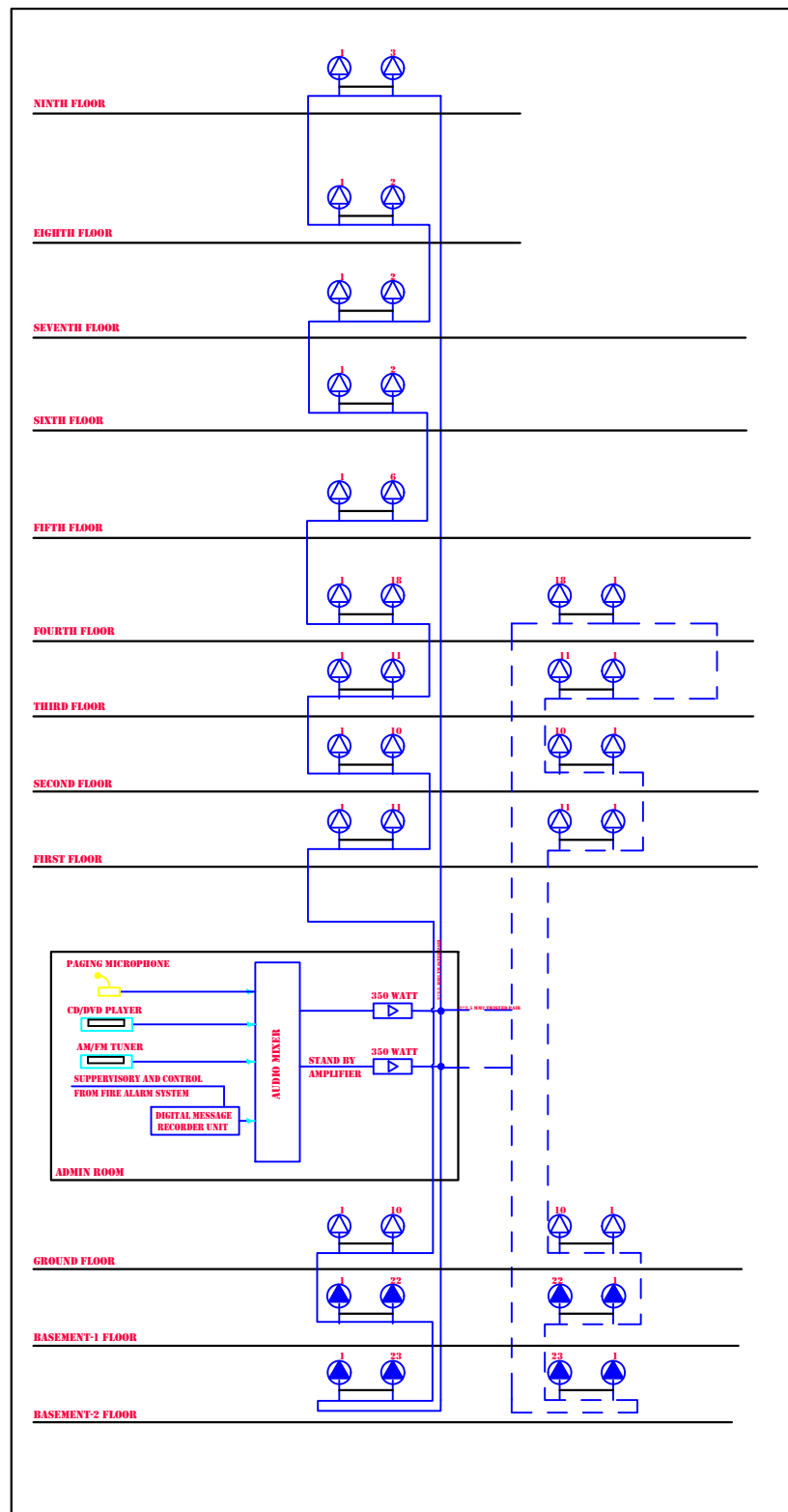

Palestine Polytechnic University
College of Engineering
Electrical Department
Graduation Project

Project name :
Electrical System, Lighting and
Supporting Works Design for
Commercial Mall in Hebron

Drawing Title :
TE-36

Handwritten signature

Students Desinger:
Israa Hasanat
Marwa abu Muniefe
Hind Saafin

Supervisor :
Dr. Fouad Zaro

SCALE	1/100
Sheet Name	9 th - Floor Plan
All Dimensions Are In Meters Unless Otherwise Shown. All Spot Levels Are In Meters.	
DATE: 2021/ 2022	