

بسم الله الرحمن الرحيم

Palestine Polytechnic University



**College of Engineering & Technology
Mechanical Engineering Department**

Rehabilitation of juice filling machine at 'Al-Sharif factory'

Project Team:

Firas Siouri

Mohammad Majde Zalloum

Project Supervisor

Eng. Zuheir Wazwaz

Submitted to the College of Engineering
In partial fulfillment of the requirements for the degree of
Bachelor degree in Mechatronics Engineering

Hebron-Palestine

2020

الأهداء

أيام مضت من عمرنا بدأناها بخطوة وها نحن اليوم نقطف ثمار مسيرة أعوام كان هدفنا فيها واضحا وكنا نسعى في كل يوم لتحقيقه والوصول له مهما كان صعبا وها نحن اليوم نقف أمامكم وها نحن وصلنا وبيدينا شعلة علم وسنحرص كل الحرص عليها حتى لا تنطفئ ونشكر الله أولا وأخير على أن وفقنا وساعدنا على ذلك
ثم نتقدم بالشكر إلى القلب الحنون من كانت بجانبنا بكل المراحل التي مضت من تلذذت بالمعاناه وكانت شمعه تحترق لتنتير
دربنا

....إلى أمهاتنا الحبيبات

وإلى من علمنا أن نقف وكيف نبدأ الألف ميل بخطوة إلى يدنا اليمنى إلى من علمنا الصعود وعيناه تراقبنا....
....إلى والدنا

لمن كان يتحملنا بأخطائنا وكانوا عوننا لنا
....إلى أخوتنا وأخواتنا

لمن أمسك بيدينا وعلمنا حرفا.. حرفا.. سنهدي له نجاحنا اليوم إلى من كانوا سندنا لنا إلى من لهم الفضل بإرشادنا إلى طريق
العلم والمعرفة
....إلى أساتذتنا الأفاضل

من سهرنا معنا في مسيرتنا العلمية إلى من مدوا أياديهم البيضاء في ظلام الليل وكانوا أنس لنا في طريقنا الشاق و عوننا لنا ،
أيام جميله قضيناها نعيشها الآن لحظة...بلحظة ونشعر وكأنها شريط يمر بمخيلتنا من جديد عام.. وعام يوما...ويوم
....إلى أصدقائنا وزملائنا

ولن ننسى هذا المكان الذي جمعنا بمقاعده وأبوابه حتى فنائه إلى كل جزء به...
....إلى جامعتنا العريقة جامعة بوليتكنك فلسطين

ولن ننسى وطننا المعيق بأريج الحب لن ننساه وسنقدم كل ما بوسعنا له وسنجعل كل ركن به يشهد بما سنقدم وسنكون كالمطر
ولن نبخل بما تعلمنا وسنكون كالماء أينما وقعنا نفعنا
....إلى وطننا الحبيب فلسطين
إلى اسرانا وشهداؤنا والقدس الشريف.

نشكركم بكل ماتحمله كلمة شكر من معنى ونهدي لكم كل عمرنا يا أجمل ماضى به
نشكركم تنطقها قلوبنا على ألسنتنا نشكركم كلمة تعني لنا الكثير وتحمل من الشعور الكثير
تخوننا كل عبارات الشكر في تقديم مايليق بكم لن ننسى الفضل ولن ننساكم أبدا

الملخص

تعمل الماكينة على تعبئة ثمان عبوات اوتوماتيكيا في نفس الوقت , من خلال نقل العصير من الخزان الى علب التحجيم, ثم يتم تعبئته في عبوات عن طريق بستونات هواء.

المشكلة الرئيسية في هذه الماكينة هي تشكل الرغوة خلال عملية التعبئة, مما يؤدي الى خروج العصير من العبوة, وينتج عن هذا اختلاف مستوى العصير بالعبوات.

لحل مشكلة الماكينة سيتم التعبئة عن طريق الجاذبية الأرضية واستخدام مجسات لتحديد مستوى العصير في العبوة.

Abstract

The purpose of the machine is to fill eight bottles of juice automatically at the same time, by moving juice from the tank to sizing containers, then the juice is filled into the bottles by pneumatic cylinders.

The main problem of this machine is that foam is produced during the filling process, which leads the juice to flow out of the bottles. As a result, the juice level in the bottles are different.

This problem can be solved by filling the juice by gravity and use sensors to determine the juice level in the bottles.

List of Contents

- Abstract I
- List of Contents III
- List of Figures V
- List of Tables VII
- Chapter One: Introduction 1**
 - 1.1 Machine working principle: 2
 - 1.2 The problem from the company’s point of view 3
 - 1.3 Problem definition..... 3
 - 1.4 Goals and objectives..... 4
 - 1.5 Full description of the machine.....4
 - 1.6 Evaluating our options to improve the production process9
- Chapter Two: Literature Review..... 10**
 - 2.1 About juice..... 11
 - 2.2 About liquid filling machine..... 11
 - 2.3 Processing of fruit juice12
 - 2.4 The problem of filling the bottle manually.....12
 - 2.5 Design and development of automated bottle filling system.....12
- Chapter Three: Power 14**
 - 3.1 Electrical power 16
 - 3.1.1 Machine operating power 16
 - 3.1.2 Power circuit symbols 17
 - 3.1.3 Motor connection 18
 - 3.1.4 PLC and the power supply connection 19
 - 3.1.5 Wires numbering 19
 - 3.1.6 Motor nameplate 19
 - 3.1.7 Star connection (Y)..... 19
 - 3.2 Pneumatic power 22

3.2.1 Pneumatic circuit symbols	25
Chapter Four: Control	26
4.1 PLC	27
4.1.1 Programming	28
4.1.2 How the PLC works in the machine	29
4.1.3 Control circuit	30
4.1.4 Control circuit symbols	31
4.1.5 The flowchart of PLC programming	33
4.2 HMI	34
4.2.1 Why touch screen	35
4.2.2 Touch screen programming	35
Chapter Five: Solutions	38
5.1 How the machine operated right before it was fixed	39
5.2 Suggested solutions	39
5.2.1 Suggested solutions for the foam problem	39
5.2.2 Suggested solutions for the level problem	41
5.2.3 Suggested solutions for the Machine is not working	42
5.3 Practical experiments	43
5.4 Proximity sensor	45
Chapter Six: Conclusion and Recommendations	46
6.1 Conclusion	47
6.2 Recommendations.....	48
Reference.....	49

List of Figures

Figure 1.1 Juice filling machine 2

Figure 1.2 Tank and stopcock 4

Figure 1.3 directional control valve, sizing containers and pipes 5

Figure 1.4 Entrance gate sensor 6

Figure 1.5 Sizing containers and pneumatic cylinder 6

Figure 1.6 Pipes, nozzles and pneumatic cylinders 7

Figure 1.7 Pneumatic cylinders that are connected to sizing containers 8

Figure 1.8 End gate sensor 8

Figure 2.1 Design of automated bottle filling system 13

Figure 3.1 power circuit of the machine 17

Figure 3.2 Motor nameplate 19

Figure 3.3 Connect the motor “star connection” 19

Figure 3.4 Star connection 20

Figure 3.5 Electrical panel of the machine 21

Figure 3.6 Solenoid connected with 5/2 way valve 22

Figure 3.7 Relays and solenoids connected to the power supply 22

Figure 3.8 Pneumatic circuit 24

Figure 3.9 Pnuematic panel of the machine 25

Figure 4.1 PLC-Delta 27

Figure 4.2 difference between sink and source circuit 30

Figure 4.3 Control circuit of the machine 30

Figure 4.4 HMI Weinview 35

Figure 4.5 The main page for the touch screen program 36

Figure 4.6 The automatic control of the machine using the touch screen 36

Figure 4.7 The manual control of the machine using the touch screen 37

Figure 4.8 Machine input status on the touch screen 37

Figure 4.9 Machine output status on the touch screen	38
Figure 5.1 Practical experiments filling the juice through gravity	43
Figure 5.2 Practical experiments of determining the filling level	44
Figure 5.3 Level sensor specifications	45

List of Tables

Table 1.1 Advantages and disadvantages of buying a new machine, fix the machine and keep the machine, unfixed. 9

Table 3.1 Power circuit symbols 18

Table 3.2 Relays and solenoids circuit symbols 23

Table 3.3 Pneumatic circuit symbols 25

Table 4.1 Control circuit symbols 31

1

Introduction

Introduction

Juice filling machine in Al-Sharif factory used to fill eight bottles at the same time which sizes three liters, the machine consists of a tank “filled with juice”, sizing containers, directional control valve, pneumatic cylinders, and nozzles, a picture of the machine is shown in figure 1.1.



Figure 1.1 Juice filling machine.

1.1 Machine working principle

After preparing the juice which has a temperature of 50°C filled in the tank, then directional control valve open sizing containers to fill it with juice which goes through the pipes, The worker on the machine put the bottles on the conveyor manually “by hand” then the conveyor moves the bottles to the machine, at the entrance there is a proximity sensor that counts eight bottles to close the entrance gate using pneumatic cylinder, the end gate already closed, after the sizing containers filled with juice the level sensor indicate the juice level and the proximity sensor at the entrance counts eight bottles then give signal to switch the directional control valve, by using pneumatic cylinders move the juice through pipes from the sizing containers to the pneumatic cylinder that are connected to nozzles to fill the bottles, a limit switch placed at the end of sizing containers

that are connected to pneumatic cylinder, when the sizing containers that are connected to pneumatic cylinders hit the limit switch, pneumatic cylinder close the nozzle, sizing containers return to its initial position and the directional control valve switch to fill the sizing container, the end gate open to move the filled bottles out, using proximity sensor to count eight bottles that filled then the end gate close and the entrance gate open to put bottles again.

1.2 The problem from the company's point of view

The first problem:- during filling the juice a foam is produced in the bottle, and this cause rising up the juice level in the bottles, and because of that the juice overflow form the bottles.

The second problem: - when filling the juice in the bottles, some of these bottles have a lower level than other bottles.

1.3 Problem definition:

1- Foam problem:

The first issue: - The machine was manufactured to fill liquids and tested on water; however, Al-Sharif factory used it as a juice filling machine. The viscosity of juice is higher than water, so this created a foaming problem.

The second issue: - Pneumatic cylinders pushes the juice from the sizing container by a big force that produces a high flow in the pipe. This leads to foam appearing and some of the juice might leak out of the bottle.

2- Level Problem:

As discussed above, foaming leads to juice being leaked out of the bottle. In addition, bottles will have different juice levels. With sizing containers being fully closed and therefore extremely difficult to reach and clean, some of the juice gets stuck inside them. This leads to the production of uneven juice level in the bottles.

3- The machine is not working:

Before ten years, the factory decided to stop work on the machine because of the foam's problem and level problem, and now after ten years the machine not working, it became a scrap now.

1.4 Goals and objectives

Bring the machine back to work and solve the produced foam during filling and the level problem.

1.5 Full description of the machine

After preparing the juice which has a temperature of 50°C filled in the tank, then manually open the stopcock to move the juice through the pipe to sizing containers as shown in figure 1.2.



Figure 1.2 Tank and stopcock.

Using a level sensor in the sizing containers indicates the juice level and when they are empty the directional control valve open to fill the juice in the sizing containers as shown in figure 1.3.



Figure 1.3 directional control valve, sizing containers and pipes.

Then after a level sensor indicate the juice inside sizing containers are full and a proximity sensor at the entrance of the conveyer counts eight bottles as shown in figure 1.4, the entrance gate closed by pneumatic cylinder, then the directional control valve switch to close the way from tank to sizing containers and open the way from sizing containers to the pneumatic cylinders with nozzle as shown in figure 1.5.



Figure 1.4 Entrance gate sensor.



Figure 1.5 Sizing containers and pneumatic cylinder.

By pneumatic cylinder move the juice through pipes from sizing containers to pneumatic cylinders that are connected to the nozzle to fill the bottles as shown in figure 1.5 and figure 1.6.



Figure 1.6 Pipes, nozzles and pneumatic cylinders.

a limit switch placed at the end of sizing containers that are connected to the pneumatic cylinders, when the pneumatic cylinders hit the limit switch, pneumatic cylinder close the nozzle, sizing containers return to its initial position and the directional control valve switch to fill the sizing container as shown in figure 1.6 and figure 1.7.



Figure 1.7 Pneumatic cylinders that are connected to sizing containers.

After filling the bottles the end gate opens by pneumatic cylinder, the proximity sensor counts eight bottles then closed and open the entrance gate as shown in figure 1.8.



Figure 1.8 End gate sensor.

1.6 Evaluating our options to improve the production process

In order to improve with the production process, we have the option of keeping the old machine or purchasing a new one. However, if we decide on keeping the old machine, it would be much more convenient to fix it. In the table below, we state the advantages and disadvantages of each of our options.

Options	Advantages	Disadvantages
Buy a new machine	<ol style="list-style-type: none"> 1. Requires a little maintenance 2. Comes with manufacturer insurance. 3. Uses the latest technologies. 4. Low power cost. 	<ol style="list-style-type: none"> 1. Expensive (Up to \$10,000) 2. Production down time until the new machine arrives and installed 3. Requires experts to install and maintain
Keep the machine, unfixed.	Sell each part individually	<ol style="list-style-type: none"> 1. Requires many workers to operate manually 2. Low production. 3. Low efficiency and work precision. 4. Machines losses value 5. The machine occupies a large area in the factory
Fix the machine	<ol style="list-style-type: none"> 1. Saves on purchasing a new machine 2. Get it back up and running 3. Fix the foam problem. 4. Fix the leveling problem. 5. Increase productivity compared to manual production. 6. Increase efficiency and work precision. 7. Requires fewer workers to operate. 	<ol style="list-style-type: none"> 1. Requires new parts, which could be expensive for some. 2. Requires time to fix.

Table 1.1 Advantages and disadvantages of buying a new machine, fix the machine and keep the machine, unfixed.

2

Literature Review

Introduction

2.1 About juice

In a previous study in the United States about the consumption of juice in 2000, the consumption accounted for 44% of total fruit consumption, and this percentage is expected to increase in the future. Orange juice is the most popular of the juice products accounting for 60% of all juice consumed, although orange and grape juice is considered to be the more traditional fruit juices, fruit juice blends of traditional and nontraditional fruits and fruit drinks contribute significantly to the fruit juice market and have received wide consumer acceptance.[1]

Fruit and vegetable juices have a long history of regulation in the United States. Early in the late 19th and early 20th centuries, juices were often indirectly regulated by import tariffs, which taxed juice products in different ways. Most domestic juices were sold fresh, and there was little need for further regulation until the invention of refrigeration. The first national regulations came in the form of informal standards of identity for each juice. [3]

2.2 About liquid filling machine

The liquid filling machine is used in the beverage and bottling industries. Some of the filling machines are commercialized as water or juice vending machine. The machine found in the market is high in price, requires complex changes in hardware and program configuration if the varied liquid volume is required to be filled and most of the time it is not fully automatic. [4]

2.3 Processing of fruit juice

Raw material selection is critical to the quality of the final product. The intensity of the aroma quality of the fruit prior to processing has a significant impact on the overall aroma and taste of the juice. Cultivars and maturity of the fruit have a significant impact on the quality of the final products. Other factors, such as ethylene and respiration rates, climate, soil, and fertilization can also contribute to variations in the volatile flavor compounds in the fruits. Extraction of the juice from the fruits through pressing is the initial step in juice processing. Depending on the nature of the final product, the extracted juice may undergo pasteurization, concentration, and packaging treatments that have a significant impact on the flavor quality of the processed fruit juice. [2]

2.4 The problem of filling the bottle manually

In some industries, the bottle filling operation is done manually. The manual filling process has many shortcomings like spilling of liquid while filling it in a bottle, an equal quantity of liquid may not be filled, and natural human activities have an impact on filling manually. The problem solved through manufacture automated filling machines. [4]

2.5 Design and development of automated bottle filling system

The bottle filling machine system is controlled by the microcontroller. Figure 2.1 gives the components of the bottle filling machine system controlled by the Arduino based on Microcontroller. When the bottle is put on the conveyor the servo motor will start to move it through the conveyor to the nozzle when the sensor senses the bottle under the nozzle it will stop the servo motor, then the solenoid valve will open to moving the liquid from the tank to the bottle, the flow meter measures the liquid that is put in the bottle when the bottle is filled, the solenoid will be closed and the servo motor will start again to move the bottle to the next level through the conveyor as shown in figure 2.1.[4]

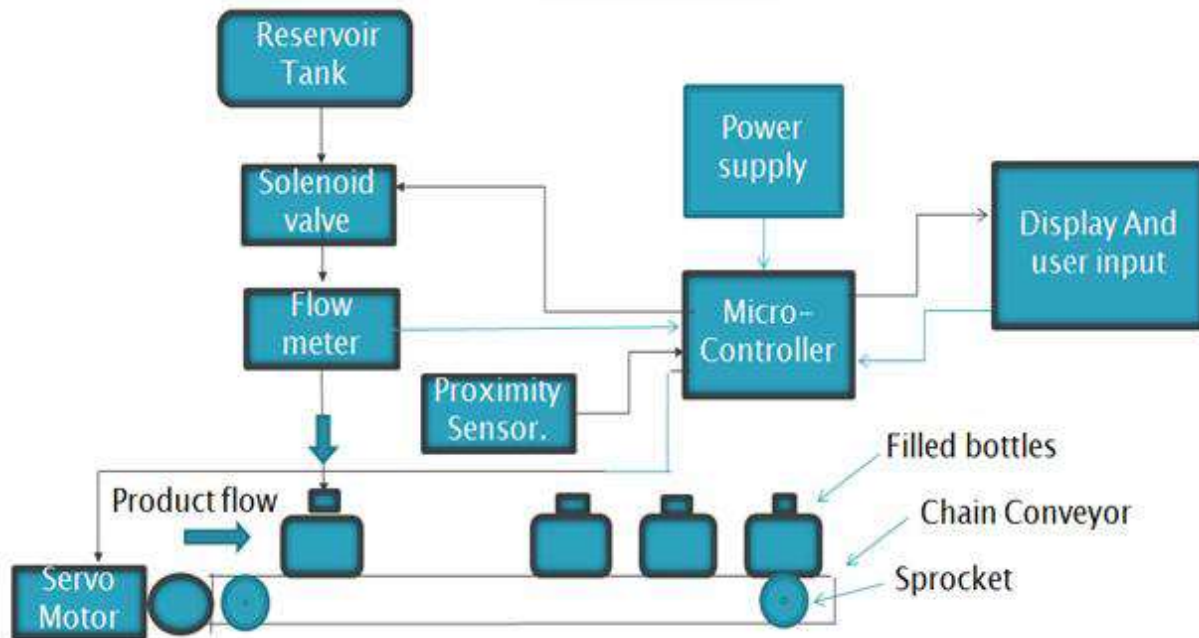

Figure 2.1 Design of automated bottle filling system.

3

Power

Introduction

What is power “Electric Power”?

In physics, power is the amount of energy transferred per unit time. In the International System of Units, the unit of power is the watt.

What is energy?

In physics, the capacity for doing work. It may exist in potential, kinetic, thermal, and electrical, or other various forms.

AC electric power

Single-phase electric power:-

Single-phase electric power is the distribution of alternating current, it is the most efficient AC power supply for low-power loads, such as lighting and heating, with few large electric motors. A single-phase supply connected to an alternating current electric motor does not produce a rotating magnetic field; single-phase motors need additional circuits for starting, and such motors are uncommon above 10 kW in rating. The system provides a voltage of 220V.

Three-phase electric power:-

A multi-phase electrical system for alternating current is used, and most common in power plants that produce electricity. It was called a three-phase because the current are going in three wires, and each current of these three begins with a phase of displacement of the other by 120 degrees. This system is the most widespread in the operation of electric motors that operate at high capacity in factories and vehicles. The system provides a voltage of 380V.

DC electric power:

It is a steady flow of electrons from a high-voltage region to another with a lower voltage and is generated from electric batteries, solar cells, and the electrical exchanger used in electrical machines. And it is usually transmitted in metals such as electrical wires, and the electric charge flows in the case of direct current in the same direction, and thus it differs from alternating current. The constant current can be obtained from alternating current things called a uniform which consists of electronic elements.

- **Objectives of this chapter**

In this chapter, we will explain the machine operating power using the terms discussed above

3.1 Electrical power

3.1.1 Machine operating power

In the machine, there are loads that operate on single-phase and these loads are PLC and the Power supply. On the other hand, the motor operates in three-phase.

To clarify, we drew the power circuit of this machine as shown in figure 3.1.

And table3.1. To explain the electrical symbols and their uses in the circle.

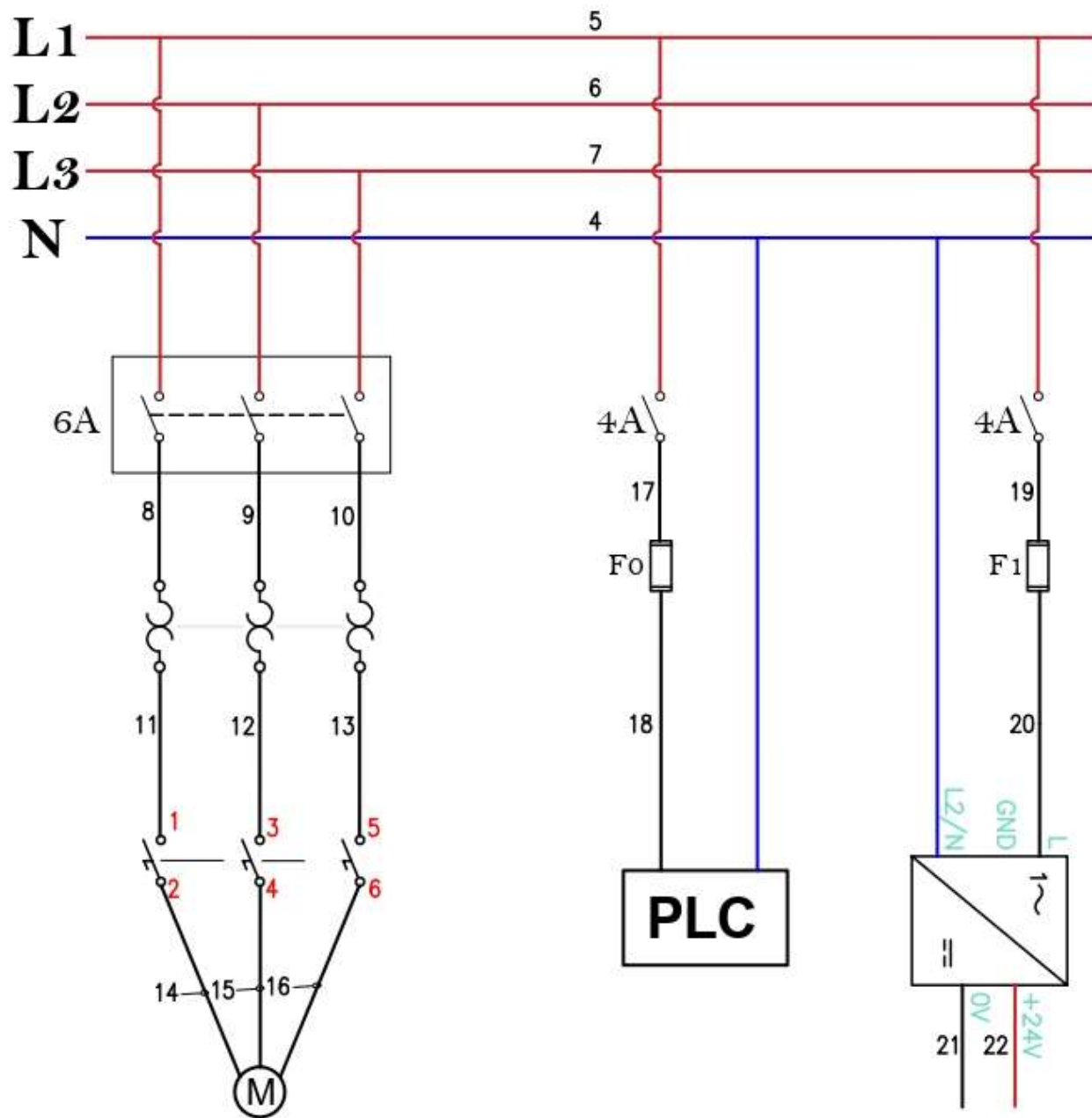

Figure 3.1 power circuit of the machine

3.1.2 Power circuit symbols



Name	Symbols	Quantity	Uses
3-phase main circuit breaker		1	Protect from overcurrent it can stand up to “maximum current” 6 Amber
3-phase overload		1	Protect the motor from overcurrent
3-phase contactor		1	Magnetic switch Use to start working the motor
Single-phase Circuit breaker		2	Protect from overcurrent it can stand up to “maximum current” 4 Amber
Fuse		2 “F0,F1”	Protect PLC from overcurrent
Power Supply		1	Convert 220 volt AC to 24 volt DC
Red wire			Positive voltage wire
Black wire			Zero voltage wire and Connections between parts
Blue wire			Neutral wire

Table 3.1 Power circuit symbols.

3.1.3 Motor connection

A single wire was connected from each single-phase (L1, L2, and L3) to the 3-phase main circuit breaker after that 3-phase main circuit breaker is connected to 3-phase overload then from overload to the 3-phase contactor then to the 3-phase motor.

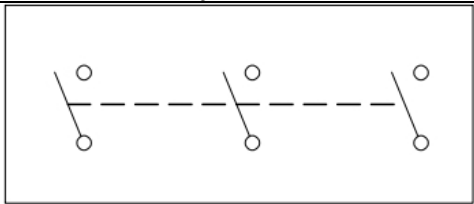
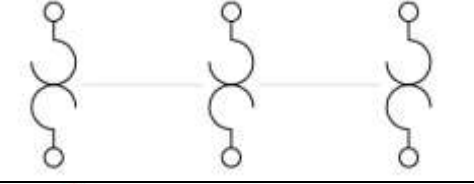
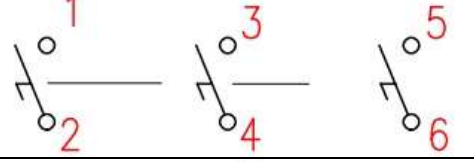
3.1.4 PLC and the power supply connection

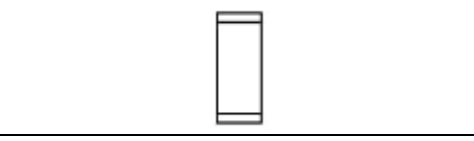
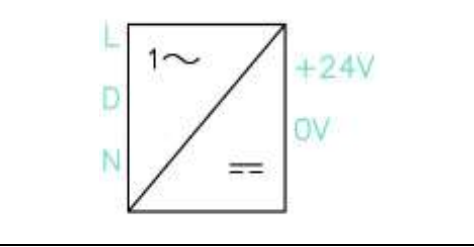
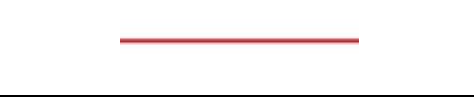
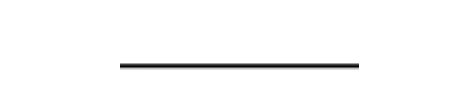
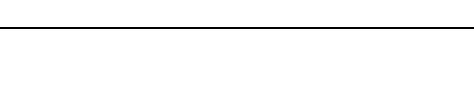
A wire was connected from L1 to the single-phase main circuit breaker after that, it connected to the fuse, and then to the PLC in addition, the PLC is connected to a neutral line. The same connection is being followed by the power supply.

3.1.5 Wires numbering

The numbers (4-22) shown in figure 3.1 are considered names for each wire. These numbers are important for the following reasons

- 1- Makes testing easier and troubleshoots and resolves issues during circuit design and execution. Engineers can troubleshoot and resolve issues without having to go back to Electrical schemes.
- 2- Makes replacing or adding additional wire easier.

3.1.6 Motor nameplate



Figure 3.2 Motor nameplate.

As shown in the nameplate in figure 3.2 above, we connected 3 phase motor in star connection as shown in figure 3.3

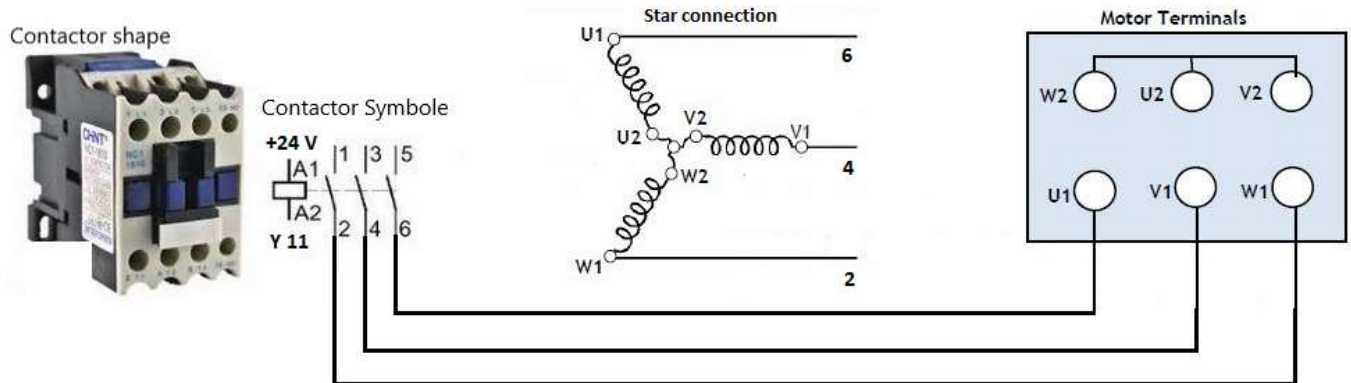

Figure 3.3 Connect the motor “star connection”.

3.1.7 Star connection (Y)

Star Connection is the most preferred system for AC power distribution while for transmission, is obtained by connecting together similar ends of the three coils, The common point is called the neutral or Star Point, which is represented by N as shown in figure 3.4.

Star Connection specifications

- 1- A star connection is a 4– wire connection (4th wire is optional in some cases). Out of the 4 wires, 3 wires are the phases and 1 wire is the neutral (which is the common point of the 3 wires).
- 2- In a star connection, one end of all the three wires are connected to a common point in the shape of Y, such that all the three open ends of the three wires from the three phases and the common point forms the neutral.
- 3- Line voltage (voltage between any two phases) and phase voltage (voltage between any of the phases and neutral) is different.
- 4- Line current and phase current are the same.
- 5- Star connections are often used in an application which requires less starting current.

In our case, the motor has 3 wires connected to three-phase without neutral and we connected in a star connection in order to have a low starting current.

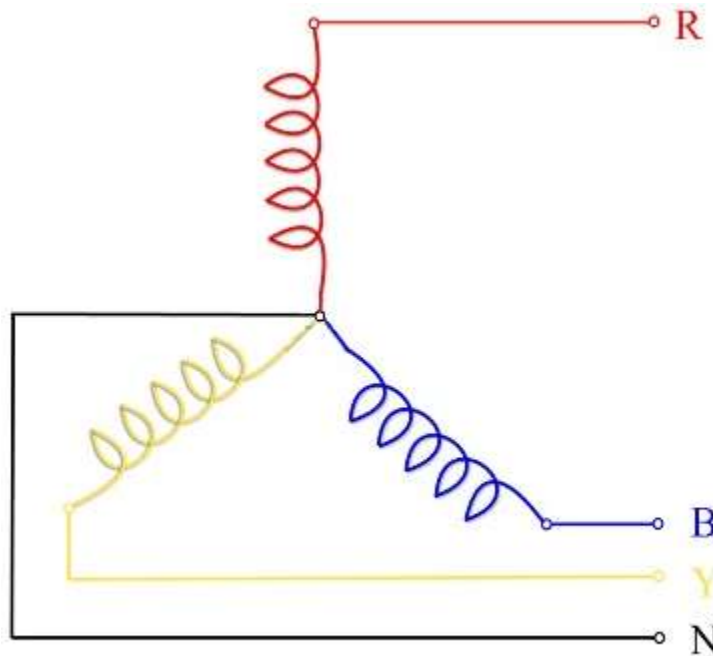

Star Connection (Y or WYE)

Figure 3.4 Star connection.

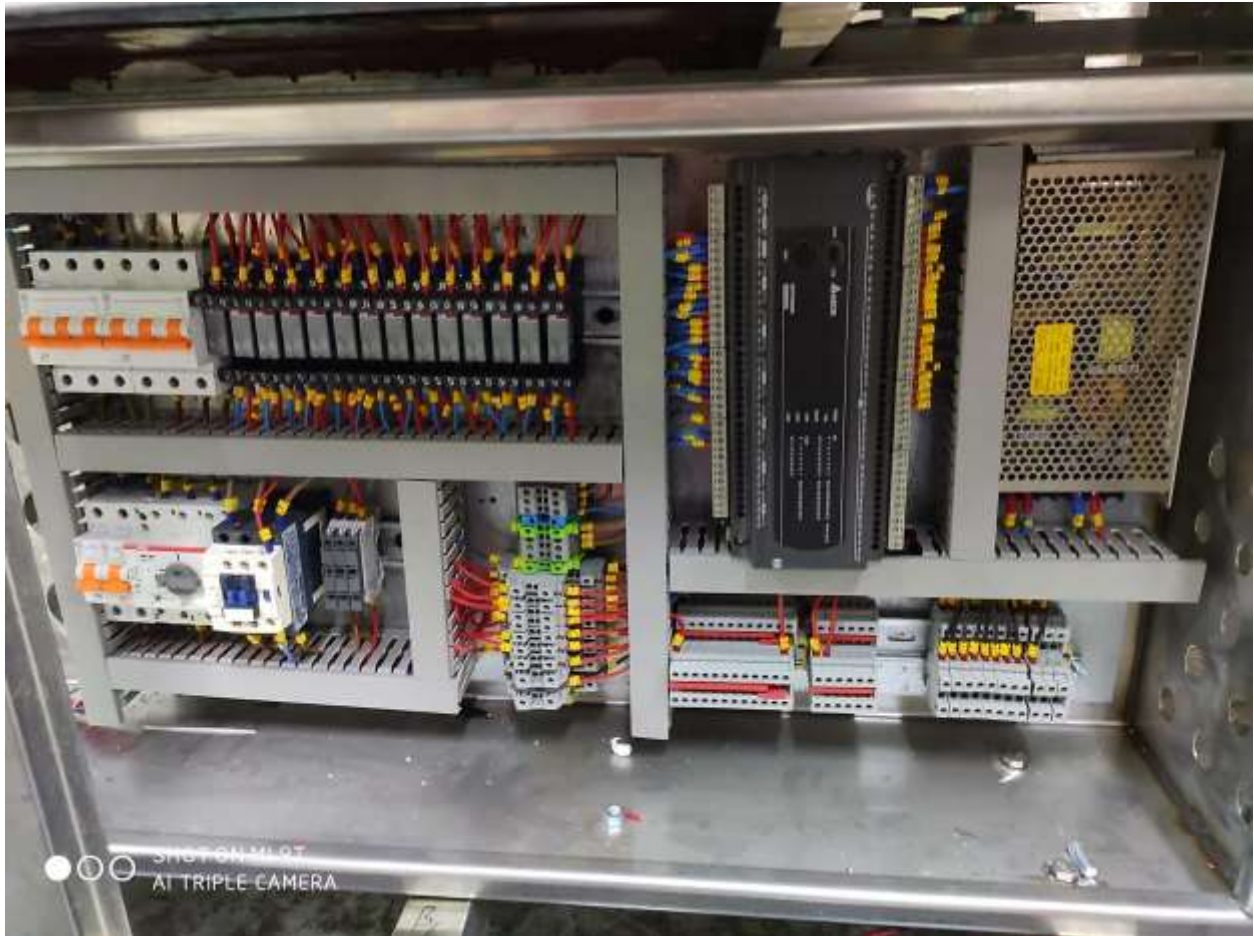

Figure 3.5 Electrical panel of the machine.

3.2 Pneumatic power

After we designed a control circuit, we connected +24 volt from PLC to the relay coils, whose ends are connected to the output ports of the PLC as shown in figure 4.3. Then, from the power supply, we connected +24 volt to the open contacts; the other side of the contacts are connected to the solenoids as shown in figure 3.7.

In the solenoids, we joined the common together and connected it to the power supply ground; whereas, we connected each positive side to an individual relay.

Figure 3.6 shows the part of pneumatic circuit, where the solenoid is connected with 5/2 way valve.



Figure 3.6 Solenoid connected with 5/2 way valve.

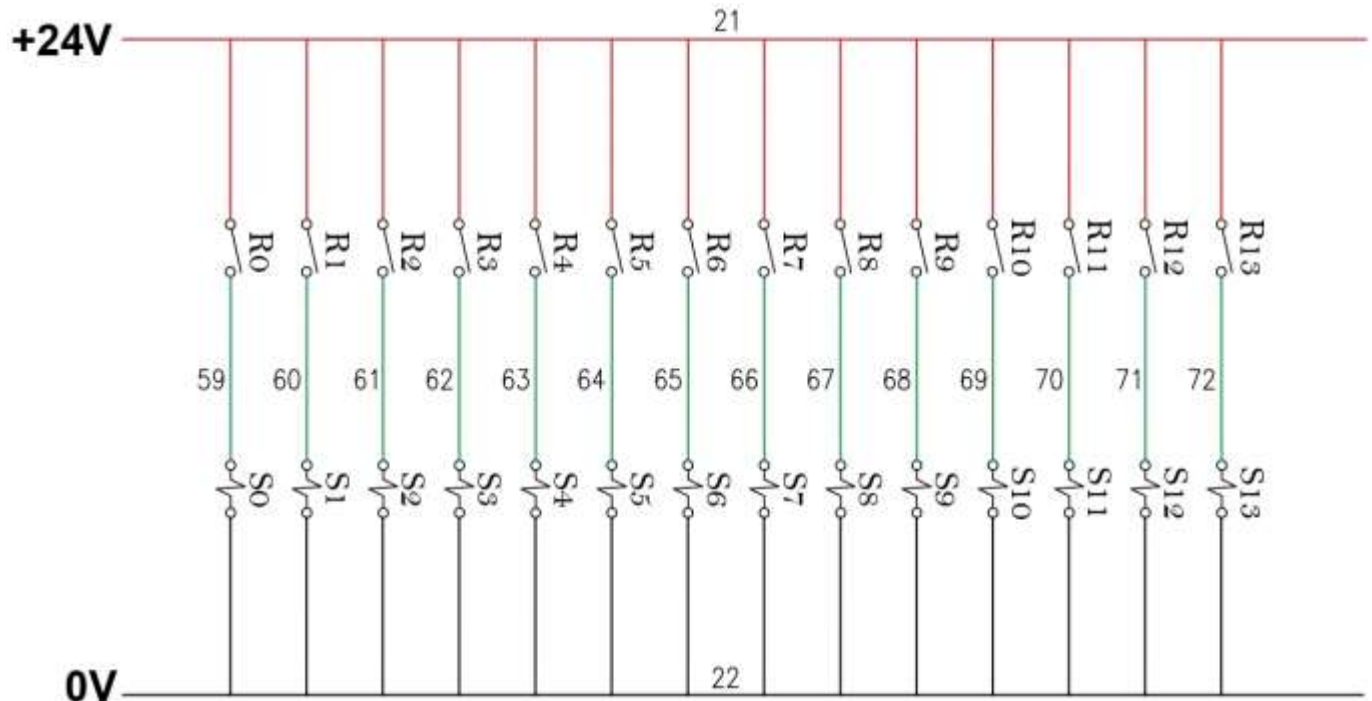

Figure 3.7 Relays and solenoids connected to the power supply.

Symbols of above circuit.





Name	Symbols	Quantity	Uses
Relay contacts NO		14 "R0-R13"	To protect the PLC output ports
Solenoid		14 "S0-S14"	Used to control valve electrically.
Red wire			Positive voltage wire
Black wire			Zero voltage wire
Green wire			Connections between parts

Table 3.2 Relays and solenoids circuit symbols.

In Al-Sharif factory, they use air tanks to supply various factory machines with the needed air. They provide machines with an 8 bar of pressure; our machine will be supplied with the same amount of pressure.

To better visualize the pneumatic circuit, we designed a circuit in FluidSIM program, which clearly shows how the solenoids, valves, and cylinders and connected to each other and how they are being supplied with an 8 bar pressure. As shown in figure 3.8.

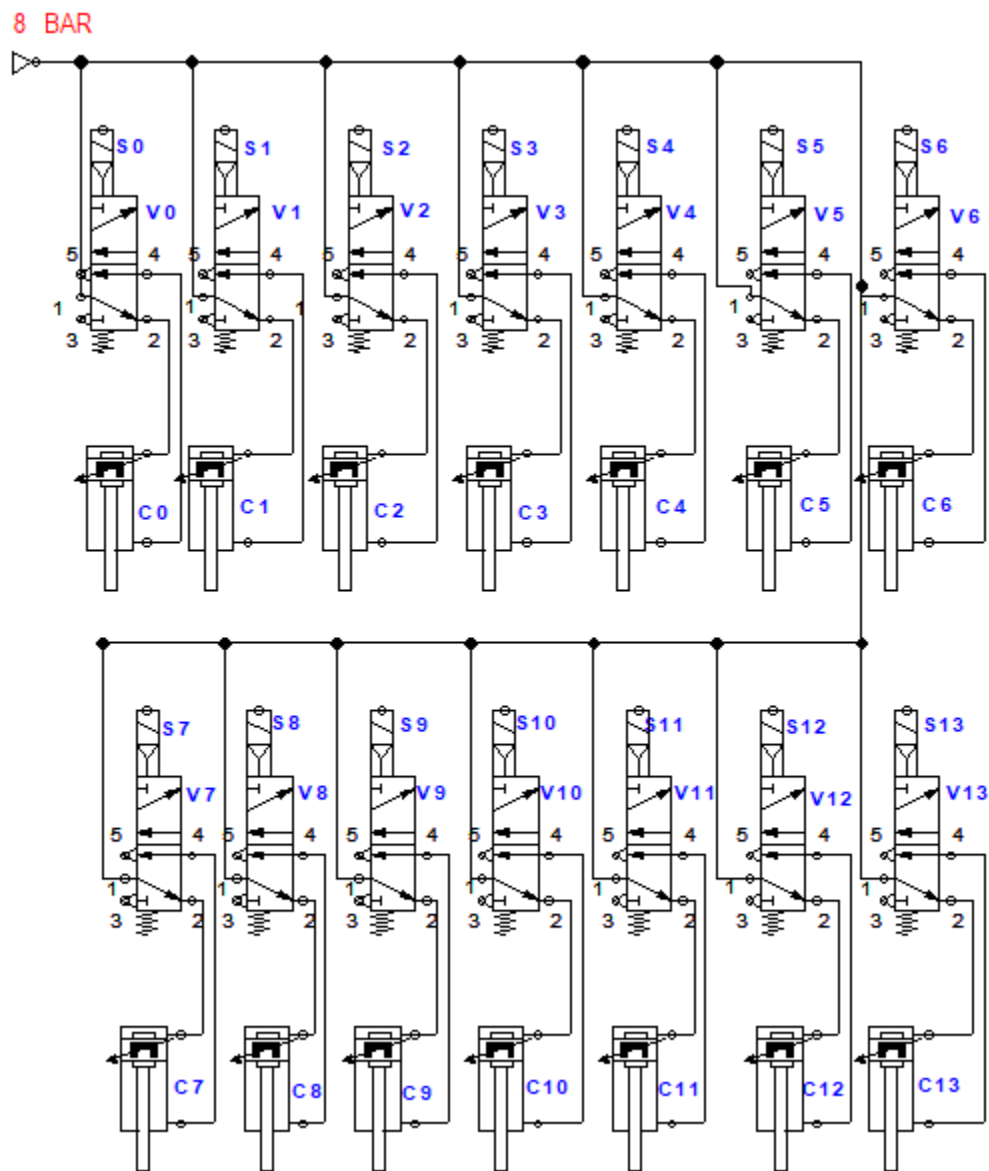

Figure 3.8 Pneumatic circuit.

3.2.1 Pneumatic circuit symbols



Name	Symbols	quantity	Uses
Compressed air supply		1	Used to give air to a pneumatic cylinder.
Solenoid		14 "S0-S13"	Used to control valve electrically.
5/2-Way Valve		14 "V0-V13"	Used to control the flow of air in a pneumatic system.
Pneumatic cylinder		14 "C0-C13"	Use the power of compressed gas to produce a force in a reciprocating linear motion.

Table 3.3 Pneumatic circuit symbols.



Figure 3.9 Pnuematic panel of the machine.

4

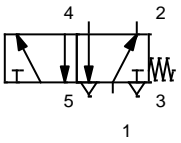
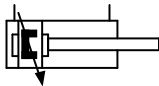
Control

After explaining the working principle of this machine, also should know what the control units used, in this machine there are two control units, this section will show and represent each control unit.

4.1 PLC



Figure 4.1 PLC-Delta

A programmable logic controller (PLC) or programmable controller is an industrial digital computer that has been ruggedized and adapted for the control of manufacturing processes, such as assembly lines or robotic devices, or any activity that requires high-reliability control and ease of programming and process fault diagnosis.

PLCs can range from small modular devices with tens of inputs and outputs (I/O), in a housing integral with the processor, to large rack-mounted modular devices with a count of thousands of I/O, and which are often networked to other PLC and SCADA systems.

They can be designed for multiple arrangements of digital and analog I/O, extended temperature ranges, immunity to electrical noise, and resistance to vibration and impact. Programs to control machine operation are typically stored in battery-backed-up or non-volatile memory.

It was from the automotive industry in the USA that the PLC was born. Before the PLC, control, sequencing, and safety interlock logic for manufacturing automobiles was mainly composed of relays, cam timers, drum sequencers, and dedicated closed-loop controllers. Since these could number in the hundreds or even thousands, the process for updating such facilities for the yearly model change-over was very time consuming and expensive, as electricians needed to individually rewire the relays to change their operational characteristics.

When digital computers became available, being general-purpose programmable devices, they were soon applied to control sequential and combinatorial logic in industrial processes. However, these early computers required specialist programmers and stringent operating environmental control for temperature, cleanliness, and power quality. To meet these challenges the PLC was developed with several key attributes. It would tolerate the shop-floor environment, it would support discrete (bit-form) input and output in an easily extensible manner, it would not require years of training to use, and it would permit its operation to be monitored. Since many industrial processes have timescales easily addressed by millisecond response times, modern (fast, small, reliable) electronics greatly facilitate building reliable controllers, and performance could be traded off for reliability.

4.1.1 Programming

PLC programs are typically written in a special application on a personal computer, then downloaded by a direct-connection cable or over a network to the PLC. The program is stored in the PLC either in battery-backed up RAM or some other non-volatile flash memory. Often, a single PLC can be programmed to replace thousands of relays.

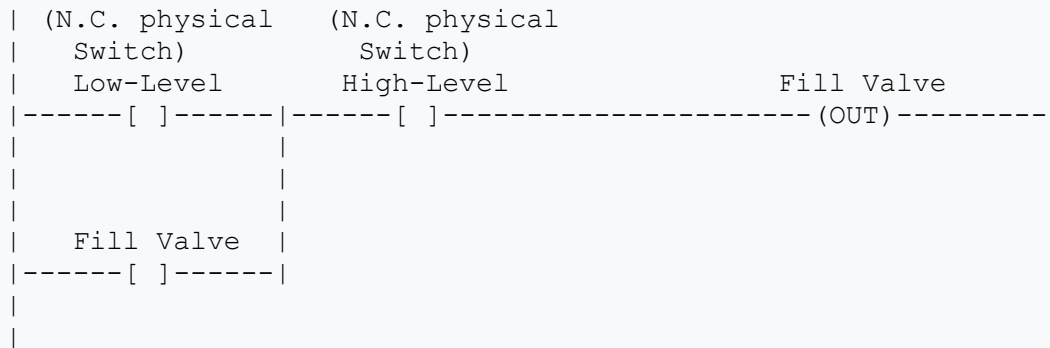

Ladder PLC program

About the PLC used in the machine:

The PLC used in the machine is DVP60ES2 from Delta DVP-ES2 series.

ES2 series is a small PLC for basic sequential control. It is economical, highly efficient and functional.

4.1.2 How the PLC works in the machine

Ch1 shows the working principle in general for this machine but did not explain how the control units work.

All inputs used in the machine are digital inputs like proximity sensors, limit switches, and push bottoms, are attached to the plc inputs, and from the output, we control the pneumatic cylinders for many functions, like open the gates, push the juice from the filling tanks, open the valves...etc.

This type of plc supplied using 220V ac, and the inputs 24V.

4.1.3 Control circuit

The first thing we must do before connecting anything to the input and output ports of the PLC is to connect the common, either positive (+ve) called source circuit or negative (-ve) called sink circuit. Figure 4.2 explains the difference between sink and source circuit.

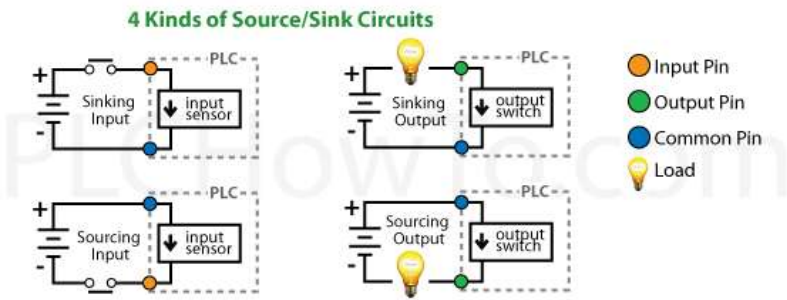

Figure 4.2 difference between sink and source circuit.

After clarifying sink and source circuit in addition to what we see in figure 4.3, we connected the common negative (-ve) so it is sink circuit.

In the control circuit, the sensors and switches were connected at the input ports of the PLC, and the output ports were connected to the relays, with one port connected to the contactor. The relay is connected to the solenoid, which is connected to the 5/2 way valve. The valve is connected to the pneumatic cylinders according to how we programmed them in PLC as shown in figure 4.3.

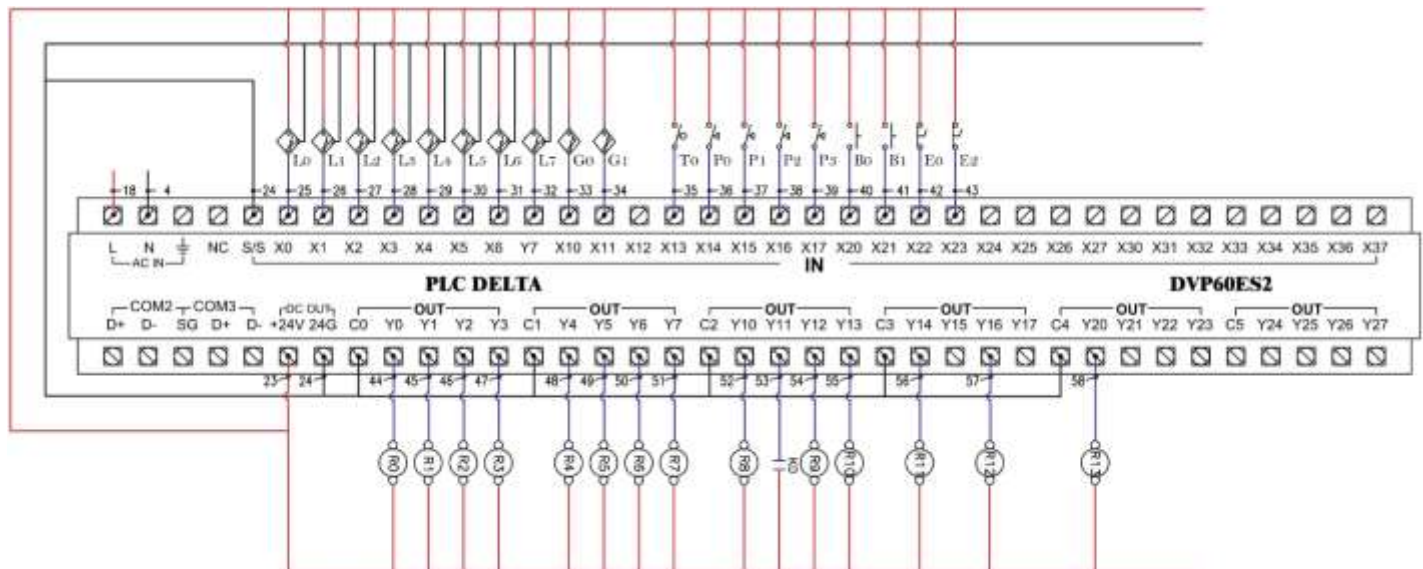
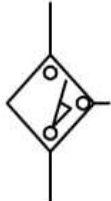

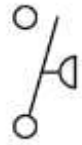





Figure 4.3 Control circuit of the machine.

4.1.4 Control circuit symbols

Name	Symbols	Quantity	Uses
Level Sensor 3 wire		8 "L0-L7"	Proximity sensor to determine the level of the juice in the bottles.
Counter Sensor 2 wire		2 "T0, T1"	Proximity sensor counts the bottle at the entrance and end gate.
Level Sensor 2 Wire		1 "T0"	Proximity sensor to determine the level of the juice in the tank.
Cylinder Sensor 2 wire		4 "P0-P3"	Used for position detection of pistons in pneumatic cylinders.
Push-button		2 "B0, B1"	Start and stop switch in the machine.
Limit Switch		2 "E0, E1"	Safety switch in the machine.
Relay coil		14 "R0-R13"	To protect the PLC output ports
Contactor		1 "K0"	Used to switch current to an electric motor

Red wire			Positive voltage wire
Black wire			Ground wire
Blue wire			Dark blue: control wire Light blue: neutral wire

Table 4.1 Control circuit symbols.

4.1.5 The flowchart of PLC programming

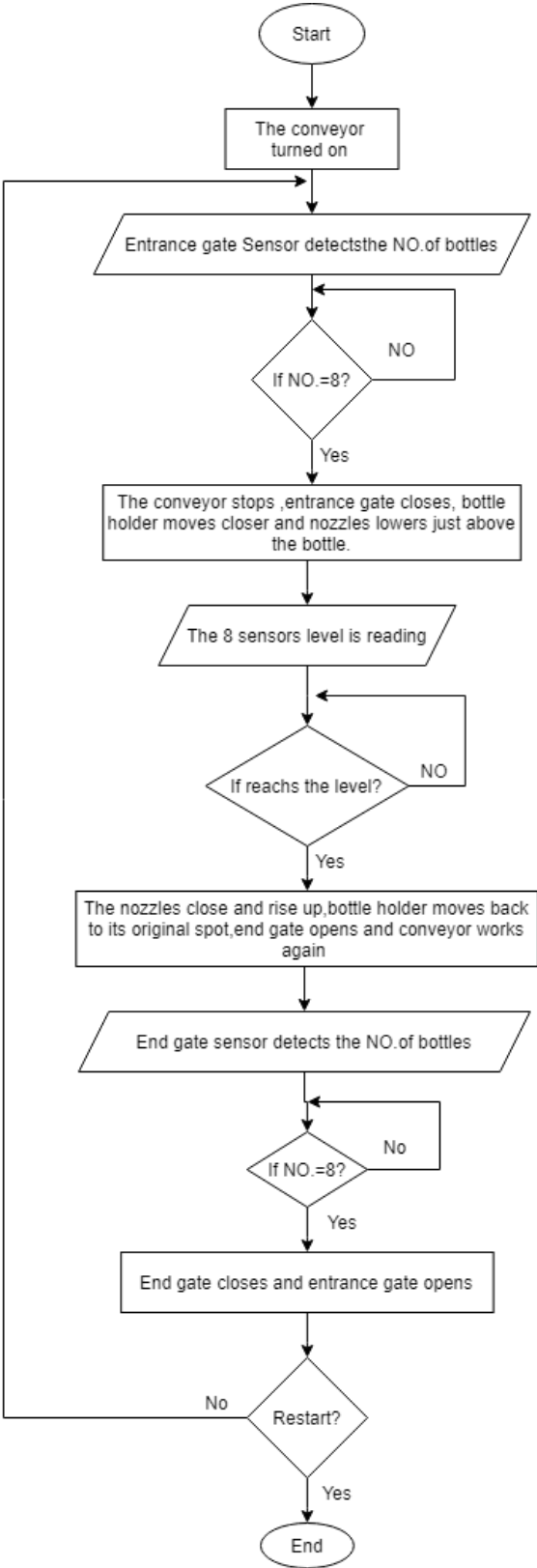

4.2 HMI

A Human-Machine Interface (HMI) is a user interface or dashboard that connects a person to a machine, system, or device. While the term can technically be applied to any screen that allows a user to interact with a device, HMI is most commonly used in the context of an industrial process.

Although HMI is the most common term for this technology, it is sometimes referred to as Man-Machine Interface (MMI), Operator Interface Terminal (OIT), Local Operator Interface (LOI), or Operator Terminal (OT). HMI and Graphical User Interface (GUI) are similar but not synonymous: GUIs are often leveraged within HMIs for visualization capabilities.

In industrial settings, HMIs can be used to:

- Visually display data
- Track production time, trends, and tags
- Oversee KPIs
- Touch screen
- And more

Similar to how you would interact with your air-conditioning system to check and control the temperature in your house, a plant-floor operator might use an HMI to check and control the temperature of an industrial water tank, or to see if a certain pump in the facility is currently running.

HMIs come in a variety of forms, from built-in screens on machines, to computer monitors, to tablets, but regardless of their format or which term you use to refer to them, their purpose is to provide insight into mechanical performance and progress.

And the most common type of HMI used in the industrial machines is the touch screen as shown in figure 4.4.



Figure 4.4 HMI Weinview.

4.2.1 Why touch screen?

The touch screen is the most common because the user can interact easily with the machine, the touch screen has inputs and outputs, and the user can see the state of the machine like the temperature, the level, the time....etc.

HMI type used in the machine:

The HMI used in the machine is a touch screen from Weinview.

The touch screen has many functions, can control the gates manually, starting the filling process after putting the bottles, stop the process, stop and run the conveyor.

And also the touch screen shows the states of the machine-like, the time of filling, the counter state, the tank state, and if the machine is in the filling stage.

4.2.2 Touch screen programming

We programmed the touch screen on easybuilder 8000 program as shown in the four figure be

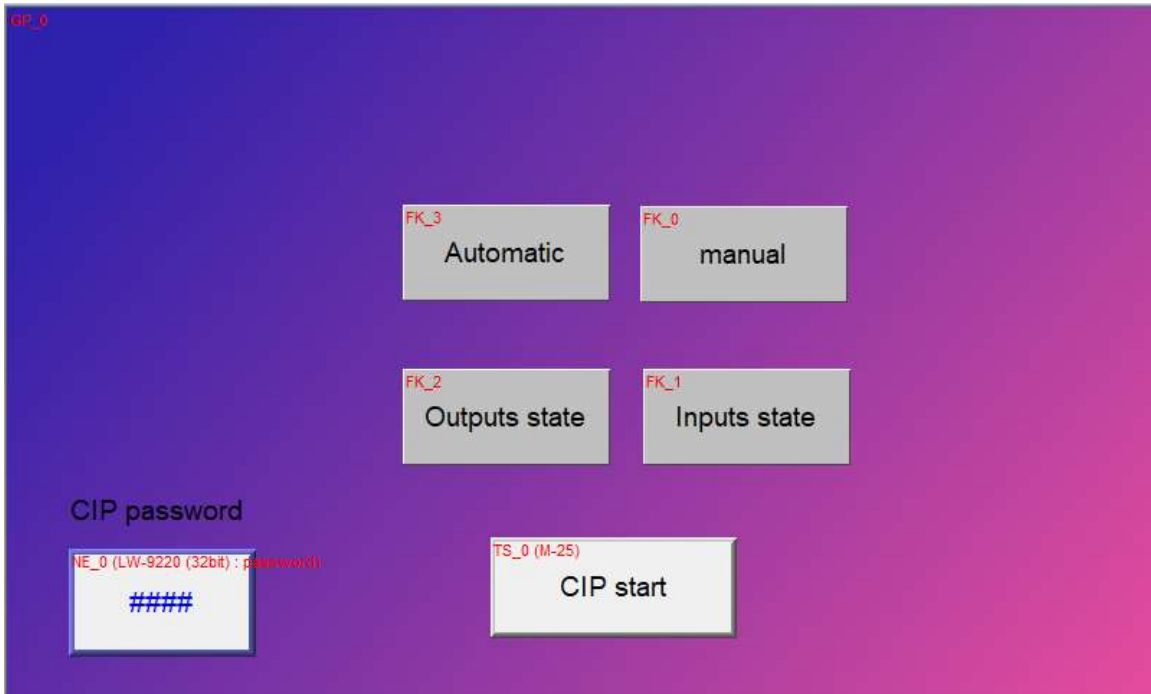

Figure 4.5 The main page for the touch screen program.

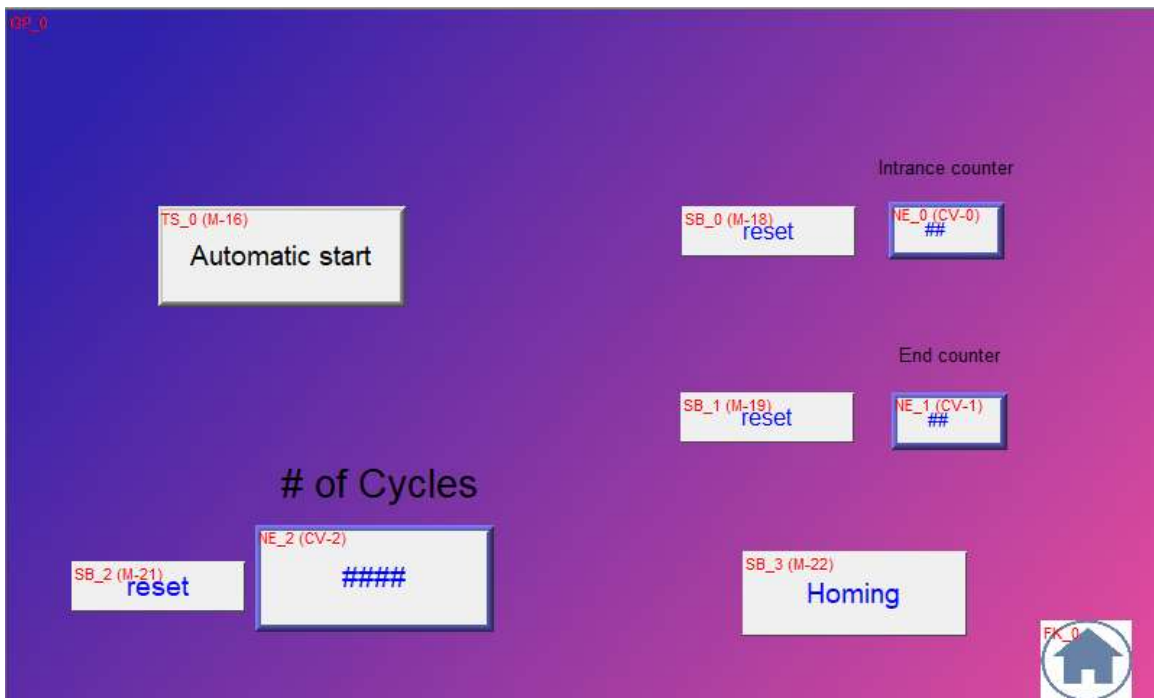

Figure 4.6 The automatic control of the machine using the touch screen.



Figure 4.7 The manual control of the machine using the touch screen.



Figure 4.8 Machine input status on the touch screen.



Figure 4.9 Machine output status on the touch screen.

5

Solutions

5.1 How the machine operated right before it was fixed

When we connected the machine to the power supply, the PLC, screen, and motor all functioned properly. However, all other components did not work because juice was stuck on all parts of the machine and rust has spread throughout. As a result, it was extremely difficult to get the machine to run again.

5.2 Suggested solutions

5.2.1 Suggested solutions for the foam problem

1- Use the iron filter at the nozzle, to get rid of bubbles so reduce the foam.

- **Advantages**

- A- Easy to install
- B- Reduce the foam significantly.
- C- Low cost

- **Disadvantages**

- A- The foam problem is not completely eliminated.
- B- Not solved level problem.
- C- Reduces fill speed.
- D- Requires daily cleaning with water to prevent the juice from sticking in the filter.
- E- Machine parts are not working so it is difficult to apply this solution.

2- Using servo motor works on lower the nozzle to the bottom of the bottle and Rises gradually as juice rise until the bottle is filled.

- **Advantages**

- A- Reduce the foam
- B- Filled the juice quickly

- **Disadvantages**

- A- Difficult to apply because of a small hole in the bottle.
- B- High cost.
- C- Higher electricity consumption

- D- Not solved level problem
- E- Need high height in the machine because the nozzle will lengthen.
- F- Machine parts are not working so it is difficult to apply this solution.

3- Tilting the bottle makes the juice flow smoothly

- **Advantages**

Reduce the foam.

- **Disadvantages**

- A- The machine fills 8 bottles at the same time, so it's difficult to tilt them all.
- B- The conveyor belt design is limited and does not allow a tilting bottle.
- C- Not solved level problem
- D- Machine parts are not working so it is difficult to apply this solution.

4- Filling the juice through gravity and use a wider nozzle.

- **Advantages**

- A- Reduce the foam.
- B- Saving electricity consumption.
- C- Low cost.

- **Disadvantages**

Inability to determine the level of juice in the bottles because of the cancellation of sizing containers.

5.2.2 Suggested solutions for the level problem

1- Replacement sizing containers and pneumatic cylinders that connect to sizing containers to new ones.

- **Advantages**

A- Solve the level problem.

B- Renewal machine parts.

- **Disadvantages**

A- The level problem will appear with used during the time.

B- Not solved foam problem.

C- High cost.

2- Use a balance to measure the weight of the Bottles.

- **Advantages**

A- Solve the level problem

B- Cancel sizing containers.

C- Get rid of the foam in case used filling through gravity.

- **Disadvantages**

A- Difficult to apply Because of the conveyor.

B- Difficult to link the balance with the hands of the Bottles.

C- The need for eight balances, for each of eight bottles.

3- Use a proximity sensor to determine the level of the juice in the bottles.

- **Advantages**

A. Easy to apply and connect.

B. Low cost.

C. High precision in filling juice.

D. Solve the level problem.

- E. Saving electricity consumption.
- F. It does not take up space in the machine.
- G. Make the machine smart.

- **Disadvantages**

- The need for eight sensors, for each of eight bottles.

5.2.3 Suggested solutions for the Machine is not working

1- Change the old parts with new ones

- **Advantages**

- A- Bring back the machine to work as new.
- B- Solve the level problem temporarily.
- C- Increasing productivity comparing to manual production.
- D- Increasing efficiency and work precision.
- E- Decrease the need for human factors.

- **Disadvantages**

- A- The level problem will back during the time.
- B- The foam problem not solved.
- C- The high cost of the replaced parts.

2- Cancel pneumatic cylinders that connect to sizing containers and filling through the gravity and cancel sizing containers and put sensors to determine the juice level in the bottles.

- **Advantages**

- A- Solve the foam problem.
- B- Solve the level problem.
- C- Bring back machine to work.
- D- Low cost.
- E- Increasing productivity comparing to manual production.
- F- Increasing efficiency and work precision.
- G- Decrease the need for human factors.

- **Conclusion**

Under these conditions, it is clear that the best solution filling juice through gravity and put sensors to determine the juice level in the bottles.

5.3 Practical experiments

1- Filling the juice through gravity with the same nozzle's size

We made an experiment in the factory while we were supervised by the division engineer, we got a funnel, pipe, nozzle, an empty bottle, and a juice-filled bottle, then we heated it till it reaches 50°C, after that, we poured the juice in funnel and flows through the pipe to the nozzle reaching the bottle as shown in figure 5.1.



Figure 5.1 Practical experiments filling the juice through gravity.

- **Results**

- A- Filling the bottle took 17 seconds.
- B- The foam problem was solved.
- C- The filling speed was good.

2- Determining the filling level

We made an experiment in a workshop, we got a sensor, a plastic cup half-filled with water and power supply, we connect the sensor to the power supply then we made the test by getting the cup near to the sensor as shown in figure 5.2.



Figure 5.2 Practical experiments of determining the filling level.

- **Results**

A- The sensor detects the water.

B- The sensor did not detect plastic.

5.4 Proximity sensor (level Sensor)

Model: CR30-15DP.

■ Specifications

Model	CR18-8DN CR18-8DP CR18-8DN2	CR30-15DN CR30-15DP CR30-15DN2	CR18-8AO CR18-8AC	CR30-15AO CR30-15AC
Sensing distance	8mm ±10%	15mm ±10%	8mm ±10%	15mm ±10%
Hysteresis	Max. 20% of sensing distance			
Standard sensing target	50×50×1mm (Iron)			
Setting distance	0 ~ 5.6mm	0 ~ 10.5mm	0 ~ 5.6mm	0 ~ 10.5mm
Power supply (Operating voltage)	12-24VDC (10-30VDC)		100-240VAC (85-264VAC)	
Current consumption	Max. 15mA		—	
Leakage consumption	—		Max. 2.2mA	
Response frequency(*1)	50Hz		20Hz	
Residual voltage	Max. 1.5V		Max. 20V	
Affection by Temp.	±10% Max. for sensing distance at +20℃ within temperature range of -25 ~ +70℃			
Control output	Max. 200mA		Max. 5 ~ 200mA	
Insulation resistance	Min. 50MΩ (at 500VDC mega)			
Dielectric strength	1500VAC 50/60Hz for 1 minute			
Vibration	1mm amplitude at frequency of 10 ~ 55Hz in each of X, Y, Z directions for 2 hours			
Shock	500m/s ² (50G) in X, Y, Z direction for 3 times			
Indicator	Operation indicator (Red LED)			
Ambient temperature	-25 ~ +70℃ (at non-freezing status)			
Storage temperature	-30 ~ +80℃ (at non-freezing status)			
Ambient humidity	35 ~ 95%RH			
Protection circuit	Surge protection circuit, Reverse polarity protection		Surge protection circuit	
Protection	IP66 (IEC standard)	IP65 (IEC standard)	IP66 (IEC standard)	IP65 (IEC standard)
Cable	φ4×3P, 2m		φ4×2P, 2m	
Unit weight	Approx. 72g	Approx. 212g	Approx. 63g	Approx. 220g

Figure 5.3 Level sensor specifications.

6

Conclusion and Recommendations

6.1 Conclusion

How the machine currently operates

After preparing the juice, which has a temperature of 50°C, it is filled in the tank. Then, we manually open the stopcock to move the juice through the pipe to the nozzle that's closed by a pneumatic cylinders that are connected to the nozzle. After that, we put the bottles on the Conveyor manually "by hand" then the Conveyor moves the bottles to the machine. The proximity sensor at the entrance counts eight bottles then closes the entrance gate using pneumatic cylinder. The end gate is already closed and the pneumatic cylinders that are connected to the nozzle will open. The juice will flow through the nozzle to fill the bottles until it reaches the level where the proximity sensor has been placed, next to the bottle. Then the pneumatic cylinders that are connected to the nozzle will close and the pneumatic cylinder opens the end gate to move the bottles out of the machine. The proximity sensor at the end gate counts eight bottles then the end gate closes and entrance gate opens again by pneumatic cylinder, and the cycle repeats.

Additional Feature

We added a clean in place "CIP" feature to the machine as part of the machine development. A clean in place is the scientific term for self-cleaning, where the machine is designed to clean itself. We placed a directional control valve behind the stopcock that is located at the entrance of the machine tank. Then, we connected the directional control valve with one end to the juice-supply tank, and the other end to a water pump. The system was then programmed on the PLC so that directional control valve remains open towards the juice-supply tank. As for water pumping, it works by a command that was added to the screen, which is manually pressed by the operator in charge of the machine. The directional control valve transfers the juice-supply tank to the water pump.

In order to avoid accidentally pressing the command in the screen, we have set a password that is activated whenever the machine needs to be cleaned.

6.2 Recommendations

- 1- Provide a machine that stacks bottles and places them onto conveyor.
- 2- Increase the number of nozzles in the back of machine by 8. This way, the machine can fill 16 bottles rather than 8.
- 3- Provide a machine that covers bottles after they are filled.

REFERENCES

- [1] Terri D. Boylston. (2007), Department of Food Science & Human Nutrition, 2547 Food Sciences Building, Iowa State University, Ames, IA 50011-1061, USA. P.1.
- [2] Manjunatha S.S., Raju P.S., Bawa A.S. (2012): Modelling the rheological behaviour of enzyme clarified lime (*Citrus aurantifolia* L.) juice concentrate, Siddarthanagar, Mysore, India.p.
- [3]Ward,R.(2011), A Brief History of Fruit and Vegetable Juice Regulation in the United States, Harvard Law School.p.1.
- [4] Mashilkar.B, Kumar.p, Chawathe.A, Dabhade.V, Kamath,V and Patil.G.(2016), Automated bottle filling system, Fr. C. R.I.T, Vashi, Navi Mumbai.p.1-3.

APPENDIX

Datasheets

APPENDIX A

Datasheet of Proximity Sensor

Electric Capacitive Type

Electric capacitive type proximity sensor

■ Features

- Able to detect iron, metal, plastic, water, stone, wood etc
- Long life cycle and High reliability
- Reverse power polarity, surge, overcurrent protection
- Easy to adjust of the sensing distance with sensitivity adjuster
- Red LED status indication
- Easy to control of level and position



⚠ Please read "Caution for your safety" in operation manual before using.

■ Type

◎ DC 3-wire type

Appearances	Model
M18	CR18-8DN
	CR18-8DP
	CR18-8DN2 *
M30	CR30-15DN
	CR30-15DP
	CR30-15DN2 *

◎ AC 2-wire type

Appearances	Model
M18	CR18-8AO
	CR18-8AC
M30	CR30-15AO
	CR30-15AC

▶ "*" mark can be customized.

■ Specifications

Model	CR18-8DN CR18-8DP CR18-8DN2	CR30-15DN CR30-15DP CR30-15DN2	CR18-8AO CR18-8AC	CR30-15AO CR30-15AC
Sensing distance	8mm ±10%	15mm ±10%	8mm ±10%	15mm ±10%
Hysteresis	Max. 20% of sensing distance			
Standard sensing target	50×50×1mm (Iron)			
Setting distance	0 ~ 5.6mm	0 ~ 10.5mm	0 ~ 5.6mm	0 ~ 10.5mm
Power supply (Operating voltage)	12-24VDC (10-30VDC)		100-240VAC (85-264VAC)	
Current consumption	Max. 15mA		—	
Leakage consumption	—		Max. 2.2mA	
Response frequency(*1)	50Hz		20Hz	
Residual voltage	Max. 1.5V		Max. 20V	
Affection by Temp.	±10% Max. for sensing distance at +20°C within temperature range of -25 ~ +70°C			
Control output	Max. 200mA		Max. 5 ~ 200mA	
Insulation resistance	Min. 50MΩ (at 500VDC mega)			
Dielectric strength	1500VAC 50/60Hz for 1 minute			
Vibration	1mm amplitude at frequency of 10 ~ 55Hz in each of X, Y, Z directions for 2 hours			
Shock	500m/s ² (50G) in X, Y, Z direction for 3 times			
Indicator	Operation indicator (Red LED)			
Ambient temperature	-25 ~ +70°C (at non-freezing status)			
Storage temperature	-30 ~ +80°C (at non-freezing status)			
Ambient humidity	35 ~ 95%RH			
Protection circuit	Surge protection circuit, Reverse polarity protection		Surge protection circuit	
Protection	IP66 (IEC standard)	IP65 (IEC standard)	IP66 (IEC standard)	IP65 (IEC standard)
Cable	∅4×3P, 2m		∅4×2P, 2m	
Unit weight	Approx. 72g	Approx. 212g	Approx. 63g	Approx. 220g

*(*1) The response frequency is the average value. The standard sensing target is used and the width is set as 2 times of the standard sensing target, 1/2 of the sensing distance for the distance.

(A) Counter

(B) Timer

(C) Temp. controller

(D) Power controller

(E) Panel meter

(F) Tacho/Speed/Pulse meter

(G) Display unit

(H) Sensor controller

(I) Switching power supply

(J) Proximity sensor

(K) Photo electric sensor

(L) Pressure sensor

(M) Rotary encoder

(N) Stepping motor & Driver & Controller

(O) Graphic panel

(P) Production stoppage models & replacement

CR Series

■ Dimensions

● CR18-8D□

● CR18-8A□

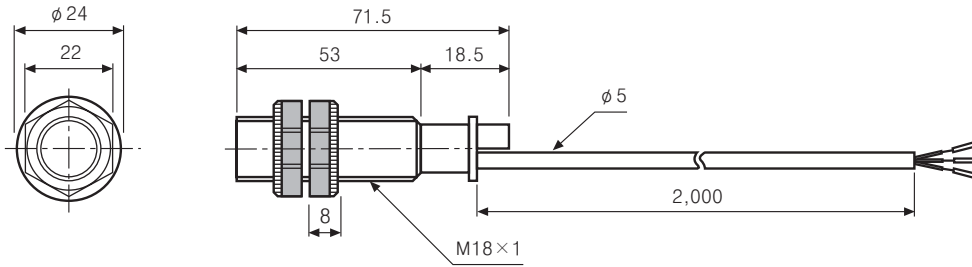

● CR30-15D□

● CR30-15A□

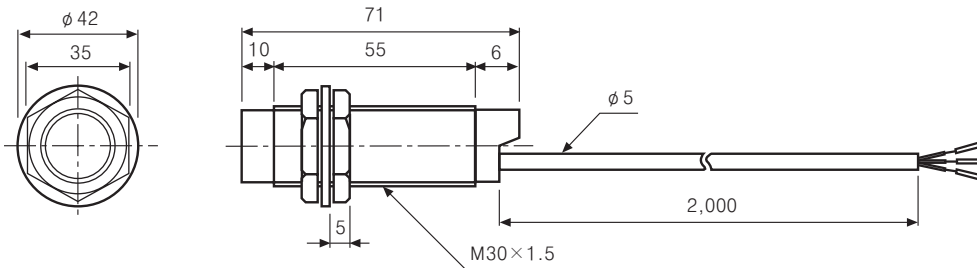

(Unit:mm)

■ Control output diagram

◎ DC 3-wire type

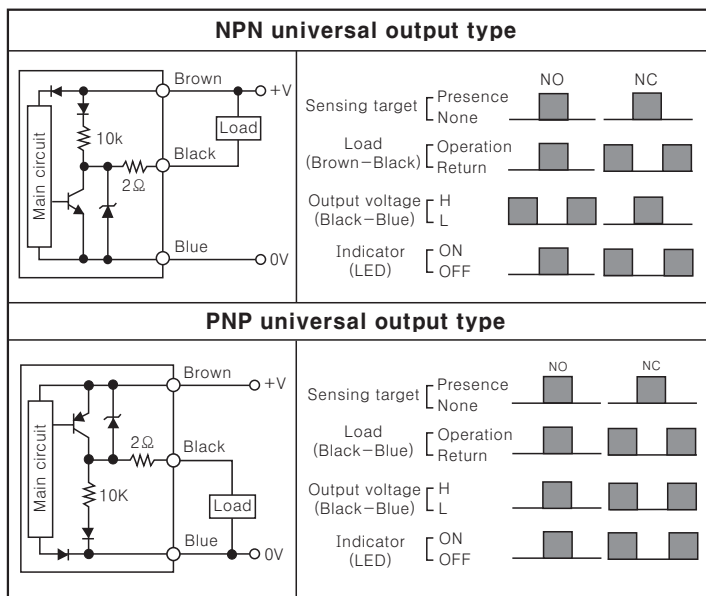

◎ AC 2-wire type

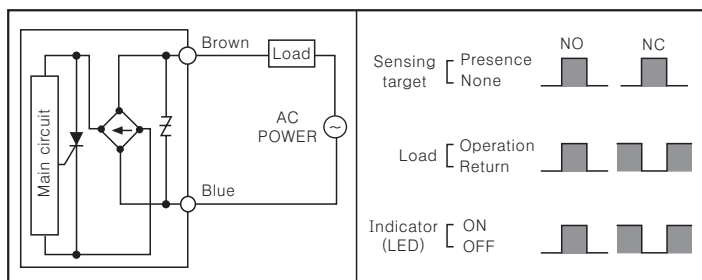

■ Connections

◎ DC 3-wire type

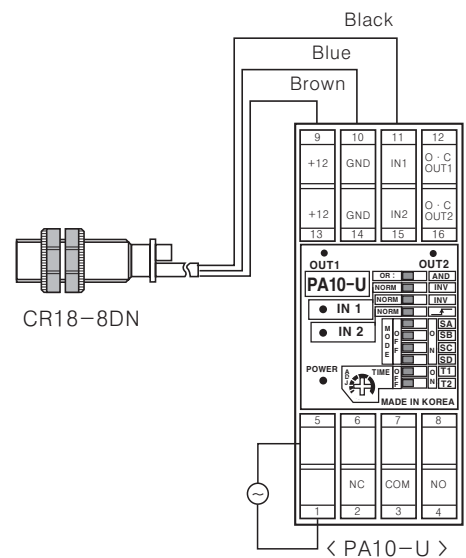

◎ AC 2-wire type

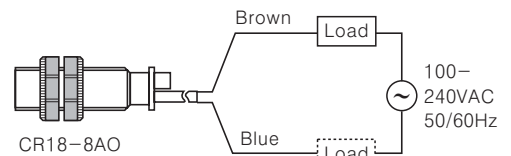

※ The load can be connected to either wire.

Electric Capacitive Type

■ Sensitivity adjustment

Please turn potentiometer and set sensitivity as below procedure.

- 1 Without a sensing object, turn the potentiometer to the right and stop at the proximity sensor is ON(OFF).
- 2 Put the object in right sensing position, turn the potentiometer to the left and stop at the proximity sensor is OFF(ON).

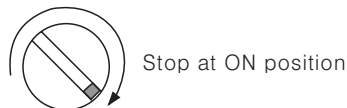

- 3 If the difference of the number of potentiometer rotation between the ON(OFF) point and the OFF(ON) point is more than 1.5 turns, the sensing operation will be stable.
- 4 If it is set in sensitivity adjustment position of potentiometer at center between 1 and 2, sensitivity setting will be completed.

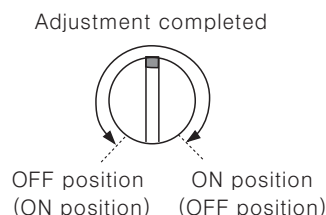
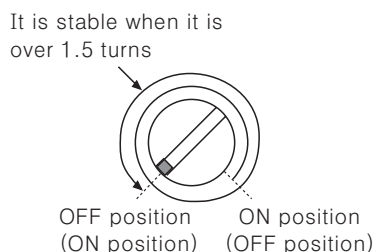

- ※ When there is distance fluctuation between proximity sensor and the target, please adjust 2 at the farthest distance from this unit.
- ※ Turning potentiometer toward clockwise, it will be Max. and turning toward counter clockwise, it will be Min. the number of adjustment should be 15 ± 3 revolution and if it is turned to the right or left excessively, it will not stop, but it idles without breakdown.
- ※ () is for Normal Close type.

■ Grounding

The sensing distance will be changed by grounding status of capacitive proximity sensor and the target [50×50×1mm(Iron)]. Please check the material when installing it on panel.

● CR18 Type

Ground condition (Switch b)	ON	OFF
Operating distance (mm)	8	4

● CR30 Type

Ground condition	Switch a	ON	OFF	ON	OFF
	Switch b	ON	ON	OFF	OFF
Operating distance(mm)		15	18	6	6

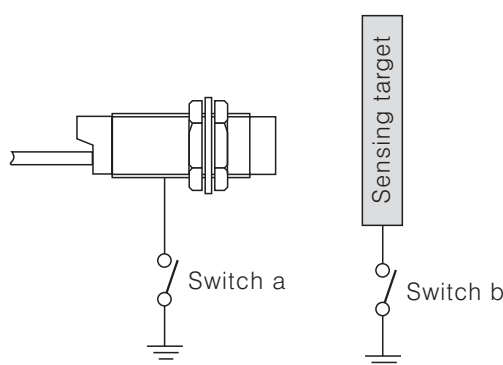
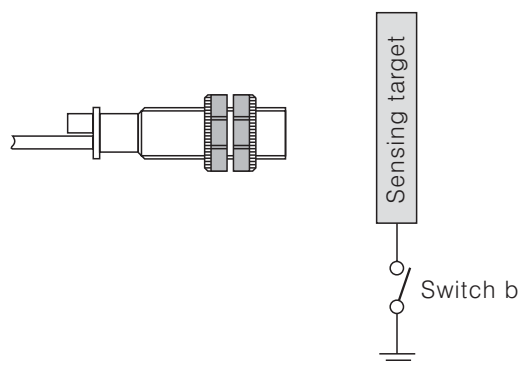

(A) Counter

(B) Timer

(C) Temp. controller

(D) Power controller

(E) Panel meter

(F) Tacho/Speed/Pulse meter

(G) Display unit

(H) Sensor controller

(I) Switching power supply

(J) Proximity sensor

(K) Photo electric sensor

(L) Pressure sensor

(M) Rotary encoder

(N) Stepping motor & Driver & Controller

(O) Graphic panel

(P) Production stoppage models & replacement

CR Series

■ Mutual-interference & Influence by surrounding metals

When several proximity sensors are mounted closely, malfunction of sensor may be caused due to mutual interference. Therefore, be sure to provide a minimum distance between the two sensors, as below charts.

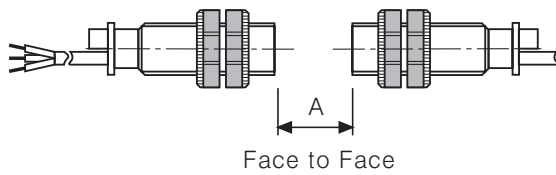

Face to Face

Model Item	CR18	CR30
A	48	90
B	54	90

(Unit:mm)

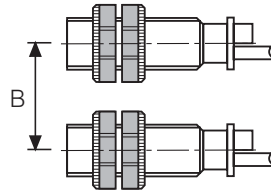

Parallel

When sensors are mounted on metallic panel, you must prevent the sensors from being affected by any metallic object except target. Therefore, provide minimum distance as shown.

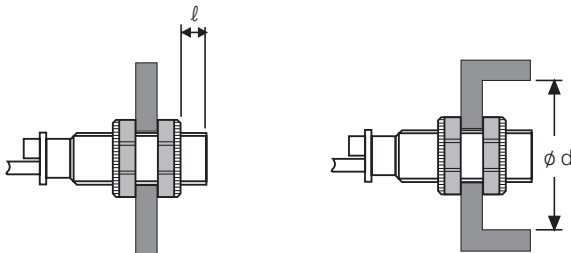

Model Item	CR18	CR30
l	20	10
ϕd	54	90
m	24	45
n	54	90

(Unit:mm)

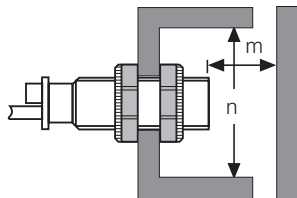

■ Materials

○ Materials of sensing targets

Sensing distance may be different by electrical characteristic of sensing target (Conductivity, Non dielectric constant) and status of water absorption, size etc.

○ Effect by high frequency electrical field

It may cause malfunction by machinery which generate high frequency of electrical field such as a washing machine etc.

○ Surrounding environment

There is water or oil on surface of sensing part, it may cause malfunction.

If the bottle for detecting of level is coated by oil etc., it may cause malfunction.

Especially, 15mm type has high sensitivity for induced objects, please be careful of waterdrops.

○ Oil

Do not let the oil or oil liquid is flowed into the sensor, the case is made by plastic.

APPENDIX B

PLC Code

PLC codes

