

**Palestine Polytechnic University**  
**College of Engineering**



**A Comparison between two engine ECUs**

By

Shareef Salman

Laith Amro

Supervisor:

Dr .Diya Arafah

Submitted to the College of Engineering  
in partial fulfillment of the requirements for the  
Bachelor degree in Automotive Engineering

**Hebron, May 2017**

## Dedication

الى الوطن فلسطين .... الى شوارعه وازقة المخيم ومقبرة الشهداء .  
الى ايقونة النصر , الشهداء والجرحى .  
الى من سطروا بأمعانهم الخاوية اكبر معاني التضحية والكرامة اسرانا البواسل  
الى من تحت اقدامها الجنة ... امي ربيع قلبي ومهجة فوادي.  
الى الجبل الشامخ الذي يقف في وجه الاعاصير من اجلي ... ابي الحبيب .  
الى الدرر الكامنة ... اخوتي واخواتي .  
الى الاصدقاء والاحبة .... الى مشرفي العزيز ...  
الى كل الجنود المجهولين الذين وقفوا خلف نجاحي طوال السنين .  
اليكم جميعا اهدي ثمرة نجاحي هذه .

## **Acknowledgment**

All praise and thanks is due to Allah, the lord of mankind and all that exists for his blessings, benevolence, and guidance at every stage of our life. Our thanks go first to our supervisor Dr. Diya Arafahis guidance and support made this work possible.

We would also like to thank Eng. Mohammed Aljamal, Eng. Qais Naser Eddin, Eng. Muayad Oweidah Dweik, for all their efforts in helping us.

And finally, ultimate thanks go to our families and friends . whom their constant support for us improved our work to reach success .

## Abstract

The auto world has become newly matched technology and programmatic development; modern cars are very similar in terms of external design and mechanical components. Several companies produce vehicles carrying the same mechanical characteristics among these companies is Škoda.

Modern cars have their own control unit, this unit is the mastermind of vehicle engine. Škoda issuing two versions of the Fabia and Octavia owned the same mechanical properties but there is a difference in engine output power so that Octavia produce more power than Fabia by 16.7%. In order to find out what the company has done to increase power we extracted and compared the MAPs stored in the two ECUs. An increase in fuel consumption for Octavia due to modifications done on the fuel and turbo MAPs; is the direct cause of the increase in engine output power.

ان عالم السيارات أصبح حديثا يواكب التكنولوجيا والتطور البرمجي فأصبحت السيارات الحديثة متشابهة من حيث التصميم الخارجي والميكانيكي .

اتناء بحثنا في مجال التقدم البرمجي للسيارات وجدنا ان هناك شركات عدة تنتج سيارات تحمل الصفات الميكانيكية نفسها ومن ضمن هذه الشركات هي شركة سكودا .

تمتلك السيارات الحديثة وحدة تحكم خاصة بها وان هذه الوحدة هي العقل المدبر لمعظم مشغلات المركبة بناءً على قراءات من الحساسات ومعالجتها ضمن خرائط محفوظة داخلها, قامت شركة سكودا بإصدار مركبتين من اصدار فابيا و اوكتافيا يمتلكن نفس الخصائص الميكانيكية ولكن هناك فرق في القوة الخارجة من المحرك حيث ان الاوكتافيا تزيد عن الفابيا بنسبة ١٦,٧% في القوة ومن اجل معرفة ما قامت به الشركة لزيادة القوة سنقوم ببحثنا هذا حيث سنقوم بجلب وحدتي التحكم الخاصة بالمركبتين وايجاد الفرق بينهم .

بعءما قءنا بالتأكد من اءءلاك المرءبءءن نفس الءصائص المءكانءكءة ثم قراءة الءراءء في كل وءءة ءءكم وءفسءر الفروقات الءء قاءء الشرة بءءءلها ءبءن لءءنا زءاءة فء اسءءءاك الوقوء لساءرة اوءءافءا وءءا السبب المباشر لءءاءة القوء الءارءة من مرءكها نءءءة ءءءءاءء ءصاءء على ءراءء الوقوء وءءءءوء .

## Table of contents

Dedication.....	1
Acknowledgment.....	2
Abstract.....	3
Table of contents .....	5
List of Figures.....	8
List of tables .....	9
CH.1: Introduction.....	12
1.1. Project Objective .....	12
1.2. Project Importance.....	12
1.3. Project Methodology .....	13
1.4. Expected budget: .....	14
1.5. Time table.....	15
CH.2: Automotive Electronic Control Unit.....	18
2.1. Introduction .....	18
2.2. Electronic Control Unit 'ECU'.....	20
2.2.1. ECU Hardware structure. ....	20
2.2.2. ECU Software.....	21
2.2.3. ECU Implementation in modern vehicles .....	22
2.2.4 Controller Area Network (CAN bus) .....	23
CH.3: Engine Sensors and actuators .....	26
3.1. Input (Sensors).....	26
3.1.1. Boost Pressure Sensor (BPS).....	26

3.1.2. Manifold absolute pressure (MAP) Sensor .....	27
3.1.3. Mass air flow sensor (MAF).....	27
3.1.4. Oxygen sensor .....	27
3.1.5. Intake Air Temperature Sensor (IAT) .....	28
3.1.6. Throttle Position Sensor (TPS).....	28
3.1.7. Accelerator-pedal sensors.....	29
3.1.8. Crankshaft Position Sensor (CKPs).....	29
3.1.9. Camshaft Position Sensor (CMPs) .....	30
3.1.10. Coolant Temperature Sensor (CTS) .....	30
3.1.11. Vehicle Speed Sensor (VSS).....	31
3.2. Outputs device (Actuators).....	31
3.2.1 Fuel pump control unit .....	31
3.2.2 High-pressure fuel injector .....	32
3.2.3. Exhaust gas recirculation (EGR).....	33
CH.4: Diesel Engine Management .....	36
4.1. Engine Management System (EMS) .....	36
4.2 Engine Management System operation.....	36
4.2.1. Engine temperature control .....	37
4.2.2. Cranking fuel control.....	37
4.2.3. Idle speed control .....	38
4.3. Diesel engine control.....	38
4.4. Common-rail system (CRS) .....	38
4.4.1. Fuel Injecting Quantity (I.Q).....	39

4.4.2. Start of Injection (SOI) .....	40
4.4.3. Controlling the Pressure of Turbochargers.....	40
4.4.4. Turbocharger boost control. ....	40
4.5 Engine ECU MAP .....	42
4.5.1 Introduction of the ECU MAP .....	42
4.5.2 Devices for extracting the MAPs from the ECU.....	42
4.5.3 Programs for reading ECU MAPs.....	43
CH.5: Case study (Fabia and Octavia) .....	46
5.1. Case study procedure:.....	46
5.2. All MAPs in Engine ECU: .....	46
5.3. MAPs modified in the two Engine ECUs: .....	47
5.3.1: Driver Wish .....	47
5.3.2. Injection Quantity limit by mass air flow .....	49
5.3.3 Torque Limit.....	51
5.3.4 Injection duration: .....	53
5.3.5. Start of Injection (SOI).....	56
5.3.6 Turbocharger MAPs .....	58
CH 6: Conclusion and Recommendations.....	66
6.1. Conclusion.....	66
6.2 Recommendations .....	67
References .....	68



## List of Figures

Figure 2. 1.Balancing Operating Priorities.....	18
Figure 2. 2power and fuel consumption as a function AIR fuel ratio .....	19
Figure 2. 3 ECU hardware structure.....	20
Figure 2. 4networking in modern vehicles .....	24
Figure 3. 1sensors located in the vehicle.....	26
Figure 3. 2Characteristic curve of an accelerator-pedal sensor.....	29
Figure 3.3 PWM signals .....	31
Figure 3. 4Design of high-pressure fuel injector.....	32
Figure 3.5: Actuation of high-pressure fuel injector .....	33
Figure 4. 1.KESS v2 device .....	42
Figure 4.2: ECU into BDM frame.....	43
Figure 4.3: Map search in WinOLS .....	44

## List of tables

Table 1. 1Cost Table .....	14
Table 1. 2Time table for the research: first semester .....	15
Table 1. 3Time table for the research: second semester .....	16
Table 5.1: Driver wish for Fabia .....	48
Table 5.2; Driver wish for Octavia .....	48
Table 5.3: Driver wish percentage difference between Octavia and Fabia. ....	49
Table 5.4: Smoke limit for Fabia .....	50
Table 5.5: Smoke limit for Octavia.....	50
Table 5.6: Smoke limit percentage difference between Fabia and Octavia.....	51
Table 5.7: Torque Limit for Fabia .....	52
Table 5.8: Torque Limit for Octavia.....	52
Table 5.9: Torque Limit percentage difference between Octavia and Fabia. ....	53
Table 5.10:Injection duration 0 for Fabia.....	54
Table 5.11: Injection duration 0 for Octavia.....	55
Table 5.12: Injection duration 0 percentage difference between Octavial and Fabia.....	56
Table 5.13: Start of Injection SOI 0 for Fabia .....	57
Table 5.14: Start of Injection SOI 0 for Octavia.....	57
Table 5.15:Start of injection SOI 0 Percentage Differences between Octavia and Fabia.	58
Table 5.16: Boost pressure for fabia .....	59
Table 5.17: Boost pressure for Octavia.....	59
Table 5.18: Boost pressure percanteg difference between Octavia and Fabia .....	60

Table 5. 19.Boost Limiting MAP for Fabia.....	61
Table 5. 20.Boost Limiting MAP for Octavia .....	61
Table 5. 21.Boost Limiting MAP percentage difference between Octavia and Fabia .....	61
Table 5.22: N75 Duty Cycle for Fabia.....	63
Table 5.23: N75 Duty Cycle for Octavia.....	63
Table 5.24: N75 duty cycle percentage difference between Octavia and Fabia .....	64

# Chapter One

## **CH.1: Introduction**

### **1.1. Project Objective**

Engine power is a very important specification for any internal combustion engine, it depends on several variables including the amount of fuel injected, the timing of ignition and so on, in the past the engine variables were controlled by means of mechanical components, nowadays with the huge advance in technology and electronics, most control is being implemented within Electronic Control Units “ECU”. The ECU is responsible for controlling engine variables based on dedicated software within the ECU called MAP. The process of modifying ECU MAP for a specific operating condition (sport or economy) is widely spread and very common. Such modifications may be applied on the engine without any further hardware adjustment.

The present project is a comparison of ECU MAP modification to increase engine power; this will be accomplished by investigating two identical TDI engines manufactured by Škoda with different ECU MAP tuning. Fabia and Octavia. We have been interested in the manual of Škoda 1600 16v TDI have two editions of engines, CAYB & CAYC. Both engines have the same mechanical components but different output power, CAYB engines used in Fabia have 90 hp, on the other hand CAYC engines used in Octavia have 105hp. It worth to mention that Octavia has a higher weight and larger wheelbase compared with Fabia.

### **1.2. Project Importance**

This project is important for the local market, especially with the development of existing control systems in vehicles as sufficient knowledge in this subject for professionals in the local market and this form of motivation for selecting project

### **1.3. Project Methodology**

The project has been divided into two stages, the first stage is establishing a scientific background to describe the variables affecting engine ECU performance. Special device and software will be used in the second stage to read and compare the ECU MAPs implemented within the Škoda 1600 16v TDI (CR) Fabia and Octavia engines.

#### 1.4. Expected budget:

This project has estimated to consume 1000\$.

Table 1. 1Cost Table

The items	cost
Two ECU (engine ECUs: <b>Fabia, Octavia</b> )	500\$
KEES V2 Device	400\$
WinOLS software	<b>100\$</b>
Total cost	1000\$

### 1.5. Time table

We estimate the time for this project to be accomplished and it will take 16work weeks.

Table 1. 2Time table for the research: first semester

Week	1	2	3	4	5	6	7	8	9	10	11	12	13	14	15	16
Mission																
Selecting project idea	■	■	■	■												
State of art review					■	■	■	■	■							
Selecting reading device									■	■	■					
Selecting modifying software										■	■	■	■			
Making report												■	■	■		
Making presentation															■	■



Table 1. 3Time table for the research: second semester

Week	1	2	3	4	5	6	7	8	9	10	11	12	13	14	15	16
Mission																
Engines specifications	■	■	■	■												
Remapping device and software					■	■										
Comparison of ECU MAPs							■	■	■	■	■	■	■			
Making report												■	■	■		
Making presentation															■	■

## **Chapter Two**

## CH.2: Automotive Electronic Control Unit

### 2.1. Introduction

The amount of electronics in the vehicle is raised dramatically in recent years and is set to increase yet further in the future. Technical developments in semiconductor technology support ever more complex functions with the increasing integration density. The functionality of electronic systems in motor vehicles has now surpassed even the capabilities of the Apollo 11 space module that orbited the Moon in 1969 [1].

Digital technology furnishes an extensive array of options for open and closed-loop control of automotive electronic systems. A large number of parameters can be included in the process to support optimal operation of various systems. The control unit receives the electrical signals from the sensors, evaluates them, and then calculates the triggering signals for the actuators. The control program, the "software", is stored in a special memory and implemented by a microcontroller. The control unit and its components are referred to as hardware.

Modern engine management systems allow power train designers to maintain the critical balance between performance, fuel economy, and emissions. As government regulations concerning emissions and fuel economy become more demanding, the need for advanced fuel delivery technologies and operational strategies that can meet these exacting standards becomes greater.



Figure 2. 1. Balancing Operating Priorities

It has long been known that the key to efficient combustion is maintaining the proper relationship between air and fuel. The point at which fuel burns most efficiently is known as the stoichiometric ratio. The stoichiometric ratio is approximately 14.7 (air) to 1 (fuel).

Keeping this relationship constant is a challenge, as the engine must operate under continually changing conditions and loads. Figure 2.2 shows the relation between power, fuel consumption as a function of air fuel ratio.

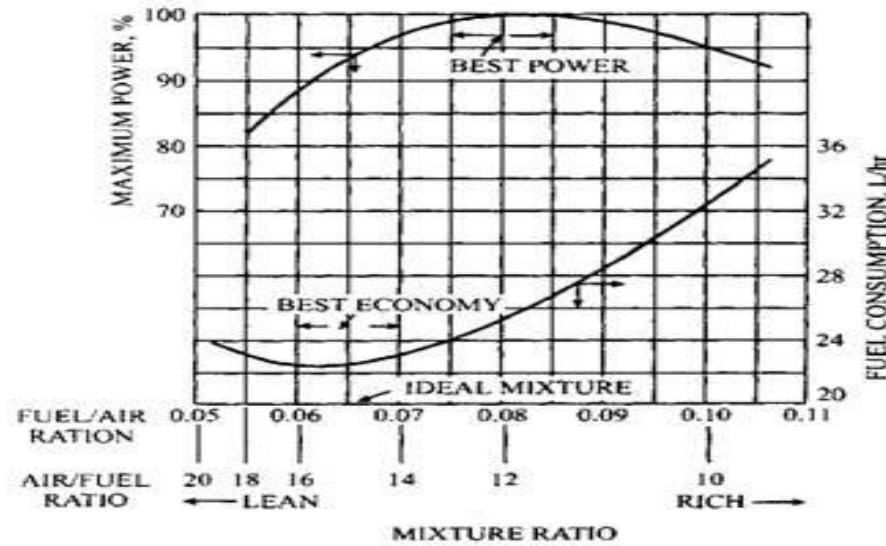

Figure 2. 2power and fuel consumption as a function AIR fuel ratio

Once the stoichiometric ratio has been achieved, igniting the air/fuel mixture at the appropriate time presents the next big challenge. Although it seems to occur instantaneously, combustion takes time. And while combustion time remains relatively constant, the environment in which it occurs (an automotive cylinder with a moving piston) changes dramatically depending on engine speed. The appropriate spark timing at idle will not be the most effective point of ignition at 4,000 rpm. The key is not to compromise, but to provide the best point of ignition for every operating condition. A modern engine needs a system to manage the complex collection of inputs and outputs and correctly interpret the ways they relate to each other. The control of the air fuel mixture and the ignition process is crucial; nowadays this control strategy is implanted within ECU. Incorrect application of any of these three inputs (air/fuel/ignition) can lead to unsatisfactory performance, poor fuel economy, and/or excessive exhaust emissions.

## 2.2. Electronic Control Unit 'ECU'

In the Automobile industry an Electronic Control Unit (ECU) is an embedded electronic device, basically a digital computer, that read signals coming from sensors placed at various parts and in different components of the vehicle and depending on this information controls various important units (e.g. engine and automated operations within the vehicle) and also keeps a check on the performance of some key components used in the vehicle.

An ECU is basically made up of hardware and software. The hardware is basically made up of various electronic components on a Printed Circuit Board (PCB). The most important of these components is a microcontroller chip along with an EPROM or a Flash memory chip. The software is a set of lower-level codes that runs in the microcontroller. Figure 2.3 shows the ECU hardware structure [2].

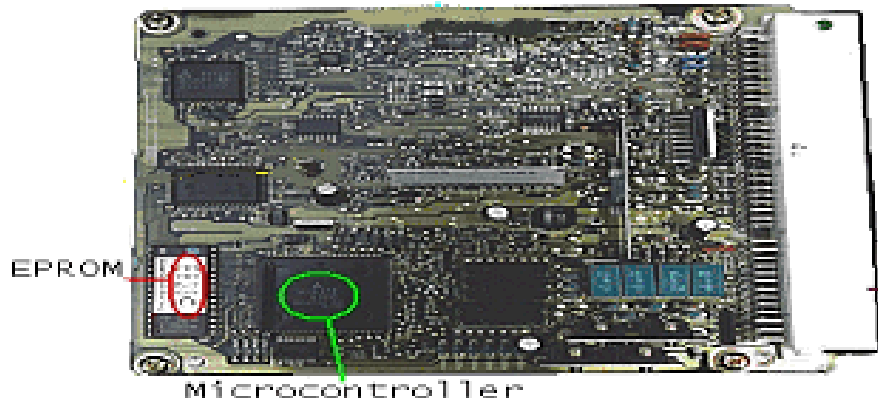

Figure 2. 3 ECU hardware structure

### 2.2.1. ECU Hardware structure.

#### 2.2.1.1. Microcontroller Structure:

Central Processing Unit (CPU): this contains the control unit and the arithmetic and logic unit. The control unit executes the instructions from the program memory, whereas the arithmetic and logic unit performs arithmetical and logical operations [2].

### **2.2.1.2. Memory:**

Program memory, in which the operating program (user program) is permanently stored (Read Only Memory 'ROM', programmable Read Only Memory 'PROM', Erasable Programmable Read-Only 'EPROM' or flash EPROM).

Data memory, which is accessed for reading and writing (Random Access Memory 'RAM'). This contains the data that is currently being processed. Non-volatile memory (electrically erasable programmable read-only 'EEPROM') is used for data that must not be deleted when the supply voltage is switched off [2].

### **2.2.1.3. Bus system:**

The bus system connects the individual elements of the microcontroller. A clock generator (oscillator) ensures that all operations in the microcontroller take place within a defined timing pattern.

### **2.2.1.4. Logic circuits:**

Logic circuits are modules with specialized tasks such as program interrupts. They are integrated in individual I/O units. The chief components of a microcomputer are generally separate modules connected to one another on a printed-circuit board. The microprocessor within such as system - the CPU - is not functional on its own: it is always part of a microcomputer. In a microcomputer, however, the abovementioned functions are integrated on a silicon wafer (system-on-a-chip). This is not functional on its own (standalone) and is therefore referred to as a single chip microcomputer. The microcontroller is used to control self-regulating systems such as an engine management system. Depending on the application, they may also have expansion modules connected to them (e.g. additional memory for data and program code). The user program is fixed and is not replaced for different applications. This is the difference between a microcontroller system, for example, and a PC.

## **2.2.2. ECU Software**

### **2.2.2.1. Real-Time Capability**

One of the requirements on electronic systems is real-time capability. This means that control procedures must react to input signals within an extremely short time. Engine

management systems make considerable real-time capability demands so that crankshaft angles can be adhered to with extreme accuracy at fast engine speeds for injection and ignition timing purposes. The complexity of an electronic system therefore makes extremely high demands of the software that is developed [3].

#### **2.2.2.2. Software Structure**

The microcontroller in the control unit executes commands sequentially. The command code is obtained from the program memory. The time taken to read in and execute the command depends on the microcontroller that is used and the clock frequency. The microcontrollers that are currently used in vehicles can execute up to 1 million commands per second. Because of the limited speed at which the program can be executed, a software structure with which time-critical functions can be processed with high priority is required. The engine-management program has to react extremely quickly to signals from the speed sensor, which records the engine speed and the crankshaft position. These signals arrive at short intervals that can be a matter of milliseconds, depending on the engine speed. The control unit program has to evaluate these signals with high priority. Other functions such as reading in the engine temperature are not as urgent, since the physical variable only changes extremely slowly in this case.

#### **2.2.3. ECU Implementation in modern vehicles**

There are different ECUs used for different systems on the vehicle. The different ECUs used can be for the engine, transmission, traction control or ABS, AC, body functions and lighting control, air bags, or any other system a vehicle may have. Some vehicles may incorporate more than one ECU into a single unit called a Power train Control Module (PCM). These units can be an advantage by having more modules in one location but may be a disadvantage by adding longer wires to reach the component it operates.

Most new vehicles have started using a communication line between different modules on a vehicle so they can share information and redundant sensors do not have to be used.

The use of sharing input sensors throughout the vehicle using only two data lines between ECUs has cut the amount of wiring used in the vehicles. Sharing information between

modules also means they need a common language between them so they can operate as a group.

The engine ECU in most vehicles is connected to the onboard diagnostic connector and will relay all diagnostic information on this line to all the other modules or ECUs. This reduces the amount of wire needed and you do not need to go to each ECU during testing.

#### **2.2.4 Controller Area Network (CAN bus)**

A Controller Area Network (CAN bus) is a vehicle bus standard designed to allow microcontrollers and devices to communicate with each other in applications without a host computer (see figure 2.4). It is a message-based protocol, designed originally for multiplex electrical wiring within automobiles, but is also used in many other contexts.

The modern automobile may have as many as 70 Electronic Control Units (ECU) for various subsystems. Typically the biggest processor is the engine control unit. Others are used for transmission, airbags, antilock braking/ABS, cruise control, electric power steering, audio systems, power windows, doors, mirror adjustment, battery and recharging systems for hybrid/electric cars, etc. Some of these form independent subsystems, but communications among others are essential. A subsystem may need to control actuators or receive feedback from sensors. The CAN standard was devised to fill this need. One key advantage is that interconnection between different vehicle systems can allow a wide range of safety, economy and convenience features to be implemented using software alone - functionality which would add cost and complexity if such features were "hard wired" using traditional automotive electrics.



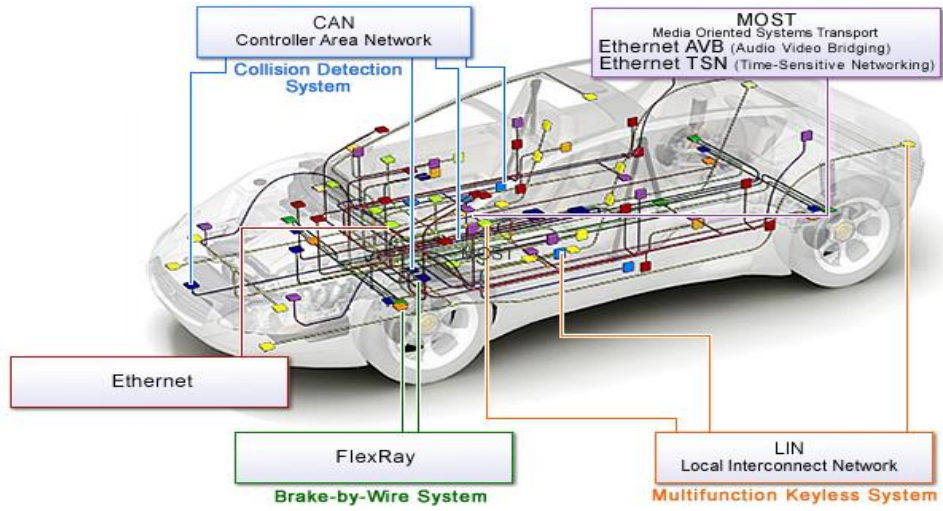

Figure 2. 4networking in modern vehicles [4]

## **Chapter Three**

## CH.3: Engine Sensors and actuators

### 3.1. Input (Sensors)

Many sensors are used in the vehicle to provide the ECU with the needed information, the most common sensors are explained below.

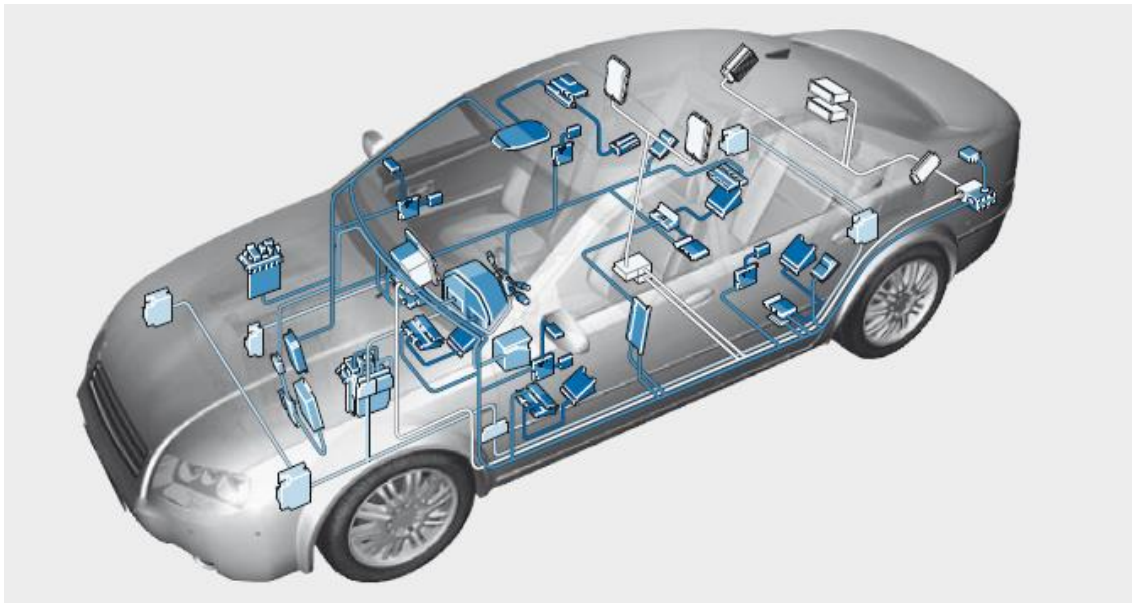

Figure 3. 1sensors located in the vehicle

#### 3.1.1. Boost Pressure Sensor (BPS)

Boost pressure sensors are used in turbocharged engines to provide air pressure information and air and fuel ratios in order to regulate engine performance. As a complex piece of technology, a boost pressure sensor has been an impressive addition to engine technology. Boost pressure sensors control the boost level produced in the intake manifold of a turbocharged or supercharged engine. They affect the air pressure delivered to the pneumatic and mechanical waste gate actuator.

### **3.1.2. Manifold absolute pressure (MAP) Sensor**

The Manifold Absolute Pressure (MAP) senses engine load. The sensor generates a signal that is proportional to the amount of vacuum in the intake manifold. The ECU then uses this information to adjust ignition timing and fuel enrichment.

When the engine is working hard, intake vacuum drops as the throttle opens wide. The engine sucks in more air, which requires more fuel to keep the air/fuel ratio in balance. In fact, when the ECU reads a heavy load signal from the MAP sensor, it usually makes the fuel mixture go slightly richer than normal so the engine can produce more power. At the same time, the ECU will retard (back off) ignition timing slightly to prevent detonation (spark knock) that can damage the engine and reduce performance.

### **3.1.3. Mass air flow sensor (MAF)**

The mass air flow sensor convert the amount of air drawn by the engine into voltage signal, the ECU needs to know the volume of intake air. This is necessary to determine how much fuel to inject, when to ignite the cylinder. Basically, an engine generates power by burning gasoline. In order for a vehicle to produce more horsepower, it has to burn more gasoline, which requires more air. Meaning that if an engine is using more air, it will generate more horsepower, however, extra emission will result.

### **3.1.4. Oxygen sensor**

An oxygen sensor (or lambda sensor) is an electronic device that measures the proportion of oxygen (O<sub>2</sub>) in the gas or liquid being analyzed.

Automotive oxygen sensors make modern electronic fuel injection and emission control possible. They help determine, in real time, if the air fuel of a combustion engine is rich or lean. Since oxygen sensors are located in the exhaust stream, they do not directly measure the air or the fuel entering the engine but when information from oxygen sensors is coupled with information from other sources, it can be used to indirectly determine the air fuel ratio. Closed loop feedback-controlled fuel injection varies the fuel

injector output according to real-time sensor data rather than operating with a predetermined (open-loop) fuel MAP. In addition to enabling electronic fuel injection to work efficiently, this emissions control technique can reduce the amounts of both unburnt fuel and Nitrogen Oxides rejected into the atmosphere.

Modern spark-ignited combustion engines use oxygen sensors and catalytic converters in order to reduce exhaust emissions. Information on Oxygen concentration is sent to the engine control unit (ECU), which adjusts the amount of fuel injected into the engine to compensate for excess air or excess fuel. The ECU attempts to maintain, on average, a certain air fuel ratio by interpreting the information it gains from the Oxygen sensor. The primary goal is a compromise between power, fuel economy, and emissions, and in most cases is achieved by an air fuel ratio close to stoichiometric.

#### **3.1.5. Intake Air Temperature Sensor (IAT)**

The Intake Air Temperature sensor (IAT) monitors the temperature of the air entering the engine. The (ECU) needs this information to estimate air density so it can balance air/fuel mixture. Colder air is denser than hot air, so cold air requires more fuel to maintain the same air/fuel ratio. The ECU changes the air/fuel ratio by changing the length (on time) of the injector pulses.

#### **3.1.6. Throttle Position Sensor (TPS)**

Throttle Position Sensor (TPS) to inform the ECU of accelerator pedal and throttle plate position. TPS is normally mounted on the throttle body with the throttle plate shaft running into the sensor. As the gas pedal is pushed, the throttle plate opens, rotating the sensors internal variable resistor. As the throttle opens, voltage returned to the ECU from the TPS varies (normally increasing), signaling the rate of throttle opening as well as throttle position. The ECU uses this information to adjust fuel trim, which is the amount of time the injectors are open, delivering more fuel.

### 3.1.7. Accelerator-pedal sensors

The accelerator-pedal sensor records the travel or the angular position of the accelerator pedal. For this purpose, potentiometers are used in addition to proximity-type sensors. The accelerator pedal sensor is incorporated with the accelerator pedal in the accelerator pedal module. These ready-to-install units make adjustments on the vehicle a thing of the past.

The engine control unit receives the measured value picked off at the potentiometer wiper as a voltage. The control unit uses a stored sensor curve to convert this voltage into the relative pedal travel or the angular position of the accelerator pedal (see Figure. 3.2).

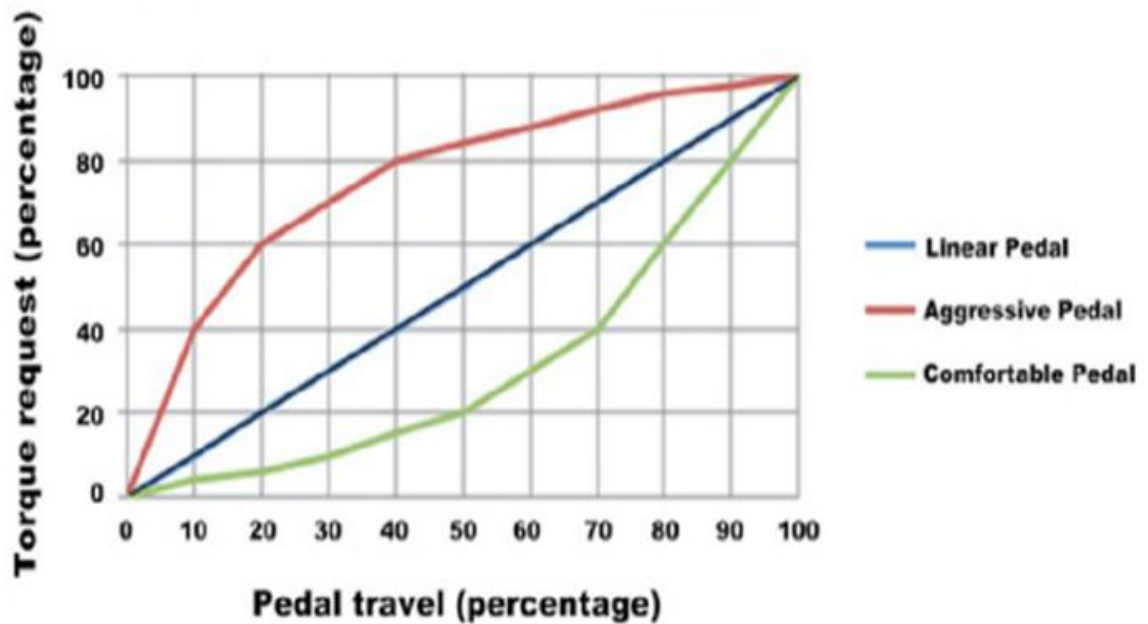

Figure 3. 2Characteristic curve of an accelerator-pedal sensor

### 3.1.8. Crankshaft Position Sensor (CKPs)

Crankshaft Position Sensor is attached to the crankshaft of a car's engine. The purpose of a CKP sensor is to measure the speed at which the crankshaft spins. This sensor sends crucial information to the engine control unit (ECU). The information from a CKP sensor is used to control the engine management and ignition timing systems. The

engine RPM (revolutions per minute), timing (advance or retard) and firing order are determined by the information which is received from the CKP sensor.

### **3.1.9. Camshaft Position Sensor (CMPs)**

Camshaft position sensor is used to keep the ECU informed about the position of the camshaft relative to the crankshaft. By monitoring cam position (which allows the ECU to determine when the intake and exhaust valves are opening and closing), the ECU can use the cam position sensor's input along with that from the crankshaft position sensor to determine which cylinder in the engine's firing sequence is approaching top dead center. This information is then used by the ECU to synchronize the pulsing of fuel injectors so they match the firing order of the engine. On some applications, input from the camshaft position sensor is also required for ignition timing.

### **3.1.10. Coolant Temperature Sensor (CTS)**

The Coolant Temperature Sensor is used to measure the temperature of the engine coolant of an internal combustion engine. The readings from this sensor are then fed back to the (ECU), which uses this data to adjust the fuel injection and ignition timing. On some vehicles the sensor may also be used to switch on the electric cooling fan. The data may also be used to provide readings for a coolant temperature gauge on the dashboard. The ECU sends out a regulated reference voltage (typically 5 volts) to the coolant temperature sensor. The voltage drop across the sensor will change according to the temperature because its resistance changes. The ECU is then able to calculate the temperature of the engine, and then (with inputs from other engine sensors) uses lookup tables to carry out adjustments to the engine actuators, i.e. change the fuel injection or ignition timing. This is necessary because in order to run smoothly, a cold engine requires different timing and fuel mixture than an engine at operating temperature.

### 3.1.11. Vehicle Speed Sensor (VSS)

A Vehicle Speed Sensor generates a magnetic pulse in the form of a wave proportional to the speed of the vehicle. The ECU uses the VSS frequency signal to manipulate multiple electrical subsystems in a vehicle, such as fuel injection, ignition, cruise control operation, torque, and clutch lock-up.

## 3.2. Outputs device (Actuators)

### 3.2.1 Fuel pump control unit

The fuel pump control unit receives a signal from the ECU and controls the electrical fuel pump with a PWM signal (pulse-width modulation). It regulates the pressure in the low-pressure fuel system between 0.5 and 5 bar. The pressure is raised up to 6.5 bar for warm and cold starts.

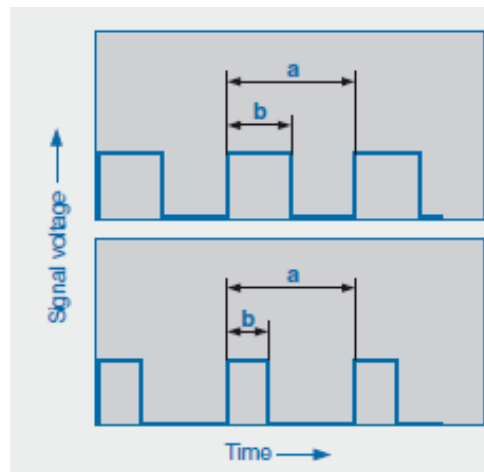

Figure 3.3 PWM signals

- a. Period duration
- b. Variable on-time



### 3.2.2 High-pressure fuel injector

It is the function of the high-pressure fuel Injector on the one hand to meter the fuel and on the other hand by means of its atomization to achieve controlled mixing of the fuel and air in a specific area of the combustion chamber. Depending on the desired operating status. This lifts the valve needle off the valve seat against the force of the spring and opens the injector outlet bores, see figure 3.4. The primary pressure now forces the fuel into the combustion chamber. The injected fuel quantity is essentially dependent on the opening duration of the fuel injector and the fuel pressure. When the energizing current is switched off, the valve needle is pressed by spring force back down against its valve seat and interrupts the flow of fuel. Excellent fuel atomization is achieved thanks to the suitable nozzle geometry at the injector tip.

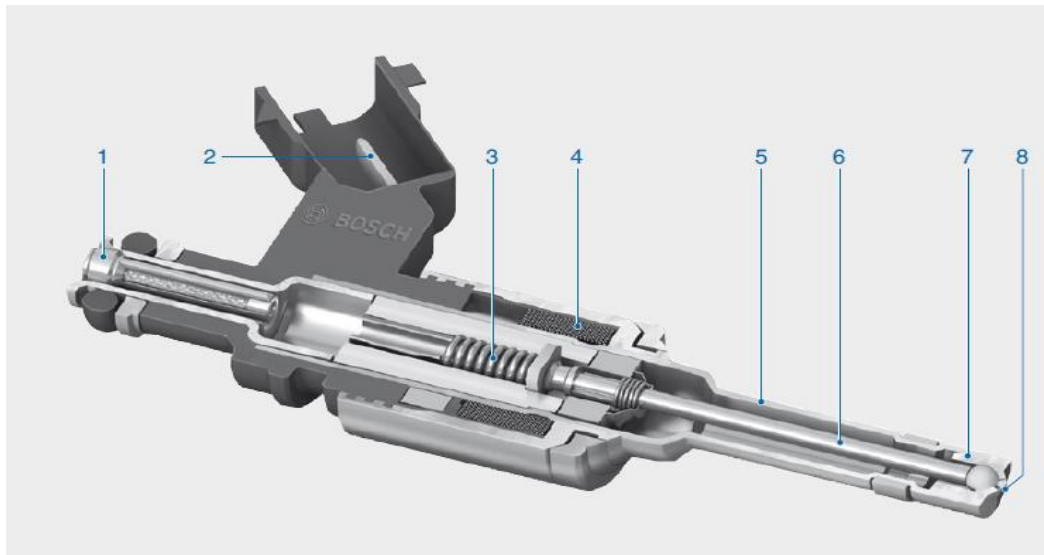

1. Fuel inlet with filter, 2. Electrical connection, 3. Spring, 4. Coil, 5. Valve sleeve, 6. Nozzle needle with solenoid armature, 7. Valve seat, 8. Injector outlet bores

Figure 3. 4 Design of high-pressure fuel injector

The high-pressure fuel injector must be actuated with a highly complex current curve in order to comply with the requirements for defined, reproducible fuel-injection processes (Fig.3.5). The microcontroller in the ECU delivers a digital triggering signal (a). An

output module (ASIC) uses this signal to generate the triggering signal (b) for the fuel injector. A DC/DC converter in the engine ECU generates the booster voltage of 65V. This voltage is required in order to bring the current up to a high value as quickly as possible in the booster phase. This is necessary in order to accelerate the injector needle as quickly as possible. In the pickup phase, the valve needle then achieves the maximum opening lift (c). When the fuel injector is open, a small control current (holding current) is sufficient to keep the fuel injector open. With a constant valve-needle displacement, the injected fuel quantity is proportional to the injection duration (d) [5].

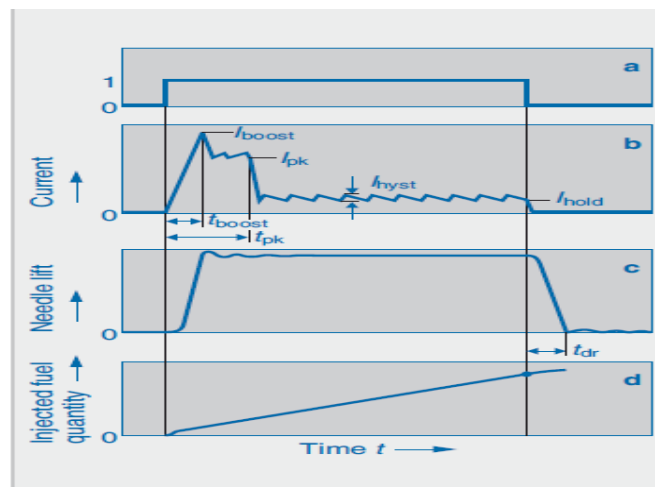

Figure 3.5: Actuation of high-pressure fuel injector

a. Triggering signal, b. Current curve in injector, c. Needle lift, d. Injected fuel quantity

### 3.2.3. Exhaust gas recirculation (EGR)

Exhaust Gas Recirculation (EGR) is widely used to reduce the exhaust emissions, particularly Nitrogen Oxides (NO<sub>x</sub>).

At high temperatures, the Nitrogen and Oxygen in the engine combustion chamber can chemically combine to form NO<sub>x</sub>,

When using higher EGR rates indicate a drastically reduction of NO<sub>x</sub>, especially with richer mixtures (about 60% NO<sub>x</sub> reduction). It was also observed an increase in specific

fuel consumption of about 8%, a reduction in an indicated mean effective pressure (about 15%) and a reduction in an engine cylinder maximum pressure of about 19%.

## **Chapter Four**

## **CH.4: Diesel Engine Management**

### **4.1. Engine Management System (EMS)**

Basic Engine Management System or EMS is a self-contained custom built computer which controls the running of an engine by monitoring the engine speed, load and temperature and metering the fuel to the engine in the exact quantity required. It is possible to run an engine management system which just provides one of these subsystems, for example just the injection system. It is much more common to use the mapped ignition within an Engine Management System.

### **4.2 Engine Management System operation**

The way the EMS manages injection is quite simple, the sensors and triggers on the engine relay information to the EMS about engine speed and load. The EMS uses these to extract the appropriate injector time from the Fuel MAP and then fires the injector(s) for this length of time. If the system uses batched injection then all of the injectors are fired at the same time once per engine revolution. With grouped injection the injectors are grouped together in pairs which are fired at an optimal point in the engines cycle which best suits those two cylinders, again once per revolution. The engine sensors are able to determine the engines cycle position (usually from a cam phase sensor) it is possible to fire the injectors at the optimum time for each individual cylinder; this is known as sequential injection. Rather than firing once per revolution, each injector is fired for twice the pulse width at the optimum time in the engines cycle; E.G. Immediately before the inlet valve opens. There are minor benefits in economy and emissions to be had from using sequential or grouped injection, but power wise there is little or no difference. As we can see information from these two main input sources allows the EMS to orchestrate the engines fueling so that the engine runs happily in normal conditions. There are times however when the engine is not running under these ideal conditions and it is at these

times that other vital feedback is required to allow the EMS to run the engine properly. Generally under these conditions the EMS makes adjustments or “corrections” to the fuel MAP according to what it knows about the prevailing conditions as will be explained in the following subsections.

#### **4.2.1. Engine temperature control**

When an engine starts from cold it is well below its normal operating temperature, this causes some of the fuel injected into the engine to condense rather than atomizing and being drawn inefficiently. Combustion chamber temperatures are also low which leads to incomplete and slow combustion. These effects cause the engine to run weak and require that extra fuel be supplied to the engine to compensate. On an injection system a coolant temperature sensor provides the EMS with the engines temperature and enables it to “correct” the fuelling. This correction involves adding a percentage of extra fuel according to a pre-determined correction profile by temperature, up to the normal operating temperature of the engine. The amount of extra fuel will vary from engine to engine and according to engines temperature and RPM since the effects of condensing are less when air speeds are higher.

#### **4.2.2. Cranking fuel control**

When the engine is actually being started the cranking speed is quite low (1500-2000 RPM or so) this means that the airspeed in the inlet ports is minimal and may not be sufficient to atomize and draw in all the fuel from the injectors. It is normally necessary to add some extra fuel while cranking to overcome this drawback. The amount of extra fuel to be added can be built into the base MAP at speed zero but it is more usual to have a correction to the base MAP which is a percentage of extra fuel to be added when cranking. This extra fueling can also vary with engine temperature so the correction is normally in a table for each of a range of engine temperatures. This correction normally decays quite quickly once the engine has fired since it is only required at low crank speeds. The percentage of extra fuel required will vary from engine to engine.

### **4.2.3. Idle speed control**

When an engine is idling and at normal temperature its airflow requirements are fairly constant and the ignition advance and the idle can be set at a constant rate. If any of the environmental conditions vary engine temperature, air density etc. Then the required airflow, ignition advance and fueling may need to vary in order to allow the engine to idle. In a carburetor based system there is often a fast idle which is set when the engine is cold which raises the idle speed to prevent stalling. Most EMS systems use an idle control system when the engine is idling; an Idle Air Control Valve (IACV) allows the air to the engine to be metered independently of the throttle butterfly. If the RPM falls below acceptable limits then more air is bled into the engine. If the RPM goes beyond an upper limit then less air is bled in. Together with fueling variation this system maintains a rock steady idle with acceptable emissions in all conditions whether the engine is hot or cold.

### **4.3. Diesel engine control**

To control a modern diesel engine you need to control:

Fuel injected quantity (IQ).

Fuel injection timing Start Of injection (SOI).

Fuel injection duration.

In order to control fuel injection you must know how much air is flowing into the engine and you must know the engine speed.

So you have four factors very closely linked.

1. Mass of Air Flowing (MAF)
2. Fuel Injected quantity (IQ)
3. Fuel injection duration
4. Engine speed (rpm)

### **4.4. Common-rail system (CRS)**

Common-rail (accumulator) fuel-injection systems make it possible to integrate the injection system together with a number of its extended functions in the diesel engine, and thus increase the degree of freedom available for defining the combustion process.

The common-rail system's principal feature is that injection pressure is independent of engine speed and injected fuel quantity.

The functions of pressure generation and injection are separated by an accumulator volume. This volume is the essential feature for the functioning of this system and is made up of volume components from the Common Rail itself, as well as from the fuel lines, and the injectors. The pressure is generated by a high-pressure plunger pump. An in-line pump is used in trucks and a radial-piston pump in passenger cars. The pump operates at low maximum torques and thus substantially reduces drive-power requirements. For the high-pressure pumps in passenger cars, the required fuel-rail pressure is regulated by a pressure-control valve mounted on the pump or the rail. High-pressure pumps in commercial vehicles have a fuel-quantity control system. The latest generation of high-pressure pumps for passenger-car use also has a fuel-quantity control system. This reduces the temperature of the fuel within the system. The system pressure generated by the high-pressure pump flows through a pressure-control circuit and is applied to the conventional injector. This injector serves as the core of this concept by ensuring correct fuel delivery into the combustion chamber. At a precisely defined instant the ECU transmits an activation signal to the injector solenoid to initiate fuel delivery. The injected fuel quantity is defined by the injector opening period and the system pressure.

#### **4.4.1. Fuel Injecting Quantity (I.Q)**

This is the job of the ECU it has to open the injector and close it which is done by an electrical pulse switching (on and off). The ECU will change how long the pulse lasts (Pulse Width Modulation PWM) to control the amount of fuel that exits the injector and goes into the cylinder.

The amount of fuel injected (I.Q) must be limited for two main reasons: enough air must be available (smoke limit) and smooth engine power must be produced to safe guard the power train (torque limit) .



#### **4.4.2. Start of Injection (SOI)**

The ECU must not only control the amount of fuel injected (I.Q) but also must control the time the fuel is injected into the cylinder to achieve the optimum time that produce the best explosion (power).

This timing determines when the injector will open and it is measured in degrees of crankshaft rotation Before Top Dead Centre BTDC. However, because the fuel flow is static and the engine speed is variable the time the piston travels up once becomes less this means we have to start the injection cycle sooner as the engine speed increases. This is called injection advance.

#### **4.4.3. Controlling the Pressure of Turbochargers.**

To get more air in we are going to put our airflow under pressure and that's the job of our turbocharger. So let's now talk about turbo and understand how they work. The turbo is going to put the air under pressure so that our air flow into the cylinder happens quicker, but as we have a fixed size of cylinder and because air speed will alter the end result is we can force more air into the cylinder. A turbo takes fresh air in and compresses it by using a turbine.

#### **4.4.4. Turbocharger boost control.**

Control for the solenoids and stepper motors can be either closed loop or open loop. Closed loop systems rely on feedback from a manifold pressure sensor to meet a predetermined boost pressure. Open loop systems have a predetermined control output where control output is merely based on other inputs such as throttle angle and/or engine RPM. Open loop specifically leaves out a desired boost level, while closed loop attempts to target a specific level of boost pressure. Since open loop systems do not modify control levels based on MAP sensor, differing boost pressure levels may be reached based on outside variables such as weather conditions or engine coolant temperature. For this reason, systems that do not feature closed loop operation are not as widespread.

Boost controllers often use Pulse Width Modulation (PWM) techniques to bleed off boost pressure on its way to the reference port on the waste gate (a device in a turbocharger that

regulates the pressure at which exhaust gases pass to the turbine by opening or closing a vent to the exterior) actuator diaphragm in such a way that the waste gate permits a turbocharger to build more boost pressure in the intake than it normally could. In effect, a boost-control solenoid valve lies to the waste gate under the Engine Control Unit's (ECU) control. The boost control solenoid contains a needle valve that can open and close very fast. By varying the pulse width to the solenoid, the solenoid valve can be commanded to be open a certain percentage of the time. This effectively alters the flow rate of air pressure through the valve. This effectively changes the air pressure as seen by the waste gate actuator diaphragm. Solenoids may require small diameter restrictors be installed in the air control lines to limit airflow and even out the on/off nature of their operation. The waste gate control solenoid can be commanded to run in a variety of frequencies in various gears, engine speeds in a deterministic open-loop mode. Or the waste gate control can be done by monitoring manifold pressure in a feedback loop. The engine management system can monitor the efficacy of PWM changes in the boost control solenoid bleed rate at altering boost pressure in the intake manifold, increasing or decreasing the bleed rate to target a particular maximum boost.

The basic algorithm sometimes involves the EMS (engine management system) "learning" how fast the turbocharger can spool and how fast the boost pressure increases. Armed with this knowledge, as long as boost pressure is below a predetermined allowable ceiling, the EMS will open the boost control solenoid to allow the turbocharger to create over boost beyond what the waste gate would normally allow. As over boost reaches the programmable maximum, the EMS begins to decrease the bleed rate through the control solenoid to raise boost pressure as seen at the waste gate actuator diaphragm so the waste gate opens enough to limit boost to the maximum configured level of over-boost.

## 4.5 Engine ECU MAP

### 4.5.1 Introduction of the ECU MAP

The ECU's input circuit converts incoming analog signals into digital form. The processor performs further operations with the input data in order to calculate output values with reference to the programmed data MAP. The output signals control several functions, including regulation of the servo elements that operate the choke valve and main throttle valve.

### 4.5.2 Devices for extracting the MAPs from the ECU

In order to extract the MAPs stored inside ECU, a special device could be used depending on the type of ECU in the vehicles and how the device extracts the MAPs:

- A. Direct mode: Is a type through which the MAPs are directly extracted by the On-board diagnostics (OBD) without the need to bring out the ECU from the vehicle.

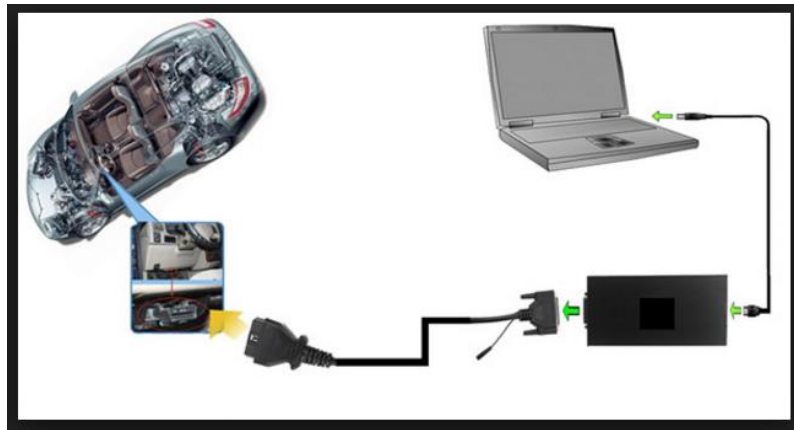

Figure 4. 1.KESS v2 device

For example KESSv2 (Master version) allows the complete access to the stock files located in the ECU. Once read and modified, the KESSv2 will allow rewriting (FLASH) the edited file back to the ECU.

- B. Indirect mode: Is a type through which the MAPs are indirectly extracted from the ECU after it has been removed from the vehicle, and mounted on Background Debug Mode (BDM) frame.

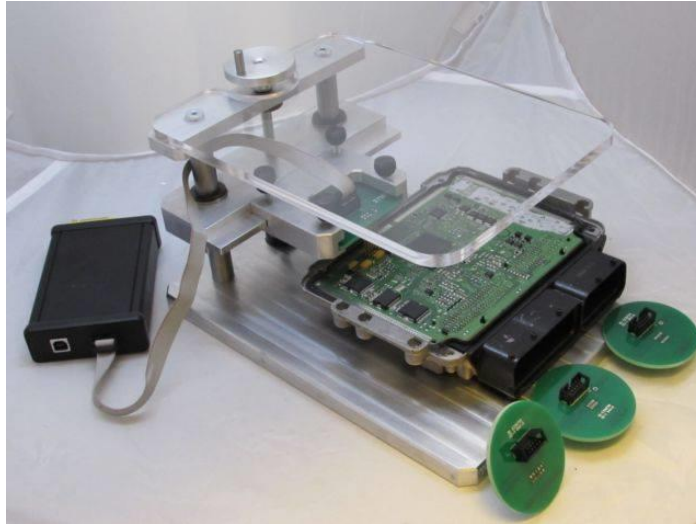

Figure 4.2: ECU into BDM frame

For example K-tag device used to read and write the ECU while on the BDM frame, each of the microprocessor, EEPROM, and flash memory can be accessed by connecting the tool to the ECU board.

#### **4. 5.3 Programs for reading ECU MAPs.**

WinOLS is an application, which is written especially to read the memory contents of ECU. It facilitates the searching and finding of MAPs, which can then be named and viewed in different ways. The MAP contents could be changed using different functions which are available to edit the MAPs within WinOLS software. A special plug-in utility for WinOLS software is used to identify the title of each ECU MAPs (damos). The MAPs inside WinOLS software could be viewed in different modes: hexadecimal (hex dump), graphical (2D, 3D) and text.

All data and MAPs are stored in project files. These project files hold all information obtained in the course of processing of a given controller. Other information, such as customer name, car number, and image files can be added.

Modifications of MAPs can be stored as 'versions' and can be commented. Up to 200 versions of one original file are possible.

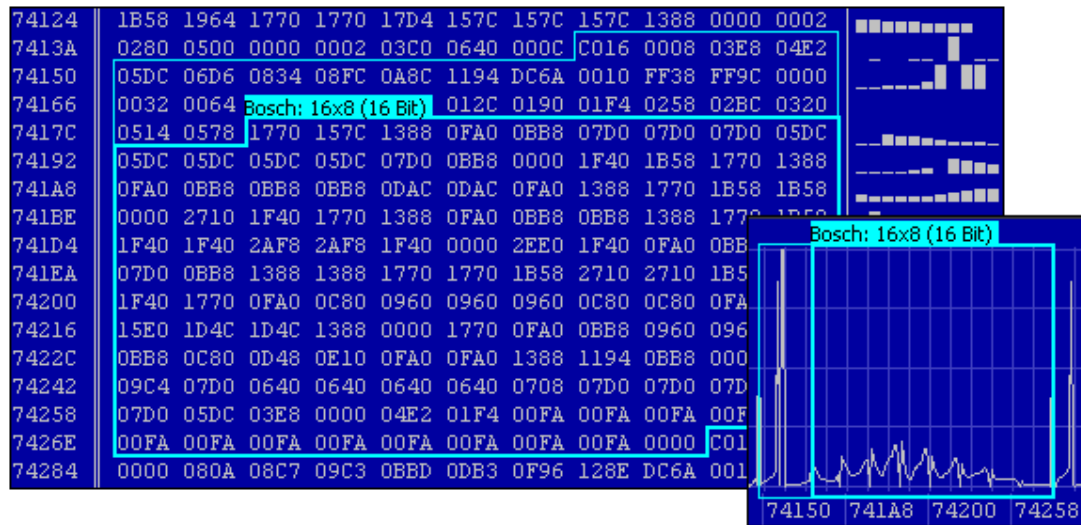

Figure 4.3: Map search in WinOLS

In this project we will use the KEES v2 device to extract the MAPs from the ECU and WinOLS software to read/view the MAPs.

## **Chapter Five**

## **CH.5: Case study (Fabia and Octavia)**

### **5.1. Case study procedure:**

As stated in the introduction of the project, the two vehicles ECUs (Octavia and Fabia) are compared based on the stored MAPs within the two ECUs, and the main differences are highlighted. The present case study is divided into two parts: In the first part we brought the two ECUs for the two vehicles (this is done in collaboration with a local company), and the KESS v2 device is used to extract the stored MAPs. In the second part of the project we used WinOLS software to view the MAPs in an understandable format and compare them.

### **5.2. All MAPs in Engine ECU:**

After reading the MAPs stored in the two ECUs of the Octavia and Fabia using the WinOLS software, a set of sixteen different MAPs are found in each ECU. The list below provides the name of the MAPs stored in the ECUs:

1. Driver wish.
2. EGR
3. Torque limit
4. Injection Quantity limited by MAF
5. Injection Quantity limited by MAP.
6. Lambda calculation.
7. Torque to Ignition Quantity conversion
8. Start Of Injection
9. SOI Selector
10. SOI Limiter
11. Duration selector
12. Duration
13. Boost control N75 Duty cycle
14. Boost pressure
15. Boost limit
16. Inverse driver wish

### **5.3. MAPs modified in the two Engine ECUs:**

After reading and comparing the sixteen MAPs in each ECU of Fabia and Octavia, we found that the change occurred only in seven MAPs:

1. Driver wish
2. Injection Quantity limit by mass air flow
3. Torque limit
4. Injection duration
5. Start Of Injection
6. Boost pressure
7. Boost limit
8. N75 duty cycle

The subsections below will highlight the differences in each MAP of the two ECUs.

#### **5.3.1: Driver Wish**

Table 5.1 shows the driver wish MAP for Fabia in text format, while Table 5.2 provides the driver wish MAP for Octavia. Table 5.3 provides the percentage differences between Fabia and Octavia MAP values calculated as the values of Octavia divided by the values for Fabia (i.e.  $I.Q \text{ Octavia} / I.Q \text{ Fabia}$ ). The black color means values are unchanged, red color means values are increased for Octavia, and blue color means values are decreased for Octavia (Note: this applies for all the subsequent tables).



Table 5.1: Driver wish for Fabia.

Z- IQ ( 0-70 ) mg/stroke		Accelerator pedal ( 0 - 100)%							
		1%	4%	10%	25%	37%	56%	80%	100%
rpm	<b>0</b>	18.7	41.9	46	54	61.7	68.9	70	70
	<b>399</b>	7.7	27.9	33.3	41.2	49.5	62.7	70	70
	<b>609</b>	0	19.6	25.8	34.7	43.6	59.1	70	70
	<b>693</b>	0	16	22.7	32	41.4	57.6	70	70
	<b>798</b>	0	11.4	19	28.2	37.6	56.3	70	70
	<b>903</b>	0	6.6	14.5	24.6	33.9	54.7	70	70
	<b>1008</b>	0	4.9	9	21	30.3	53.1	70	70
	<b>1113</b>	0	3.8	7	18.4	27.2	51.3	69	70
	<b>1218</b>	0	2.8	5.8	15.7	24.6	49.6	68	70
	<b>1491</b>	0	1.5	3.5	11.5	20.7	45.6	66	70
	<b>1995</b>	0	0.8	2.1	9	17	41.3	62	70
	<b>2499</b>	0	0.7	2	7.5	15	38.3	59.5	70
	<b>3003</b>	0	0.5	1.5	6.5	13	35.5	57.3	67.8
	<b>3990</b>	0	0	1	5	10.9	31.9	52.8	64.4
	<b>4998</b>	0	0	0	2.6	7.9	26.7	45.8	60
<b>5355</b>	0	0	0	0.5	1.1	20.5	29.5	45.5	

Table 5.2; Driver wish for Octavia

Z- IQ ( 0-70 ) mg/stroke		Accelerator pedal ( 0 - 100)%							
		1%	4%	10%	25%	37%	56%	80%	100%
rpm	<b>0</b>	18.7	41.9	46	54	61.7	68.9	70	70
	<b>399</b>	7.7	27.9	33.3	41.2	49.5	62.7	70	70
	<b>609</b>	0	19.6	25.8	34.7	43.6	59.1	70	70
	<b>693</b>	0	16	22.7	32	41.4	57.6	70	70
	<b>798</b>	0	11.4	19	28.2	37.6	56.3	70	70
	<b>903</b>	0	6.6	14.5	24.6	33.9	54.7	70	70
	<b>1008</b>	0	4.9	9	21	30.3	53.1	70	70
	<b>1113</b>	0	3.8	7	18.4	27.2	51.3	69	70
	<b>1218</b>	0	2.8	5.8	15.7	24.6	49.6	68	70
	<b>1491</b>	0	1.5	3.5	11.5	20.7	46.6	66	70
	<b>1995</b>	0	1	2.5	9	17	42.8	64	70
	<b>2499</b>	0	0.7	2	7.5	15	39.5	61.7	70
	<b>3003</b>	0	0.5	1.5	6.5	13	37.2	59.7	70
	<b>3990</b>	0	0	1	5	10.9	32.3	54.8	70
	<b>4998</b>	0	0	0	2.6	7.9	27.7	49.3	66
<b>5355</b>	0	0	0	0.5	1.1	22.6	32.5	50	

Table 5.3: Driver wish percentage difference between Octavia and Fabia.

(Z) I.Q percentage difference	Accelerator pedal (0 - 100)%									
		1%	4%	10%	25%	37%	56%	80%	100%	
<b>Engine Rpm</b>	<b>0</b>	1.00	1.00	1.00	1.00	1.00	1.00	1.00	1.00	
	<b>399</b>	1.00	1.00	1.00	1.00	1.00	1.00	1.00	1.00	
	<b>609</b>	1.00	1.00	1.00	1.00	1.00	1.00	1.00	1.00	
	<b>693</b>	1.00	1.00	1.00	1.00	1.00	1.00	1.00	1.00	
	<b>798</b>	1.00	1.00	1.00	1.00	1.00	1.00	1.00	1.00	
	<b>903</b>	1.00	1.00	1.00	1.00	1.00	1.00	1.00	1.00	
	<b>1008</b>	1.00	1.00	1.00	1.00	1.00	1.00	1.00	1.00	
	<b>1113</b>	1.00	1.00	1.00	1.00	1.00	1.00	1.00	1.00	
	<b>1218</b>	1.00	1.00	1.00	1.00	1.00	1.00	1.00	1.00	
	<b>1491</b>	1.00	1.00	1.00	1.00	1.00	1.00	1.02	1.00	1.00
	<b>1995</b>	1.00	1.25	1.19	1.00	1.00	1.00	1.04	1.03	1.00
	<b>2499</b>	1.00	1.00	1.00	1.00	1.00	1.00	1.03	1.04	1.00
	<b>3003</b>	1.00	1.00	1.00	1.00	1.00	1.00	1.05	1.04	1.03
	<b>3990</b>	1.00	1.00	1.00	1.00	1.00	1.00	1.01	1.04	1.09
<b>4998</b>	1.00	1.00	1.00	1.00	1.00	1.00	1.04	1.08	1.10	
<b>5355</b>	1.00	1.00	1.00	1.00	1.00	1.00	1.10	1.10	1.10	

The Injection Quantity (I.Q) output is increased up to 10% at the most usable power band (i.e. high pedal percentage request and high engine rpm); the reason for this increase is to allow for better acceleration performance in Octavia (which is heavier and longer compared with Fabia) which makes the car more responsive. However, both vehicles have the same fuel upper limit (I.Q) of 70 mg/stroke.

The other regions in the driver wish MAP remain unchanged since these regions cover the engine operation during cranking and Idling (which is identical for the same engine).

In order to make the engine works properly and increase the output power, the increase in fuel quantity (I.Q.) must be accompanied with an increase in the amount of air. The turbocharger pressure has to be increased in order to allow for more compressed air into the engine as will be seen later on. The value given in the driver wish MAP is not final because the ECU contains other limiting MAPs that limit the amount of fuel: smoke limit and torque limit MAPs.

### 5.3.2. Injection Quantity limit by mass air flow

This map is going to limit the amount of fuel actually injected by looking at the amount of air going into the engine. It is also known as smoke limit MAP because it regulates the

amount of black smoke (unburned fuel). Tables 5.4 - 5.5 show the smoke limit for Fabia and Octavia respectively, table 5.6 summarizes the percentage difference.

Table 5.4: Smoke limit for Fabia

Z-IQ mg/stroke	Mass Air Flow (MAF) (300 – 1051) mg/stroke													
	300	350	400	450	503	550	600	650	750	850	925	1050	1051	
Engine rpm	861	19.72	21.72	22.95	25.25	27.25	30	30.5	30.5	30.5	30.5	30.5	30.5	30.5
	924	19.6	20.67	22.7	25.75	28	32.75	35.75	36.75	38	38	38	38	38
	1008	19.25	20.25	22.45	25.02	28	32.52	35.75	39.25	42	42	42	42	41.5
	1260	18.1	19.07	21.25	23.5	26	29.5	33	37.5	42.5	47	47	47	47
	1491	17.25	18.43	20.68	23	25.3	27.62	30.2	34.6	40.28	46.53	51.75	52.75	52.75
	1743	17	18.5	20.4	22.5	24.5	26.92	29.4	33.65	39	44.9	51.5	58.75	58.75
	1995	17	18.4	20.3	22	24	26.32	28.95	33.35	38.23	44.06	50.5	59	59
	2247	17.1	18.6	20.2	21.8	23.9	26.2	29	33	38.2	43.68	49.75	58	58
	2499	17.2	18.75	20.3	21.8	23.75	26.15	28.75	32.75	38	43.65	49.5	57	57
	2751	17.5	18.75	20.25	21.6	23.75	25.95	28.75	32.75	37.85	43.5	49.25	55.75	55.75
	3003	17.5	18.75	20.3	21.65	23.75	25.9	28.8	32.75	38	43.66	49.25	55	55
	3255	17.5	18.7	20.25	21.65	23.75	26	28.85	32.75	38	43.82	49.57	54.75	54.75
	3507	17.5	18.75	20.1	21.5	23.75	26	29	32.75	38	43.82	49.57	54.75	54.75
	3759	17.2	18.75	19.95	21.5	23.75	26	29	32.75	38	43.98	49.57	54.75	54.75
4242	17	18.5	19.9	21.5	23.75	26	28.75	32.5	38	43.5	49	54.25	54.25	
5355	14.5	15.5	16.75	18.25	19.75	21.75	24.5	28	32.5	37.5	42.75	47.75	47.75	

Table 5.5: Smoke limit for Octavia

Z-IQ mg/stroke	Mass Air Flow (MAF) (300 – 1076) mg/stroke													
	300	350	400	450	503	550	600	650	750	850	925	1075	1076	
Engine rpm	861	21.75	23.75	25.7	27.25	29	30.5	30.5	30.5	30.5	30.5	30.5	30.5	30.5
	924	23	25.25	26.75	28.5	30.25	31.75	33	34.5	36	36.25	36.25	36.25	36.25
	1008	23.25	25.25	27	28.5	30.5	32.75	34.75	37.25	39.25	42	42	42	42
	1260	21	23.25	24.75	26.25	28.25	30.75	33.5	37.25	40.5	47.5	47.75	47.75	47.75
	1491	19.25	21	22.5	24.25	26.25	29.25	32	36.1	41	49	53.75	54	54
	1743	18	19.5	21.5	23.25	25.25	27.5	30.65	35	40	47.15	54.25	59.75	59.75
	1995	17.5	18.9	21	22.25	24.5	26.82	29.7	34.1	38.98	45.56	53	60	60
	2247	17.1	18.6	20.2	21.8	23.65	26.2	29.5	33.25	38.2	43.93	51.5	59.5	59.5
	2499	17.2	18.75	20.3	21.8	23.5	25.9	29	32.5	37.25	43.15	50	58.25	58.25
	2751	17.5	18.75	20.25	21.85	23.5	25.95	29	32.25	36.85	42.6	49	57.5	57.5
	3003	17.5	18.75	20.3	21.65	23.25	25.9	29.05	32.25	37	42.5	48.5	56.5	56.5
	3255	17.5	18.7	20.25	21.65	23.25	26	28.85	32.25	37	42.5	48.5	56.5	56.5
	3507	17.5	18.5	20.1	21.5	23.25	26	29.25	32.25	37	42.5	48.5	56.5	56.5
	3759	17.2	18.5	19.95	21.5	23.25	25.75	29	32.25	37	42.5	48.5	56.5	56.5
4242	16.75	18	19.4	21	22.75	25.5	28.75	32	36.75	42.5	48.5	56.5	56.5	
5355	14.5	15.5	16.75	18	19.5	21.5	24.5	28	32	37.5	43	51	51	

Table 5.6: Smoke limit percentage difference between Fabia and Octavia

Z-IQ percentage difference		Mass Air Flow (MAF) (300 – 925) mg/stroke										
		300	350	400	450	503	550	600	650	750	850	925
Engine rpm	861	1.10	1.09	1.12	1.08	1.06	1.02	1.00	1.00	1.00	1.00	1.00
	924	1.17	1.22	1.18	1.11	1.08	0.97	0.92	0.94	0.95	0.95	0.95
	1008	1.21	1.25	1.20	1.14	1.09	1.01	0.97	0.95	0.93	1.00	1.00
	1260	1.16	1.22	1.16	1.12	1.09	1.04	1.02	0.99	0.95	1.01	1.02
	1491	1.12	1.14	1.09	1.05	1.04	1.06	1.06	1.04	1.02	1.05	1.04
	1743	1.06	1.05	1.05	1.03	1.03	1.02	1.04	1.04	1.03	1.05	1.05
	1995	1.03	1.03	1.03	1.01	1.02	1.02	1.03	1.02	1.02	1.03	1.05
	2247	1.00	1.00	1.00	1.00	0.99	1.00	1.02	1.01	1.00	1.01	1.04
	2499	1.00	1.00	1.00	1.00	0.99	0.99	1.01	0.99	0.98	0.99	1.01
	2751	1.00	1.00	1.00	1.01	0.99	1.00	1.01	0.98	0.97	0.98	0.99
	3003	1.00	1.00	1.00	1.00	0.98	1.00	1.01	0.98	0.97	0.97	0.98
	3255	1.00	1.00	1.00	1.00	0.98	1.00	1.00	0.98	0.97	0.97	0.98
	3507	1.00	0.99	1.00	1.00	0.98	1.00	1.01	0.98	0.97	0.97	0.98
	3759	1.00	0.99	1.00	1.00	0.98	0.99	1.00	0.98	0.97	0.97	0.98
	4242	0.99	0.97	0.97	0.98	0.96	0.98	1.00	0.98	0.97	0.98	0.99
5355	1.00	1.00	1.00	0.99	0.99	0.99	1.00	1.00	0.98	1.00	1.01	

The main change in smoke limit MAP is focused in the low-medium air flow and engine rpm with a percentage increase up to 25%. This region covers engine operation during cranking and idling, therefore, Octavia is expected to have a rock steady idle, however, with emissions higher than Fabia. It is important to mention that in Octavia the mass air flow may reach up to (1076 mg/stroke) compared with (1060 mg/stroke) in Fabia. Also, the maximum amount of fuel (I.Q) provided by the driver wish MAP (70 mg/stroke) is limited by smoke limit MAP into (60 mg/stroke).

### 5.3.3 Torque Limit

This MAP limits the fuel quantity injected based on engine rpm and atmospheric pressure. It is designed to protect the entire power train (from engine to tires) by limiting the actual beneficial power at given engine rpm. Tables 5.7 - 5.8 show the torque limit for Fabia and Octavia respectively, table 5.9 summarizes the percentage difference between Octavia and Fabia.

Since there is no point in having a higher I.Q below 2000 rpm as their will not be enough air available; the main change in MAP values is focused in the medium to high engine

rpm with a percentage increase up to 15%. This region covers engine operation during acceleration and cruising, therefore at a given engine rpm, Octavia is expected to have a responsive power shift compared with slower power shift in Fabia. The maximum amount of fuel (I.Q) provided by the driver wish MAP (70 mg/stroke) is limited by torque limit MAP into a maximum of about (57 mg/stroke).

Table 5.7: Torque Limit for Fabia

<b>z- IQ</b> mg/stroke		<b>Engine rpm. (551 – 2499 rpm)</b>								
		<b>551</b>	<b>1000</b>	<b>1250</b>	<b>1500</b>	<b>1750</b>	<b>1900</b>	<b>2016</b>	<b>2247</b>	<b>2499</b>
Atmospheric Air Pressure (850 - 1000 mbar)	<b>850</b>	30.50	30.50	40.00	48.00	54.00	56.00	55.00	53.50	52.50
	<b>900</b>	30.50	30.50	40.00	48.00	54.00	56.00	55.00	53.50	52.50
	<b>1000</b>	30.50	30.50	40.00	48.00	54.00	56.00	55.00	53.50	52.50
<b>z- IQ</b> mg/stroke		<b>Engine rpm. (2750– 4800 rpm)</b>								
		<b>2750</b>	<b>3000</b>	<b>3250</b>	<b>3500</b>	<b>3750</b>	<b>4000</b>	<b>4250</b>	<b>4500</b>	<b>4800</b>
Atmospheric Air Pressure (850 - 1000 mbar)	<b>850</b>	51.50	51.00	50.00	49.25	48.00	47.00	44.00	39.00	32.00
	<b>900</b>	51.50	51.00	50.00	49.25	48.00	47.00	44.00	39.00	32.00
	<b>1000</b>	51.50	51.00	50.00	49.25	48.00	47.00	44.00	39.00	32.00

Table 5.8: Torque Limit for Octavia.

<b>z- IQ</b> mg/stroke		<b>Engine rpm. (551 – 2499 rpm)</b>								
		<b>551</b>	<b>1000</b>	<b>1250</b>	<b>1500</b>	<b>1750</b>	<b>1900</b>	<b>2016</b>	<b>2247</b>	<b>2499</b>
Atmospheric Air Pressure (850 - 1000 mbar)	<b>850</b>	30.00	30.00	37.00	48.00	53.50	56.00	55.50	54.50	54.00
	<b>900</b>	30.00	30.00	37.00	48.00	53.50	57.50	56.50	55.50	54.50
	<b>1000</b>	30.00	30.00	37.00	48.00	53.50	57.50	56.50	55.50	54.50
<b>z- IQ</b> mg/stroke		<b>Engine rpm. (2750– 4800 rpm)</b>								
		<b>2750</b>	<b>3000</b>	<b>3250</b>	<b>3500</b>	<b>3750</b>	<b>4000</b>	<b>4250</b>	<b>4500</b>	<b>4800</b>
Atmospheric Air Pressure (850 - 1000 mbar)	<b>850</b>	54.00	54.00	54.00	54.00	54.00	54.00	48.50	43.00	33.00
	<b>900</b>	54.00	54.00	54.00	54.00	54.00	54.00	48.50	43.00	33.00
	<b>1000</b>	54.00	54.00	54.00	54.00	54.00	54.00	48.50	43.00	33.00

Table 5.9: Torque Limit percentage difference between Octavia and Fabia.

<b>(Z) IQ percentage difference</b>		<b>Engine rpm. (551– 2499 rpm)</b>								
		<b>551</b>	<b>1000</b>	<b>1250</b>	<b>1500</b>	<b>1750</b>	<b>1900</b>	<b>2016</b>	<b>2247</b>	<b>2499</b>
Atmospheric	<b>850</b>	0.98	0.98	0.93	1.00	0.99	1.00	1.01	1.02	1.03
Air Pressure	<b>900</b>	0.98	0.98	0.93	1.00	0.99	1.03	1.03	1.04	1.04
(850 - 1000 mbar)	<b>1000</b>	0.98	0.98	0.93	1.00	0.99	1.03	1.03	1.04	1.04
<b>(Z) IQ percentage difference</b>		<b>Engine rpm. (2750– 4800 rpm)</b>								
		<b>2750</b>	<b>3000</b>	<b>3250</b>	<b>3500</b>	<b>3750</b>	<b>4000</b>	<b>4250</b>	<b>4500</b>	<b>4800</b>
Atmospheric	<b>850</b>	1.05	1.06	1.08	1.10	1.13	1.15	1.10	1.10	1.03
Air Pressure	<b>900</b>	1.05	1.06	1.08	1.10	1.13	1.15	1.10	1.10	1.03
(850 - 1000 mbar)	<b>1000</b>	1.05	1.06	1.08	1.10	1.13	1.15	1.10	1.10	1.03

### 5.3.4 Injection duration:

Injection duration is a key element in fuel amount (I.Q), since this MAP is not modified by other limiting MAPs. The injection duration MAPs specify the time of injection in milliseconds, this done by controlling the PWM of the injector signal. In the comparison between Octavia and Fabia six different injection duration MAPs are found (duration 0 – duration 5), however, these MAPs are identical in the two vehicles as illustrated in Tables 5.10-5.12 for duration 0 MAP.

Table 5.10: Injection duration 0 for Fabia.

<b>(Z) Injection duration milliseconds</b>		<b>Injection Quantity I.Q mg/stroke</b>									
		8	10	15	20	30	35	38	40	45	50
Engine rpm	1000	266	266	266	266	266	266	266	266	266	266
	1500	266	266	266	266	266	266	266	266	266	266
	2000	266	266	266	266	266	266	266	266	266	266
	2500	266	266	266	266	266	266	266	266	266	266
	3000	266	266	266	266	266	266	266	266	266	266
	3500	266	266	266	266	266	266	266	266	266	266
	4000	266	266	266	266	266	266	266	266	266	266
	4500	266	266	266	266	266	266	266	266	266	266
	5000	266	266	266	266	266	266	266	266	266	266
	5500	266	266	266	266	266	266	266	266	266	266

Table 5.11: Injection duration 0 for Octavia.

<b>(Z) Injection duration milliseconds</b>		<b>Injection Quantity I.Q mg/stroke</b>									
		8	10	15	20	30	35	38	40	45	50
Engine rpm	1000	266	266	266	266	266	266	266	266	266	266
	1500	266	266	266	266	266	266	266	266	266	266
	2000	266	266	266	266	266	266	266	266	266	266
	2500	266	266	266	266	266	266	266	266	266	266
	3000	266	266	266	266	266	266	266	266	266	266
	3500	266	266	266	266	266	266	266	266	266	266
	4000	266	266	266	266	266	266	266	266	266	266
	4500	266	266	266	266	266	266	266	266	266	266
	5000	266	266	266	266	266	266	266	266	266	266
	5500	266	266	266	266	266	266	266	266	266	266



Table 5.12: Injection duration 0 percentage difference between Octavia and Fabia.

(Z) Injection duration percentage difference		Injection Quantity I.Q mg/stroke									
		8	10	15	20	30	35	38	40	45	50
Engine rpm	1000	1.00	1.00	1.00	1.00	1.00	1.00	1.00	1.00	1.00	1.00
	1500	1.00	1.00	1.00	1.00	1.00	1.00	1.00	1.00	1.00	1.00
	2000	1.00	1.00	1.00	1.00	1.00	1.00	1.00	1.00	1.00	1.00
	2500	1.00	1.00	1.00	1.00	1.00	1.00	1.00	1.00	1.00	1.00
	3000	1.00	1.00	1.00	1.00	1.00	1.00	1.00	1.00	1.00	1.00
	3500	1.00	1.00	1.00	1.00	1.00	1.00	1.00	1.00	1.00	1.00
	4000	1.00	1.00	1.00	1.00	1.00	1.00	1.00	1.00	1.00	1.00
	4500	1.00	1.00	1.00	1.00	1.00	1.00	1.00	1.00	1.00	1.00
	5000	1.00	1.00	1.00	1.00	1.00	1.00	1.00	1.00	1.00	1.00
	5500	1.00	1.00	1.00	1.00	1.00	1.00	1.00	1.00	1.00	1.00

### 5.3.5. Start of Injection (SOI)

This is the most important MAP; it determines the start of injection expressed in degrees of crank shaft rotation Before Top Dead Center (BTDC). This MAP directly affects engine detonation (life).

In the comparison between Octavia and Fabia ten different Start Of Injection MAPs are found (SOI 0 – SOI 9), however, these MAPs are identical in the two vehicles as illustrated in Tables 5.13-5.15 for SOI 0 MAP. The unique difference is that in Octavia the Injection Quantity (I.Q) may reach up to 60 mg/stroke compared with 55 mg/stroke in Fabia.

Table 5.13: Start of Injection SOI 0 for Fabia

(Z) Crankshaft Rotation		I.Q mg/stroke													
		0	5	7.5	10	15	20	22.5	25	30	35	40	45	50	55
engine rpm	100	2901	2901	2901	2901	2901	2901	2901	2901	2901	2987	2987	2987	2987	2987
	400	2901	2901	2901	2901	2901	2901	2901	2901	2901	2688	2688	2688	2688	2688
	800	2901	2901	2901	2901	2901	2901	2901	2901	2901	2688	2688	2688	2688	2688
	1000	2901	2901	2901	2901	2901	2901	2901	2901	2901	2688	2688	2688	2688	2688
	1250	2901	2901	2901	2901	2901	2901	2901	2901	2901	2688	2688	2688	2688	2688
	1500	2901	2901	2901	2901	2901	2901	2901	2901	2855	2855	2855	2848	2837	2837
	1750	2901	2901	2901	2901	2901	2901	2901	2901	2901	2893	2870	2848	2837	2837
	2000	2901	2901	2901	2901	2901	2901	2901	2901	2901	2881	2848	2826	2806	2806
	2250	2901	2901	2901	2901	2901	2901	2890	2868	2849	2816	2795	2773	2773	2773
	2500	2901	2901	2901	2901	2901	2881	2854	2826	2806	2773	2751	2730	2730	2730
	2750	2901	2901	2901	2901	2901	2843	2814	2785	2757	2724	2702	2676	2676	2676
	3000	2901	2901	2901	2901	2857	2796	2770	2743	2710	2678	2649	2624	2624	2624
	3500	2869	2869	2869	2816	2754	2705	2681	2658	2618	2581	2549	2495	2495	2495
	4000	2795	2795	2795	2732	2667	2615	2595	2574	2530	2497	2389	2378	2378	2378
4250	2753	2753	2753	2693	2629	2573	2552	2531	2488	2455	2325	2325	2325	2325	
5000	2636	2636	2636	2572	2505	2450	2427	2403	2359	2315	2228	2228	2228	2228	

Table 5.14: Start of Injection SOI 0 for Octavia

(Z) Crankshaft rotation		I.Q mg/stroke													
		0	5	10	15	20	25	27.5	30	35	40	45	50	55	60
engine rpm	100	2901	2901	2901	2901	2901	2901	2901	2901	2901	2987	2987	2987	2987	2987
	400	2901	2901	2901	2901	2901	2901	2901	2901	2901	2688	2688	2688	2688	2688
	800	2901	2901	2901	2901	2901	2901	2901	2901	2901	2688	2688	2688	2688	2688
	1000	2901	2901	2901	2901	2901	2901	2901	2901	2901	2688	2688	2688	2688	2688
	1250	2901	2901	2901	2901	2901	2901	2901	2901	2901	2688	2688	2688	2688	2688
	1500	2901	2901	2901	2901	2901	2901	2901	2901	2855	2855	2855	2848	2837	2837
	1750	2901	2901	2901	2901	2901	2901	2901	2901	2901	2893	2870	2848	2837	2837
	2000	2901	2901	2901	2901	2901	2901	2901	2901	2901	2881	2848	2826	2806	2806
	2250	2901	2901	2901	2901	2901	2901	2890	2868	2849	2816	2795	2773	2773	2773
	2500	2901	2901	2901	2901	2901	2881	2854	2826	2806	2773	2751	2730	2730	2730
	2750	2901	2901	2901	2901	2901	2843	2814	2785	2757	2724	2702	2676	2676	2676
	3000	2901	2901	2901	2901	2857	2796	2770	2743	2710	2678	2649	2624	2624	2624
	3500	2869	2869	2869	2816	2754	2705	2681	2658	2618	2581	2549	2495	2495	2495
	4000	2795	2795	2795	2732	2667	2615	2595	2574	2530	2497	2389	2378	2378	2378
4250	2753	2753	2753	2693	2629	2573	2552	2531	2488	2455	2325	2325	2325	2325	
5000	2636	2636	2636	2572	2505	2450	2427	2403	2359	2315	2228	2228	2228	2228	

Table 5.15: Start of injection SOI 0 Percentage Differences between Octavia and Fabia.

(Z) Crankshaft Rotation percentage difference		I.Q mg/stroke													
		0	5	7.5	10	15	20	22.5	25	30	35	40	45	50	55
<b>Engine rpm</b>	<b>100</b>	1.00	1.00	1.00	1.00	1.00	1.00	1.00	1.00	1.00	1.00	1.00	1.00	1.00	1.00
	<b>400</b>	1.00	1.00	1.00	1.00	1.00	1.00	1.00	1.00	1.00	1.00	1.00	1.00	1.00	1.00
	<b>800</b>	1.00	1.00	1.00	1.00	1.00	1.00	1.00	1.00	1.00	1.00	1.00	1.00	1.00	1.00
	<b>1000</b>	1.00	1.00	1.00	1.00	1.00	1.00	1.00	1.00	1.00	1.00	1.00	1.00	1.00	1.00
	<b>1250</b>	1.00	1.00	1.00	1.00	1.00	1.00	1.00	1.00	1.00	1.00	1.00	1.00	1.00	1.00
	<b>1500</b>	1.00	1.00	1.00	1.00	1.00	1.00	1.00	1.00	1.00	1.00	1.00	1.00	1.00	1.00
	<b>1750</b>	1.00	1.00	1.00	1.00	1.00	1.00	1.00	1.00	1.00	1.00	1.00	1.00	1.00	1.00
	<b>2000</b>	1.00	1.00	1.00	1.00	1.00	1.00	1.00	1.00	1.00	1.00	1.00	1.00	1.00	1.00
	<b>2250</b>	1.00	1.00	1.00	1.00	1.00	1.00	1.00	1.00	1.00	1.00	1.00	1.00	1.00	1.00
	<b>2500</b>	1.00	1.00	1.00	1.00	1.00	1.00	1.00	1.00	1.00	1.00	1.00	1.00	1.00	1.00
	<b>2750</b>	1.00	1.00	1.00	1.00	1.00	1.00	1.00	1.00	1.00	1.00	1.00	1.00	1.00	1.00
	<b>3000</b>	1.00	1.00	1.00	1.00	1.00	1.00	1.00	1.00	1.00	1.00	1.00	1.00	1.00	1.00
	<b>3500</b>	1.00	1.00	1.00	1.00	1.00	1.00	1.00	1.00	1.00	1.00	1.00	1.00	1.00	1.00
	<b>4000</b>	1.00	1.00	1.00	1.00	1.00	1.00	1.00	1.00	1.00	1.00	1.00	1.00	1.00	1.00
	<b>4250</b>	1.00	1.00	1.00	1.00	1.00	1.00	1.00	1.00	1.00	1.00	1.00	1.00	1.00	1.00
<b>5000</b>	1.00	1.00	1.00	1.00	1.00	1.00	1.00	1.00	1.00	1.00	1.00	1.00	1.00	1.00	

### 5.3.6 Turbocharger MAPs

The Turbocharger MAPs consist of four MAPs.

1. Turbocharger boost pressure MAP
2. Turbocharger boost limiting MAP.
3. Turbocharger Control Valve (N75 % Duty Cycle) MAP.

#### 5.3.6.1 Turbocharger Boost Pressure.

The boost MAP determines the boost pressure based on fuel amount (I.Q) and engine rpm as illustrated in Tables 5.16 - 5.17 for Fabia and Octavia respectively. Table 5.18 summarizes the percentage difference between Octavia and Fabia. It is important to mention that in Octavia the fuel amount may reach up to 55 mg/stroke compared with 50 mg/stroke in Fabia.

Most of the boost changes occur in medium to high engine rpm which is the area of interest for turbo charger operation (2000-4000 engine rpm). The percentage difference within this region is about 2%. The maximum boost pressure in Fabia of 2350 mbar is raised to a maximum of 2500 mbar in the Octavia; however, this maximum boost pressure is always associated with the maximum fuel amount (I.Q). It is important to

mention that the value given in the boost MAP is not final, since another MAP controls the amount of final pressure (boost limiting MAP).

Table 5.16: Boost pressure for fabia

Boost pressure. (0 – 2350 mbar)		(I.Q) - (0 - 50) mg/stroke									
		0	5	10	15	20	25	30	35	45	50
Engine rpm	21	1002	1052	1102	1158	1195	1265	1350	1350	1350	1350
	1008	1002	1058	1106	1153	1199	1265	1350	1350	1350	1350
	1260	1002	1060	1119	1171	1225	1281	1373	1500	1750	1750
	1500	1002	1090	1155	1225	1305	1380	1495	1650	1900	2000
	1750	1002	1115	1195	1280	1365	1475	1610	1800	2050	2250
	1900	1002	1130	1210	1310	1395	1515	1660	1860	2115	2300
	2000	1002	1140	1220	1320	1415	1535	1685	1880	2155	2325
	2247	1012	1160	1240	1340	1440	1565	1705	1915	2205	2350
	2499	1021	1180	1260	1360	1460	1585	1725	1925	2210	2350
	3500	1060	1225	1320	1425	1525	1645	1775	1965	2235	2350
	3750	1080	1225	1330	1435	1530	1645	1780	1970	2235	2350
	3990	1100	1225	1330	1445	1540	1650	1780	1970	2215	2320
	4250	1120	1225	1330	1445	1540	1650	1780	1980	2170	2260
	4494	1149	1225	1328	1445	1540	1645	1780	1965	2070	2140
	4746	1200	1225	1325	1429	1530	1655	1775	1900	1950	1950

Table 5.17: Boost pressure for Octavia

Boost pressure. (0 – 2500 mbar)		(I.Q) - (0 - 55) mg/stroke									
		0	5	10	15	20	25	30	35	45	55
Engine rpm	21	1002	1052	1092	1158	1205	1265	1350	1350	1350	1350
	1008	1002	1048	1096	1153	1199	1265	1350	1350	1350	1350
	1260	1002	1065	1114	1166	1220	1276	1353	1405	1500	1575
	1500	1002	1095	1170	1230	1310	1395	1470	1595	1750	1900
	1750	1002	1120	1220	1305	1390	1490	1600	1755	1950	2200
	1900	1002	1135	1245	1335	1420	1525	1645	1825	2050	2350
	2000	1002	1145	1255	1355	1440	1545	1660	1855	2100	2400
	2247	1012	1165	1275	1375	1465	1575	1695	1895	2145	2475
	2499	1021	1175	1285	1385	1485	1595	1715	1915	2160	2500
	3500	1075	1230	1325	1435	1540	1650	1770	1975	2215	2500
	3750	1095	1230	1335	1445	1555	1670	1785	1980	2215	2500
	3990	1115	1240	1345	1445	1565	1675	1790	1980	2215	2455
	4250	1150	1240	1355	1445	1565	1675	1800	1980	2200	2355
	4494	1154	1250	1353	1445	1565	1680	1800	1970	2150	2240
	4746	1150	1250	1350	1429	1555	1680	1805	1950	2050	2100

Table 5.18: Boost pressure percentag difference between Octavia and Fabia

(Z) boost pressure percentage difference		(I.Q) - (0 - 45)								
		0	5	10	15	20	25	30	35	45
Engine rpm	0	1.00	1.00	1.00	1.00	1.00	1.00	1.00	1.00	1.00
	21	1.00	1.00	0.99	1.00	1.01	1.00	1.00	1.00	1.00
	1008	1.00	0.99	0.99	1.00	1.00	1.00	1.00	1.00	1.00
	1260	1.00	1.00	1.00	1.00	1.00	1.00	0.99	0.94	0.86
	1500	1.00	1.00	1.01	1.00	1.00	1.01	0.98	0.97	0.92
	1750	1.00	1.00	1.02	1.02	1.02	1.01	0.99	0.98	0.95
	1900	1.00	1.00	1.03	1.02	1.02	1.01	0.99	0.98	0.97
	2000	1.00	1.00	1.03	1.03	1.02	1.01	0.99	0.99	0.97
	2247	1.00	1.00	1.03	1.03	1.02	1.01	0.99	0.99	0.97
	2499	1.00	1.00	1.02	1.02	1.02	1.01	0.99	0.99	0.98
	3500	1.01	1.00	1.00	1.01	1.01	1.00	1.00	1.01	0.99
	3750	1.01	1.00	1.00	1.01	1.02	1.02	1.00	1.01	0.99
	3990	1.01	1.01	1.01	1.00	1.02	1.02	1.01	1.01	1.00
	4250	1.03	1.01	1.02	1.00	1.02	1.02	1.01	1.00	1.01
	4494	1.00	1.02	1.02	1.00	1.02	1.02	1.01	1.00	1.04
4746	0.96	1.02	1.02	1.00	1.02	1.02	1.02	1.03	1.05	

**5.3.6.2. Boost Limiting MAP.**

Boost limiting MAP determines the limiting value of the boost pressure when the atmospheric air pressure is different from ideal (ideal is taken as 1000 mbar). At low air pressure, the air is thinner so the turbocharger cannot compress enough air and will spin too fast as it tries, which will damage the turbocharger bearings.

Tables 5.19 - 5.20 show the boost limiting MAP for Fabia and Octavia respectively. Table 5.21 summarizes the percentage difference between Octavia and Fabia. The percentage difference chart shows that the Octavia allows slightly higher boost limit at middle to high rpm (up to 6%), so the Octavia is slightly less turbo limiting. Therefore, Octavia is expected to have better performance at turbo conditions.

Table 5. 19.Boost Limiting MAP for Fabia

<b>Boost pressure. (0 – 2400 mbar)</b>		<b>Engine rpm</b>									
		<b>1490</b>	<b>1743</b>	<b>1911</b>	<b>2247</b>	<b>2499</b>	<b>3003</b>	<b>3507</b>	<b>3990</b>	<b>4242</b>	<b>4494</b>
Atmospheric Air Pressure	<b>600</b>	1600	1900	1950	1975	1975	1975	1925	1750	1650	1550
	<b>650</b>	1650	1950	2000	2025	2025	2025	1975	1825	1725	1625
	<b>700</b>	1700	2000	2050	2075	2075	2075	2025	1875	1775	1675
	<b>750</b>	1750	2050	2100	2125	2125	2125	2075	1910	1815	1715
	<b>800</b>	1800	2100	2150	2185	2200	2200	2150	2005	1905	1805
	<b>850</b>	1850	2150	2200	2225	2240	2240	2225	2085	2000	1900
	<b>900</b>	1900	2200	2250	2275	2275	2275	2275	2200	2100	2000
	<b>950</b>	1950	2250	2300	2350	2350	2350	2350	2300	2225	2125
	<b>975</b>	2000	2300	2350	2400	2400	2400	2400	2350	2275	2175
<b>1100</b>	2000	2300	2350	2400	2400	2400	2400	2350	2275	2175	

Table 5. 20.Boost Limiting MAP for Octavia

<b>(Z)-Boost pressure. (0 – 2500 mbar)</b>		<b>Engine rpm</b>									
		<b>1490</b>	<b>1743</b>	<b>1911</b>	<b>2247</b>	<b>2499</b>	<b>3003</b>	<b>3507</b>	<b>3990</b>	<b>4242</b>	<b>4494</b>
Atmospheric Air Pressure	<b>600</b>	1500	1800	1935	2075	2090	2045	1885	1730	1650	1575
	<b>650</b>	1550	1850	1990	2125	2140	2100	1940	1780	1700	1620
	<b>700</b>	1600	1900	2040	2175	2205	2180	2020	1860	1775	1695
	<b>750</b>	1650	1950	2090	2225	2250	2240	2080	1930	1855	1780
	<b>800</b>	1700	2000	2140	2275	2300	2300	2150	2000	1925	1840
	<b>850</b>	1775	2075	2205	2325	2350	2350	2240	2110	2035	1950
	<b>900</b>	1825	2125	2250	2375	2400	2400	2335	2220	2150	2070
	<b>950</b>	1880	2175	2305	2425	2450	2450	2450	2400	2330	2250
	<b>975</b>	1900	2200	2350	2475	2500	2500	2500	2450	2380	2300
<b>1000</b>	1900	2200	2350	2475	2500	2500	2500	2500	2430	2300	

Table 5. 21. Boost Limiting MAP percentage difference between Octavia and Fabia

<b>(Z)- Boost pressure percentage difference</b>		<b>Engine rpm</b>									
		<b>1490</b>	<b>1743</b>	<b>1911</b>	<b>2247</b>	<b>2499</b>	<b>3003</b>	<b>3507</b>	<b>3990</b>	<b>4242</b>	<b>4494</b>
Atmospheric Air Pressure	<b>600</b>	0.94	0.95	0.99	1.05	1.06	1.04	0.98	0.99	1.00	1.02
	<b>650</b>	0.94	0.95	1.00	1.05	1.06	1.04	0.98	0.98	0.99	1.00
	<b>700</b>	0.94	0.95	1.00	1.05	1.06	1.05	1.00	0.99	1.00	1.01
	<b>750</b>	0.94	0.95	1.00	1.05	1.06	1.05	1.00	1.01	1.02	1.04
	<b>800</b>	0.94	0.95	1.00	1.04	1.05	1.05	1.00	1.00	1.01	1.02
	<b>850</b>	0.96	0.97	1.00	1.04	1.05	1.05	1.01	1.01	1.02	1.03
	<b>900</b>	0.96	0.97	1.00	1.04	1.05	1.05	1.03	1.01	1.02	1.04
<b>950</b>	0.96	0.97	1.00	1.03	1.04	1.04	1.04	1.04	1.05	1.06	

### **5.3.6.3 Turbocharger Control Valve MAP. (N75 % Duty Cycle)**

N75 Solenoid valve: This is the electronic boost controller that the ECU uses to manage boost in the system. The N75 is connected to the waste gate actuator (which controls the bypass movement of the exhaust gases inside the turbo housing). N75 duty cycle MAP is very critical since it prevent the turbo charger from explosion due to high pressure build up in turbo charger casing.

N75's duty cycle determines the boost duty; this is a value from 0% to 100%. When the N75 duty cycle is 0%, the waste gate actuator is opening 100% thus the exhaust gases are bypassed and no boost pressure is built. On the other hand, when N75 duty cycle is 100%, the waste gate actuator is completely closed thus all exhaust gases are directed toward the turbine to build up boost pressure.

The N75 duty cycle is normally set between 80-95% at idle such that the turbo is set to give the maximum boost since the exhaust gases flow is low. At higher engine rpm the N75 duty cycle is normally set between 20-25% in order to protect the turbo from the high exhaust gases flow out from the engine. Tables 5.22 - 5.23 show the N75 duty cycle MAP for Fabia and Octavia respectively. Table 5.24 summarizes the percentage difference between Octavia and Fabia.

There is a little difference below 1500 rpm as the turbocharger is not working even though it is set for maximum boost 80%, above 1500 rpm the differences become more evident. In general Octavia N75 duty cycle MAP is set to provide more boost compared with Fabia; a maximum percentage increase of 36% in N75 duty cycle is found between Octavia and Fabia (duty cycle of 31.9% in Fabia to a duty cycle 43.4% in Octavia).

Table 5.22: N75 Duty Cycle for Fabia

(Z) N75 duty cycle		(I.Q) (0 - 58) mg/stroke												
		0	5	10	15	20	25	30	35	40	45	50	55	58
engine rpm	760	75	75	75	80	80	80	80	80	80	80	80	80	80
	780	75	75	75	80	80	80	80	80	80	80	80	80	80
	1000	75	75	75	80	80	80	80	80	80	80	80	80	80
	1150	75	75	75	80	80	80	80	80	80	80	80	80	80
	1300	72	72	72	72	72	72	69	65	62	60	60	60	60
	1500	66	66	66	62.7	59.7	57.7	55.7	54.4	53	53	53	53	52
	1650	63	63	63	59.3	56.8	54.6	52.4	50.4	47.9	47.2	46	45.1	45.1
	1743	61	61	61	57.3	54.8	52.8	50.4	46.7	41	40.7	42.6	43.2	43.1
	1911	58.5	58.5	58.5	54	51.5	49.5	47.6	45.7	39.2	38	38.2	39.3	38.3
	2058	56.5	56.5	56.5	51.6	49.1	46.9	45.1	43.2	38.7	36.2	33.9	34	35
	2247	54	54	54	48.9	46.9	44.9	42.7	40.9	34.2	33.7	32.4	31.5	30.2
	2499	51	51	51	46.5	44.5	42.5	40.2	38.2	31.9	32	31.3	30	29.5
	3003	50	49	47.2	43.1	41.2	39.2	36.7	34.7	30.2	29.7	28.9	28.9	27.9
	3507	48.4	46.4	43.8	39.9	37.3	35.3	32.6	30.4	29	27.5	26.5	26.5	27
3990	46.9	43.4	40.3	36.7	34.6	32.6	30.1	27.3	26	25.5	25	25.5	25.5	
4242	45.9	41.9	38.5	35.4	33.2	31.54	25	25	25	24.5	25	25	24.5	

Table 5.23: N75 Duty Cycle for Octavia

(Z) N75 duty cycle		(I.Q) (0 - 58) mg/stroke												
		0	5	10	15	20	25	30	35	40	45	50	55	58
engine rpm	760	75	75	75	80	80	80	80	80	80	80	80	80	80
	780	75	75	75	80	80	80	80	80	80	80	80	80	80
	1000	75	75	75	80	80	80	80	80	80	80	80	80	80
	1150	69	69	69	80	80	80	80	80	80	80	80	80	80
	1300	69	69	69	74.9	74.9	74.9	74.9	74.9	74.9	74.9	74.9	74.9	74.9
	1500	68.5	68.5	68.5	68.5	68.5	68.5	68.5	67.5	65	61	57.3	53.8	51.3
	1650	67.5	67.5	67.5	67.5	66.8	65.7	63.9	61.4	58.4	55.8	52.8	50.1	47.6
	1743	66.7	66.7	66.7	66.2	64.6	62.6	61.2	58.4	55.2	52.5	50.3	47.7	45.6
	1911	65	65	64.8	64	61	58.8	56.9	54.4	51.9	49.5	47.5	45.3	43.3
	2058	64	64	63.2	62.6	58.9	56.2	54.4	51.9	49.4	47	45.2	43.3	41.5
	2247	62.5	62.3	61.7	60.6	56.5	52.7	50.9	49.2	46.4	44.5	42.7	41	39.5
	2499	62	61.7	61.2	58.5	53.6	50	47.2	45.7	43.4	41.5	39.8	38.5	37.5
	3003	56.9	56.9	55.7	51.2	46.2	43	41.2	39.7	37.7	36	34.5	33.5	32.5
	3507	52.5	52.5	48.3	42.4	39.8	37.8	36.1	34.9	33.2	31.5	30	29	28
3990	50.5	50.5	44	38.7	35.6	33.6	32.1	30.8	29.4	28	26.5	25.5	24.5	
4242	49.5	49.5	42.8	36.9	33.7	32	30.3	29.2	28	26.5	25	24	23	



Table 5.24: N75 duty cycle percentage difference between Octavia and Fabia

(Z) N75 duty cycle Percentage difference		(I.Q) (0 - 58) mg/stroke												
		0	5	10	15	20	25	30	35	40	45	50	55	58
engine rpm	760	1.00	1.00	1.00	1.00	1.00	1.00	1.00	1.00	1.00	1.00	1.00	1.00	1.00
	780	1.00	1.00	1.00	1.00	1.00	1.00	1.00	1.00	1.00	1.00	1.00	1.00	1.00
	1000	1.00	1.00	1.00	1.00	1.00	1.00	1.00	1.00	1.00	1.00	1.00	1.00	1.00
	1150	0.92	0.92	0.92	1.00	1.00	1.00	1.00	1.00	1.00	1.00	1.00	1.00	1.00
	1300	0.96	0.96	0.96	1.04	1.04	1.04	1.09	1.15	1.21	1.25	1.25	1.25	1.25
	1500	1.04	1.04	1.04	1.09	1.15	1.19	1.23	1.24	1.23	1.15	1.08	1.02	0.99
	1650	1.07	1.07	1.07	1.14	1.18	1.20	1.22	1.22	1.22	1.18	1.15	1.11	1.06
	1743	1.09	1.09	1.09	1.16	1.18	1.19	1.21	1.25	1.35	1.29	1.18	1.10	1.06
	1911	1.11	1.11	1.11	1.19	1.18	1.19	1.19	1.19	1.33	1.30	1.24	1.15	1.13
	2058	1.13	1.13	1.12	1.21	1.20	1.20	1.21	1.20	1.28	1.30	1.33	1.27	1.19
	2247	1.16	1.15	1.14	1.24	1.20	1.17	1.19	1.20	1.36	1.32	1.32	1.30	1.31
	2499	1.22	1.21	1.20	1.26	1.21	1.18	1.17	1.20	1.36	1.30	1.27	1.28	1.27
	3003	1.14	1.16	1.18	1.19	1.12	1.10	1.12	1.15	1.25	1.21	1.19	1.16	1.16
	3507	1.09	1.13	1.10	1.06	1.07	1.07	1.11	1.15	1.14	1.15	1.13	1.09	1.04
	3990	1.08	1.16	1.09	1.05	1.03	1.03	1.07	1.13	1.13	1.10	1.06	1.00	0.96
4242	1.08	1.18	1.11	1.04	1.02	1.02	1.21	1.17	1.12	1.08	1.00	0.96	0.94	

The change in N75 duty cycle MAP is in accordance with:

- The increase of smoke limit MAP of Octavia and the upper limit set in smoke MAP of Octavia (1076 mg/stroke) compared with Fabia (1051 mg/stroke).
- The increase of torque limits MAP in Octavia compared with Fabia.
- The increase of maximum boost pressure in boost limiting MAP between Octavia (2500 mbar) and Fabia (2350 mbar).

## **Chapter Six**

## CH 6: Conclusion and Recommendations

### 6.1. Conclusion

The modern engine technology allows the Electronic Control Unit (ECU) to monitor and control the entire engine operation in order to meet the legislative requirements. The control strategy of ECU is based on the stored MAPs.

In the present study the diesel engine management is presented, the ECU contains a set of MAPs that regulates the fuel amount and boost pressure. Some of the MAPs work as a lookup table while the others work as a limiting condition. The main reason behind the use of limiting MAPs is to protect the entire power train from engine to tires.

In the case study provided, the ECU MAPs stored in Octavia and Fabia are extracted and compared:

- The main fuel amount (I.Q) is determined by the driver wish MAP, this amount is limited by two other factors: the smoke limit and torque limit.
- The boost pressure is determined by the boost MAP, this pressure is limited by two factors: boost limit and N75 duty cycle.
- The MAPs stored in Octavia are similar to those of Fabia, except of some modifications (increase) which range between 3% up to 36% in the several MAPs studied.
- The several changes done in Octavia MAPs will allow for: steady idle, better acceleration performance, more responsive turbo charging and better fuel utilization with a higher power output.

## **6.2 Recommendations**

The field of ECU tuning is demanding in the local market, with a huge lake of qualified professionals in this field. We recommend the following:

- ECU tuning must be performed and verified by qualified professionals
- Caution should be used in any modifications on MAPs since these modifications may cause serious problems with safety of the entire power train.
- The university must fill the gap in the local market by providing specialized workshops and training programs.
- The university should develop a new course within the automotive engineering curricula for ECU tuning.
- The ministry of transportation must control the ECU tuning because harmful impact on the environment may arise.

## References

- [1] . Electronic Control Unit of Fuel Injection System, University Tun Hussein On Malaysia, 2013
- [2] . Nicolay Sebastian , Microcontrollers Hardware, Software and Applications , Cambridge university ,1998.
- [3] . Bosch Automotive Electrics and Automotive Electronics , Robert Bosch GmbH , 5th Edition ,2002 .
- [4] . Bosch Automotive hand bock , first edition , March 2000.
- [5] . WinOLS software of MAP tuning, <http://www.evc.de/en/product/ols/software/>.